



An American Company



# TOOLING SOLUTIONS

## TOOLHOLDERS & ACCESSORIES

YOUR SUCCESS HANGS ON THE RELIABILITY OF EVERY COMPONENT.



Techniks is a proud member of Techniks Tool Group.

**TOOLING SOLUTIONS FROM SPINDLE TO WORKPIECE**

Connect with Techniks Tool Group





# TECHNIKS CNC TOOLING SOLUTIONS - FROM SPINDLE TO WORKPIECE

You know we make toolholders, but did you know we will work closely with you to understand your manufacturing needs, so we can provide the best possible solutions? Becoming a Techniks customer means you have an expert solutions partner who provides top quality products and excellent customer service backed by our satisfaction guarantee.

## WITH TECHNIKS YOU GET:

- Inspected, tested and lab-certified products that provide outstanding value and extend perishable cutting tool life to save you money.
- Full factory support before, during, and after the sale
- Guaranteed turn-key CNC tooling and workholding solutions
- Live phone support (toll-free) 7:00 am – 6:00 pm E.S.T.
- Orders ship the same day they are received! (ground orders received by 2:00 pm, or expedited orders received by 5:00 pm)
- Each order is checked 4 times before shipping. 99.9% average shipping accuracy (we track this each month)
- All products are backed by our 100% satisfaction guarantee
- Training on how to use our products if needed
- 24/7 access to request a quote, look up product information, request catalogs, on the web ([www.techniksusa.com](http://www.techniksusa.com))
- Receive promotions and product information by opt-in email

The entire Techniks team is committed to excellent customer service for fast and accurate fulfillment of orders. Thank You for considering Techniks for your CNC tooling needs.

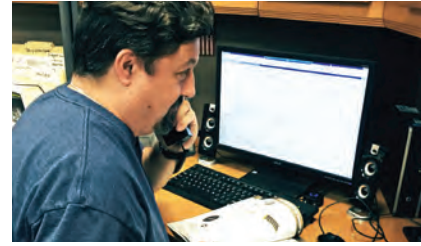

Live phone support M-F, 7:00 am – 6:00 pm EST



Orders ship the same day they are received.



RoadShow live product demos at your facility.

## CONTACT INFORMATION

Toll-Free: 800.597.3921

Local: 317.803.8000

Email: [info@techniksusa.com](mailto:info@techniksusa.com)

Website: [www.techniksusa.com](http://www.techniksusa.com)

Hours: M-F, 7:00 am – 6:00 pm EST

Techniks Inc., 9930 E. 56th St.

Indianapolis, IN 46236





# TECHNIKS CNC TOOLING SOLUTIONS - FROM SPINDLE TO WORKPIECE



## TECHNIKS CERTIFIED CNC TOOLING SOLUTIONS QUALITY & PERFORMANCE GUARANTEED

### TAPER ACCURACY AT3

Taper ground to AT3 accuracy for maximum contact with spindle.

### BALANCED TO 25,000 RPM @ G2.5

Custom balancing to 60,000 RPM available for optimal performance.

### BALANCED NUT

Balanced nut reduces vibration to extend cutting tool life.

**Lab Certified Accuracy**  
Each toolholder is lab certified for accuracy and balance.

**Taper-to-Pocket T.I.R. 0.0001"**  
Measured from taper O.D. to collet pocket I.D.



**Ultra Precision Collet**  
Each collet hand inspected. T.I.R. only 0.0002"



**PowerCOAT Nuts**  
Our PowerCOAT nut holds 70% tighter than standard nuts for best T.I.R. and rigidity.



WITH TECHNIKS YOUR SUCCESS HANGS ON THE RELIABILITY OF EVERY COMPONENT.  
TECHNIKS PRODUCTS ARE BACKED BY OUR 100% SATISFACTION GUARANTEE.

### TECHNIKS CERTIFIED END MILL HOLDERS

Best in the industry H5 bore tolerance improves accuracy and extends tool life.

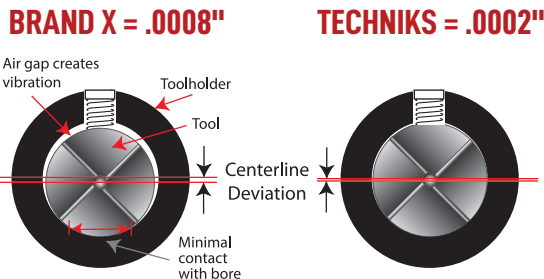

### A FULL REPORT COMES WITH EACH HOLDER

INSPECTION REPORT	
MODEL NO : SYIC-	Balanced to G2.5 25,000 RPM
COMMODITY : ISK/ER COLLET CHUCK TYPE F	
TYPE :	
UNIT:mm	
ITEM EXAMINED	CON V 60631-6 Tolerance Standard
APPROVED	HSK50F #30 ±0.002 #70.00 ±0.008 11.42±0.010
TOLERANCE	HSK50F #30 ±0.002 #36.90 ±0.008 14.13±0.010
TEST VALUE	#48 ±0.002 #48.53 ±0.008 18.13±0.010
Operator:	DATE: JUL 15 2004

TEST REPORT OF BALANCE	
MODEL NO : SYIC-T5-10000-N	ALLOWABLE UNBALANCE
COMMODITY : HSK63H-ER32-70	PER ISO 1940 SPECIFICATION 0.5 g mm
TYPE :	RESIDUAL UNBALANCE ASSEMBLED < 7 g mm
OPERATION: G2.5 RPM 24500 W 0.0008 D.76 Wg	IS ONLY SHANK < 7 g mm
PERFORMA : UNBALANCE = 0.00031442	□ SHAKE WITH NUT < 7 g mm
MEASURED TOP :	□ SHAKE WITH COLLET AND PIN < 7 g mm
UNBALANCE BOTTOM :	
WRITE : ( USE THE TOLERANCE AS FOLLOWS )	
WHEN L < 100 mm MEASURED BY 1 FLAKE ( BOTTOM )	
L > 100 mm MEASURED BY 2 FLAKE ( TOP & BOTTOM )	
SYIC-T5-10000-N	
HSK63H-ER32-70	
G2.5	0.024000 g mm
DATE: 07/15/04	
Operator: [Signature]	
DATE: 07/15/04	
Measuring disk for top balancing plane	
Measuring disk for bottom balancing plane	



We stand behind all our products with our 100% Satisfaction Guarantee • www.techniksusa.com



**NEW!**



## TRITON HYDRAULIC CHUCKS

Unleash the Hydraulic  
Power of Triton Chucks!

Triton hydraulic chucks provide unmatched clamping power and excellent vibration damping. Use reduction sleeves to hold a variety of shank diameters.

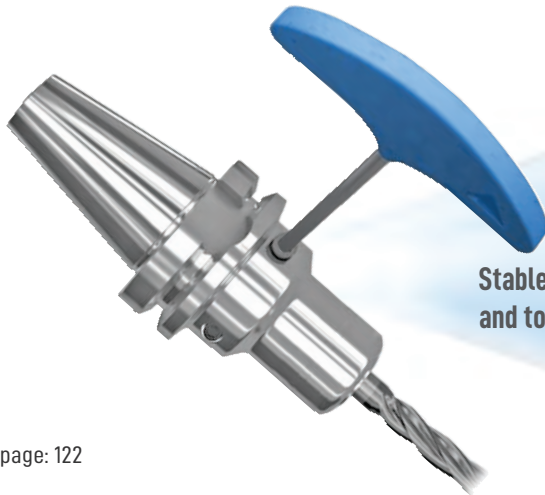

Stable clamping between holder and tool through hydraulic force

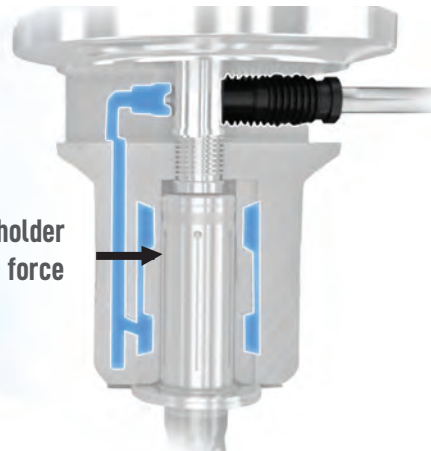

page: 122

page: 230

**NEW!**



## MegaFORCE

MEGAFORCE HIGH-TORQUE RETENTION KNOBS  
SUPERIOR PERFORMANCE AND SAFETY!

### FEATURES

- Rolled threads maintain material grain structure improving thread strength up to 20%
- Each MegaFORCE Retention knob is magnetic particle tested to ensure material integrity and physical soundness
- Tested at 2.5X the pulling forces of the drawbar



# IT'S NOT JUST SHRINKFIT. IT'S SHRINKLOCKED!



**SHRINK LOCKED™**  
WITH FORMULA TTG 594

PATENTED COATING FORMULA FOR UNBREAKABLE HOLDING FORCE.

**Upgrade ShrinkFIT Holders to ShrinkLOCKED!**  
Techniks patented TTG-594 coating provides **6X** the gripping force of standard shrinkFIT.

## Why Try ShrinkLOCKED?

- Run harder – higher speeds and feeds.
- Never spin or pull out a cutting tool.
- No modification to your tool shank required.
- No impact to accuracy or tool changes.
- Locked drive on standard carbide round shanks.

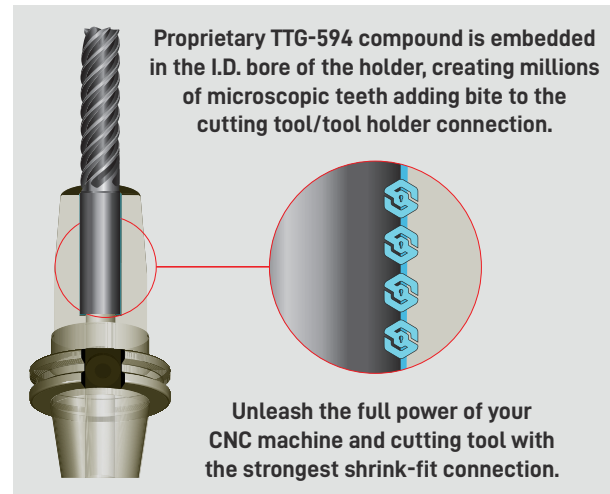

## SHRINKSTATION 00450

Compact & Powerful Heat Shrink Technology

### Small Size, BIG RESULTS!

Techniks 00450 ShrinkSTATION is loaded with features that make it the easiest-to-use, and most powerful compact shrink-fit machine.

- **Upgraded induction coil technology** enables **fast tool changes** in 6-8 seconds.
- **Auto-positioning** pedestal perfectly aligns tool holder into induction head.
- **Easy-to-use** touch screen: Just set the tool diameter and GO!
- **Compact design** easily fits virtually anywhere!
- Works on **all brands** of shrink fit tool holders
- Made in the **USA** durability!



page: 119







## COLLET CHUCKS

**Pages: 9-42**

Balanced to 25,000 RPM @ G2.5, 0.0001" max. T.I.R., include a PowerCOAT nut for increased holding power.

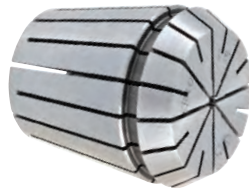

## COLLETS & NUTS

**Pages: 43-72**

The broadest selection of ER, TG, and DA collets including standard, steel-sealed, coolant, rigid & floating tap, and DNA (Dead Nuts Accurate).



## END MILL HOLDERS

**Pages: 73-94**

H5 bore tolerance is the best in the industry to reduce run-out and improve cutting performance and tool life.



## SHRINKFIT TOOLS

**Pages: 95-120**

Made from H13 steel for long-lasting, reliable performance. Available with CoolBLAST coolant ports and DIN-B coolant delivery.



## HYDRAULIC HOLDERS

**Pages: 121-130**

Highest clamping pressure of any hydraulic chuck. Provides repeatable accuracy of <.0001", with smooth cutting performance.



## MILLING CHUCKS & OTHER HOLDER TYPES

**Pages: 131-142**

Extreme clamping pressure and accuracy. Use reducing sleeves for any shank size for maximum flexibility.



## FACE MILL ARBORS

**Pages: 143-152**

H6 arbor tolerance is the best in the industry and ensures the most accurate fit with the face mill cutter for superior cutting performance.



## PSC HOLDERS

**Pages: 153-162**

Wide variety of Capto\*-compatible tooling including collet chucks, end mill holders, shrink fit holders, face mill arbors, and insert holders.



## TAPPING TOOLS

**Pages: 163-174**

MicroFLOAT synchronous tapping system, Tension/Compression, and Rigid options to meet any tapping application.





## BORING TOOLS

**Pages: 175-228**

Rigid & easy-to-use modular boring from .314" to 40.157". Roughing and finishing head options and modular BohrSTAR boring kits.



## RETENTION KNOBS

**Pages: 229-234**

A large selection for any machine, made from aircraft-quality AMS-6274 alloy steel, all mating surfaces precision ground.



## SETUP EQUIPMENT

**Pages: 235-242**

Everything you need to set-up your tooling including tightening stands, torque wrenches, retention knob sockets, and preset gauges.

**MagVISE**  
magnetic workholding



## EEPM MAGNETIC CHUCKS

**Pages: 243-258**

Reduce set-up time by over 50% and enable 5-sided machining. Standard and engineered turn-key solutions for any application.

**MagVISE**  
**E-C-B**  
WORKHOLDING  
VISES

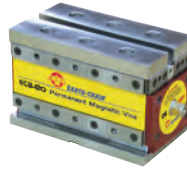

## ECB MAGNETIC VISES

**Pages: 259-260**

Powerful and modular, ECB magnetic vises can be used individually or in ganged set-ups for larger, complex workpieces.

**EZ**  
LIFT



## ELM MAGNETIC LIFTERS

**Pages: 268-270**

3.5x safety factor ensures the ability to safely lift flat or round stock up to 6,600 lbs. Permanent magnets do not wear out like straps and slings.



**the SPINner**

## SPINNER MAGNETIC DEBURRING MACHINES

**Pages: 271-274**

Eliminate hand deburring of precision metal parts. Unique magnetic media removes burrs and improves surface finishes even on the ID of parts.

**SEND US YOUR PARTS FOR FREE TESTING. SEE THE SPINNER WORK FOR YOU!**

Our deburring specialist will provide a complete report. Includes specific media used & average deburring time.



# TABLE OF CONTENTS

## COLLET CHUCKS

### CAT ER COLLET CHUCKS

CAT40 Collet Chucks .....	10
CAT40 CoolFLEX .....	11
CAT40 Mini Nut .....	12
CAT40 SuperRIGID .....	13
CAT40 DualDRIVE .....	14
CAT50 Collet Chucks .....	15
CAT50 CoolFLEX .....	16
CAT50 Mini Nut .....	17
CAT50 SuperRIGID .....	18
CAT50 DualDRIVE .....	19

### BT ER COLLET CHUCKS

BT30, BT35 Collet Chucks .....	20
BT30 DualDRIVE, Mini Nut .....	21
BT40 Collet Chucks, DualDRIVE.....	22
BT40 CoolFLEX .....	23
BT40 Mini Nut .....	24
BT40 SuperRIGID.....	25
BT50 Collet Chucks .....	26

### HSK ER COLLET CHUCKS

HSK63A, HSK32A, HSK40A, HSK50A Chucks .....	27
HSK32E, HSK40E, HSK50E, HSK63E, HSK50F, HSK63F Chucks .....	28
HSK100A Collet Chucks .....	29

### TG & ISO COLLET CHUCKS

TG75, TG100 Chucks .....	30
ISO20, ISO25, ISO30, SK30 Chucks .....	31

### STRAIGHT SHANK ER EXTENSIONS

Straight Shank Extensions.....	32
Mini Nut Extensions, Mini Nut Coolant-Thru Extensions ...	33
Straight Shank Extensions Coolant, Double-Ended Extensions .....	34

### SLIMFIT COLLET CHUCKS

CAT SlimFIT Chucks .....	36
BT SlimFIT Chucks .....	37
HSK63A SlimFIT Chucks .....	38
SlimFIT Extensions .....	39
SlimFIT Collets .....	40
Coolant Preset Screws & Torque Chart .....	41
Special Order Form.....	42

## COLLETS & NUTS

### ER COLLETS

ER Collets - Inch .....	44
ER Collets - Metric.....	46
"Dead Nuts Accurate" DNA Collets.....	48
ER Steel Sealed - Inch.....	50
ER Steel Sealed - Metric .....	51
ER Steel Sealed - CoolBLAST.....	52
ER Coolant Collets.....	53

### TAP COLLETS

ER Rigid Tap Collets - Inch.....	54
ER Rigid Tap Collets - Metric .....	55
ER Steel Sealed Rigid Tap Collets.....	56
ER Quick-Change Collets.....	58
ER Floating Tap Collets .....	59
SlimFIT Style Collets .....	60
Collet Storage Trays.....	61

### POWERCOAT NUTS

PowerCOAT Nuts.....	62
PowerCOAT Mini Nuts .....	63

### BLACK GOLD COOLANT RINGS

ER Coolant Rings.....	64
-----------------------	----

### TG COLLETS & NUTS

TG75 Collets and Nut .....	66
TG100 Collets and Nut.....	67
TG100 Coolant Collets .....	68
TG150 Collets.....	69

### OTHER COLLETS

SY0Z / EOC Collets .....	70
Double Angle DA Collets .....	71

### COLLET SPECIFICATIONS

Collet I.D. Guide.....	72
------------------------	----

## END MILL HOLDERS

### CAT END MILL HOLDERS

CAT40 Stubby Length .....	74
CAT40 Standard - Inch & Metric.....	75
CAT40 Extended Length, Rigid Reach ..	76
CAT40 CoolBLAST, CAT40 Rigid Reach w/CoolBLAST .....	77
CAT40 CoolBLAST w/CoolFLEX.....	78
CAT40 CoolFLEX.....	79
CAT40 DualDRIVE.....	80
CAT40 DualDRIVE w/CoolBLAST .....	81
CAT50 Stubby Length .....	82
CAT50 Standard - Inch & Metric.....	83
CAT50 Extended Length, Rigid Reach ...	84
CAT50 CoolBLAST, Rigid Reach w/CoolBLAST .....	85
CAT50 CoolFLEX.....	86
CAT50 DualDRIVE, DualDRIVE w/CoolBLAST .....	87

### HSK END MILL HOLDERS

HSK63A, HSK63F .....	88
HSK100A.....	89

### BT END MILL HOLDERS

BT30 Standard - Inch, DualDRIVE .....	90
BT40 Standard - Inch & Metric.....	91
BT40 Extended Length, Rigid Reach....	92
BT40 CoolFLEX, BT50 Standard - Inch.....	93

### END MILL LOCK SCREWS

Replacement Set Screws .....	94
------------------------------	----

## SHRINKFIT TOOLING

### CAT SHRINKFIT HOLDERS

CAT40 ShrinkFIT - Inch .....	96
CAT40 ShrinkFIT - Metric, SlimPRO .....	97
CAT40 CoolBLAST, CoolFLEX .....	98
CAT40 CoolBLAST w/CoolFLEX .....	99
CAT40 DualDRIVE w/CoolFLEX .....	100
CAT40 DualDRIVE w/CoolFLEX & BLAST .....	101
CAT50 Standard - Inch .....	102
CAT50 Standard - Metric .....	103
CAT50 CoolBLAST .....	104
CAT50 DualDRIVE w/CoolFLEX .....	105

### BT SHRINKFIT HOLDERS

BT30 Standard - Inch, DualDRIVE .....	106
BT40 Standard - Inch & Metric .....	107
BT40 DualDRIVE, w/CoolFLEX .....	108

### HSK SHRINKFIT HOLDERS

HSK63A Inch & Metric .....	109
HSK63A CoolBLAST, SlimPRO .....	110
HSK100A Standard .....	111
HSK100A CoolBLAST .....	112
HSK40E Standard, SlimPRO .....	113
HSK63F, HSK50E Holders .....	114

### ISO30 SHRINKFIT HOLDERS

ISO30 ShrinkFIT Holders .....	115
-------------------------------	-----

### SHRINKFIT EXTENSIONS & COOLANT SET SCREWS

ShrinkFIT Extensions, Coolant Preset Screws .....	115
--	-----

### SFS12 MODULAR SHRINKFIT

SFS12 Holders .....	116
SFS12 Adapters - Inch .....	117
SFS12 Adapters - Metric .....	118

### SHRINKFIT MACHINES

00400, 00450 ShrinkSTATIONS .....	119
00600 ShrinkPRO, 00500 Quencher .....	120

## HYDRAULIC HOLDERS

### TRITON HYDRAULIC HOLDERS

About Triton Hydraulic Holders .....	122
CAT40, CAT50 Triton Holders .....	124
HSK63A, HSK100A, BT30, BT40 Triton Holders .....	125

### SLIM STYLE HYDRAULIC HOLDERS

CAT40 Standard, Extended .....	126
CAT50, BT30, BT40 .....	127
HSK63A, HSK63F .....	128
HSK100A .....	129
Reduction Sleeves .....	130

## MILLING CHUCKS

CAT40, CAT50 .....	132
CAT40, CAT50 DualDRIVE .....	133
BT40, HSK63A, HSK100A .....	134
Reduction Sleeves .....	135

## OTHER HOLDER TYPES

### TOOL BLANKS

CAT40, CAT50, HSK63A, HSK100A .....	136
-------------------------------------	-----

### MORSE TAPER HOLDERS

CAT40, CAT50, BT30, BT40, BT50 .....	137
--------------------------------------	-----

### SIMIS HOLDERS

CAT40, CAT50 Simis Collet Chucks .....	138
CAT 40, CAT50 Simis End Mill Holders .....	139

### DRILL CHUCKS

HP3 High Precision Drill Chucks, Keyless Jacobs Drill Chucks .....	140
Keyless CAT, BT, SPU Chucks .....	141
Jacobs Taper Drill Chucks .....	142

## FACE MILL ARBORS

CAT40 Face Mill Arbors .....	144
CAT40 DualDRIVE .....	145
CAT50 Face Mill Arbors .....	146
CAT50 DualDRIVE .....	147
BT30 Standard & DualDRIVE .....	148
BT40 Face Mill Arbors, BT50 Standard & DualDRIVE .....	149
HSK63A, HSK63F Face Mill Arbors .....	150
HSK100A, R8 Face Mill Arbors .....	151
Arbor Screws .....	152

## PSC HOLDERS

C4, C5, C6 Collet Chucks .....	154
C4, C6 SlimFIT Chucks .....	155
C4, C6 End Mill Holders .....	156
C4, C5, C6 ShrinkFIT Holders .....	157
C4, C5, C6 Face Mill Arbors .....	158
C6 Turning Tools .....	159

## TAPPING TOOLS

### MICROFLOAT

#### SYNCHRONOUS TAPPING

About MicroFLOAT .....	164
MicroFLOAT Holders & Adapters .....	166
Rigid Tap Collets for MicroFLOAT .....	167

#### TENSION/COMPRESSION

CAT, BT Holders .....	168
HSK, Straight Shank Holders .....	169

#### RIGID TAP

CAT, BT Holders .....	170
HSK, Straight Shank Holders .....	171

#### ANSI SPEC TAP COLLETS

ANSI Rigid Tap Collets .....	172
ANSI Clutch Drive Tap Collets .....	173
Tightening Torque Specifications .....	174



# TABLE OF CONTENTS

## BORING TOOLS

### BOHRSTAR KITS

BohrSTAR 43 Kit - Triangular Inserts	176
BohrSTAR 43 Kit - Rhombic Inserts	177
BohrSTAR 100 Kit - Triangular Inserts	178
BohrSTAR 100 Kit - Rhombic Inserts	179
BohrSTAR 170 Kit - Triangular Inserts	180
BohrSTAR 170 Kit - Rhombic Inserts	181
BohrSTAR 210 Kit - Triangular Inserts	182
BohrSTAR 210 Kit - Rhombic Inserts	183
BohrSTAR Kit Holders & Inserts	184

### MODULAR BORING TOOLS

Modular Boring Overview	185
Micro Heads, Boring Bars	189
75 ° Roughing Heads	192
90 ° Roughing Heads	194
75 ° Finishing Heads	196
90 ° Finishing Heads	198
75 ° UltraFINE Finishing Heads	200
90 ° UltraFINE Finishing Heads	201

### CARTRIDGES & INSERTS

Indexable Cartridges	202
Boring Inserts	204

### BORING HEAD HOLDERS

CAT40 Holders	206
CAT40 Coolant-thru Holders	207
CAT50 Holders	208
CAT50 Coolant-thru Holders	209
BT30, BT40 Holders	210
BT50 Holders	211
HSK50A, HSK63A, HSK100A Holders	212
Weldon, R8 Holders	213
Large Head Mount Toolholders	214

### MODULAR HOLDERS & ADAPTERS

Extensions	216
Chamfering Heads, Reducers	217
End Mill, Face Mill Adapters	218

### MACROBOHR LARGE HOLE BORING

MacroBOHR System Overview	219
Mounting Plates & Accessories	221
Mount Holders & Adapters	222
Speeds & Feeds	223
Spare Parts	224
Boring Tool Selection Guide	228

## SETUP EQUIPMENT

### RETENTION KNOBS

MegaFORCE Retention Knobs	230
CAT40, CAT50 Solid, Coolant Retention Knobs	232
BT30, BT40, BT50 Solid, Coolant, DIN 69871-A/B Retention Knobs	233
Retention Knobs for CNC Routers	234

### WRENCHES

Wrenches for Collet Nuts	236
Adjustable Torque Wrenches, Torque Wrench Adapters	237

### OTHER SETUP EQUIPMENT

Tightening Fixtures	238
Spindle Wipers, Preset Gauges	239
Preset Screws, HSK Coolant Pipes, Wrenches	240
Test Bars, Calibration Tools	241
Indicator Arms	242

## MAGNETIC WORKHOLDING

### MAGVISE EEPM WORKHOLDING

About EEPM Chucks	245
EEPM CNC Chucks	246
EEPM Induction Blocks	247
EEPM Chucks - Thick Workpieces	248
EEPM Chucks - Thin Workpieces	249
EEPM-C Modular Chucks	250
EEPM-V Horizontal Machining	252
EEPM-CIR Vertical Turning	254
EEPM-CIRS Round	256
EEPM-IT Index Table	257
EEPM-PIM Injection Mold	258

### ECB MAGNETIC VISES

ECB Workholding Vises	259
-----------------------	-----

### SURFACE GRINDING CHUCKS

EDMT Variable Pole	261
EDTW Fine-Pole	262
EET Wide Pole	263
EET-W Fine Pole	264
Induction Blocks	265
Magnetic V-Blocks	266
Chuck Controllers & Demagnetizers	267

## MAGNETIC LIFTERS

### EZ-LIFT MAGNETS

ELM Lifting Magnets	268
Spreader Bars & Vertical Lifters	269
Calculating Loads & Custom Solutions	270

## SPINNER DEBURRING

### SPINNER MACHINE INFO. & PARTS

Parts Deburring Service	271
sPINner Features & Examples	272
sPINner Operations Guide	273
sPINner Machines, Media Pins, Separator, and Solution	274

## PART NUMBER INDEX

Products by part number	275
-------------------------	-----



# TECHNIKS CERTIFIED COLLET CHUCKS

## QUALITY & PERFORMANCE GUARANTEED

Techniks Certified means the critical features of each holder has been individually lab tested, measured and inspected for quality. Techniks Certified guarantees your holder will meet or beat our published specifications.

### TAPER ACCURACY AT3

Taper ground to AT3 accuracy for maximum contact with spindle.

### BALANCED TO 25,000 RPM @ G2.5

Custom balancing to 60,000 RPM available for optimal performance.

### BALANCED NUT

Balanced nut reduces vibration to extend cutting tool life.

#### Lab Certified Accuracy

Each toolholder is lab certified for accuracy and balance.

#### Taper-to-Pocket T.I.R. 0.0001"

Measured from taper O.D. to collet pocket I.D.

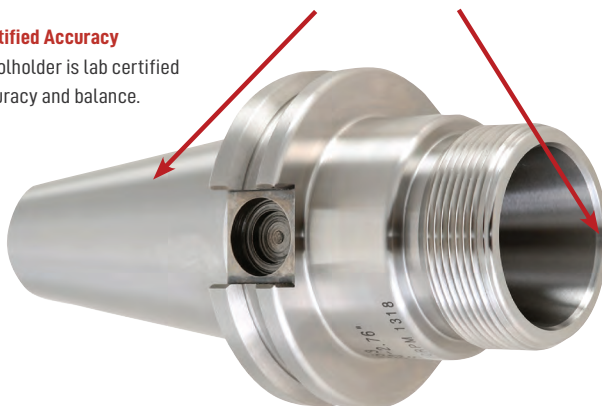

#### Ultra Precision Collet

Each collet hand inspected. T.I.R. only 0.0002"



#### PowerCOAT Nuts

Our PowerCOAT nut holds 70% tighter than standard nuts for best T.I.R. and rigidity.



**WITH TECHNIKS YOUR SUCCESS HANGS ON THE RELIABILITY OF EVERY COMPONENT.  
TECHNIKS PRODUCTS ARE BACKED BY OUR 100% SATISFACTION GUARANTEE.**



**YOU LOSE 10% OF TOOL LIFE FOR EVERY .0001" OF T.I.R.  
TECHNIKS COLLET CHUCKS EXTEND CUTTING TOOL LIFE.**





# CAT40 ER COLLET CHUCKS



pg. 44



pg. 62



pg. 64



pg. 229



pg. 236



pg. 238



## FEATURES

- Balanced to 25,000 RPM at G2.5
- Maximum 0.0001" T.I.R. measured from taper to collet pocket
- PowerCOAT Nut increases holding power by 75%

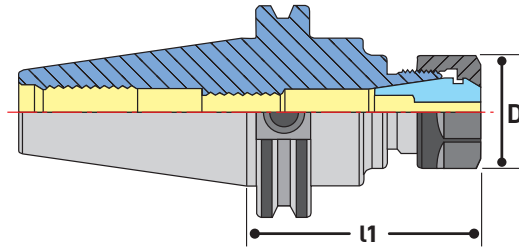

Coolant Stop Screws page 41.

 Techniks Certified for accuracy and balance. Each holder comes with a complete lab report. PowerCOAT nut is included with each holder.

## CAT40 ER COLLET CHUCKS

Part No.	Description	L1	D	Max. Shank	Stop Screw	Wrench	Nut
22213-3	CAT40 x ER11 - 3", hex nut	3"	.748"	.275"	16081	04608	41111
22225	CAT40 x ER16 - 2.76", hex nut	2.76"	1.08"	.406"	16083	04609	41116
22227	CAT40 x ER16 - 4", hex nut	4"	1.08"	.406"	16083	04609	41116
22231	CAT40 x ER16 - 6", hex nut	6"	1.08"	.406"	16083	04609	41116
22233	CAT40 x ER16 - 8", hex nut	8"	1.08"	.406"	16083	04609	41116
22233-10	CAT40 x ER16 - 10", hex nut	10"	1.08"	.406"	16083	04609	41116
22235	CAT40 x ER20 - 2.76", hex nut	2.76"	1.34"	.512"	16087	04610	41120
22237	CAT40 x ER20 - 4", hex nut	4"	1.34"	.512"	16087	04610	41120
22239	CAT40 x ER20 - 6", hex nut	6"	1.34"	.512"	16087	04610	41120
22239-8	CAT40 x ER20 - 8", hex nut	8"	1.34"	.512"	16087	04610	41120
22239-10	CAT40 x ER20 - 10", hex nut	10"	1.34"	.512"	16087	04610	41120
22243-2.5	CAT40 x ER25 - 2.5", slotted nut	2.5"	1.65"	.630"	16089	04615	41925
22243	CAT40 x ER25 - 2.76", slotted nut	2.76"	1.65"	.630"	16089	04615	41925
22245	CAT40 x ER25 - 4", slotted nut	4"	1.65"	.630"	16089	04615	41925
22247	CAT40 x ER25 - 6", slotted nut	6"	1.65"	.630"	16089	04615	41925
22251	CAT40 x ER25 - 8", slotted nut	8"	1.65"	.630"	16089	04615	41925
22253	CAT40 x ER32 - 2.76", slotted nut	2.76"	1.97"	.788"	16089	04616	41932
22255	CAT40 x ER32 - 4", slotted nut	4"	1.97"	.788"	16089	04616	41932
22257	CAT40 x ER32 - 6", slotted nut	6"	1.97"	.788"	16089	04616	41932
22259	CAT40 x ER32 - 8", slotted nut	8"	1.97"	.788"	16089	04616	41932
22259-10	CAT40 x ER32 - 10", slotted nut	10"	1.97"	.788"	16089	04616	41932
22261	CAT40 x ER40 - 3.15", slotted nut	3.15"	2.48"	1.023"	16091	04617	41940
22263	CAT40 x ER40 - 4", slotted nut	4"	2.48"	1.023"	16091	04617	41940
22265	CAT40 x ER40 - 6", slotted nut	6"	2.48"	1.023"	16091	04617	41940
22269	CAT40 x ER50 - 4", slotted nut	4"	3.07"	1.338"	16093	04618	41950

**Slot Nut Option:** Add "-SLOTNUT" to part number for ER16 and 20 slotted nuts

**Coolant Nut Option:** Add "-C" to part number. Coolant nuts are not available for ER50.

**DNA Option:** Add "-DNA" (ER16, ER20, & ER32)



## FEATURES

- Balanced to 25,000 RPM at G2.5
- Maximum 0.0001" T.I.R. measured from taper to collet pocket
- PowerCOAT Nut increases holding power by 75%

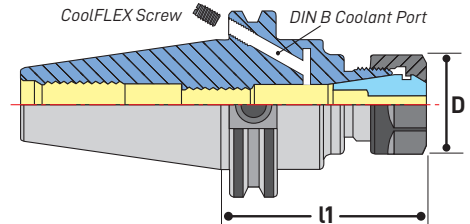

 Techniks Certified for accuracy and balance. Each holder comes with a complete lab report. PowerCOAT nut is included with each holder.



### TRY TECHNIKS DEAD NUTS ACCURATE DNA COLLETS & NUTS SYSTEM

For shank sizes 1/8" (3mm) or smaller use our DNA (dead nuts accurate) collets for improved results.

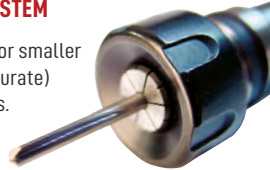
See page 48.



### COOLFLEX FEATURE

CoolFLEX holders are factory set for coolant-thru spindle. Remove the stop screws for DIN B coolant-thru flange.

Part No.	Description
HSA-4-6	40 taper DIN B screw

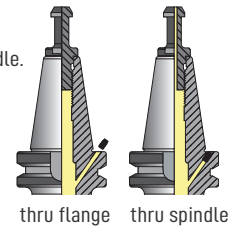

## CAT40 ER COLLET CHUCKS COOLFLEX

Coolant Stop Screws page 41.

Part No.	Description	l1	D	Max. Shank	Stop Screw	Wrench	Nut
22225F	CAT40 x ER16 - 2.76", hex nut	2.76"	1.08"	.406"	16083	04609	41116
22227F	CAT40 x ER16 - 4", hex nut	4"	1.08"	.406"	16083	04609	41116
22231F	CAT40 x ER16 - 6", hex nut	6"	1.08"	.406"	16083	04609	41116
22233F	CAT40 x ER16 - 8", hex nut	8"	1.08"	.406"	16083	04609	41116
22235F	CAT40 x ER20 - 2.76", hex nut	2.76"	1.34"	.512"	16087	04610	41120
22237F	CAT40 x ER20 - 4", hex nut	4"	1.34"	.512"	16087	04610	41120
22239F	CAT40 x ER20 - 6", hex nut	6"	1.34"	.512"	16087	04610	41120
22243F	CAT40 x ER25 - 2.76", slotted nut	2.76"	1.65"	.630"	16089	04615	41925
22245F	CAT40 x ER25 - 4", slotted nut	4"	1.65"	.630"	16089	04615	41925
22247F	CAT40 x ER25 - 6", slotted nut	6"	1.65"	.630"	16089	04615	41925
22251F	CAT40 x ER25 - 8", slotted nut	8"	1.65"	.630"	16089	04615	41925
22253F	CAT40 x ER32 - 2.76", slotted nut	2.76"	1.97"	.788"	16089	04616	41932
22255F	CAT40 x ER32 - 4", slotted nut	4"	1.97"	.788"	16089	04616	41932
22257F	CAT40 x ER32 - 6", slotted nut	6"	1.97"	.788"	16089	04616	41932
22259F	CAT40 x ER32 - 8", slotted nut	8"	1.97"	.788"	16089	04616	41932
22261F	CAT40 x ER40 - 3.15", slotted nut	3.15"	2.48"	1.023"	16091	04617	41940
22263F	CAT40 x ER40 - 4", slotted nut	4"	2.48"	1.023"	16091	04617	41940

Slot Nut Option: Add "-SLOTNUT" to part number for ER16 and 20 slotted nuts

Coolant Nut Option: Add "-C" to part number.

DNA Option: Add "-DNA" (ER16, ER20, & ER32)



# CAT40 ER COLLET CHUCKS - MINI NUT



pg. 44



pg. 62



pg. 64



pg. 229



pg. 236



pg. 238



## FEATURES

- Balanced to 25,000 RPM at G2.5
- Narrow nut diameter for better clearance
- PowerCOAT Nut increases holding power by 75%



Techniks Certified for accuracy and balance. Each holder comes with a complete lab report. PowerCOAT nut is included with each holder.

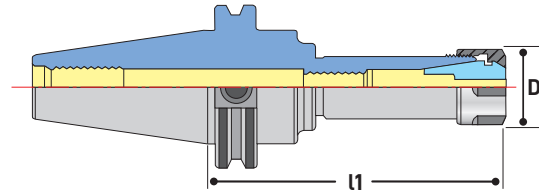

### TRY TECHNIKS DEAD NUTS ACCURATE DNA COLLETS & NUTS SYSTEM

For shank sizes 1/8" (3mm) or smaller use our DNA (dead nuts accurate) collets for improved results.

See page 48.





#### Coolant Options

- ER Coolant Rings (pg. 64)
- ER Steel Sealed Collets (pg. 50)
- ER Steel Sealed Collets with CoolBLAST (pg. 53)
- ER Coolant Collets (pg. 53)
- ER Mini Coolant Nuts (pg. 63)

## CAT40 ER COLLET CHUCKS **MINI NUT**

Coolant Stop Screws page 41.

Part No.	Description	l1	D	Max. Shank	Stop Screw	Wrench	Nut
22352	CAT40 x ER11 - 2.75", mini nut	2.75"	.63"	.275"	16081	04621	23111
22354	CAT40 x ER11 - 4", mini nut	4"	.63"	.275"	16081	04621	23111
22354-6	CAT40 x ER11 - 6", mini nut	6"	.63"	.275"	16081	04621	23111
22354-8.5	CAT40 x ER11 - 8.5", mini nut	8.5"	.63"	.275"	16081	04621	23111
22356	CAT40 x ER16 - 2.76", mini nut	2.76"	.87"	.406"	16083	04622	23116
22358	CAT40 x ER16 - 4", mini nut	4"	.87"	.406"	16083	04622	23116
22359	CAT40 x ER16 - 6", mini nut	6"	.87"	.406"	16083	04622	23116
22359-8	CAT40 x ER16 - 8", mini nut	8"	.87"	.406"	16083	04622	23116
22360	CAT40 x ER20 - 2.76", mini nut	2.76"	1.102"	.512"	16087	04623	23120
22362	CAT40 x ER20 - 4", mini nut	4"	1.102"	.512"	16087	04623	23120

Coolant Nut Option: Add "-C" to part number.



 Techniks Certified for accuracy and balance. Each holder comes with a complete lab report. PowerCOAT nut is included with each holder.

## FEATURES

- Balanced to 25,000 RPM at G2.5
- Best T.I.R. and shortest projection of any collet chuck
- SuperRIGID for high torque or high speed machining

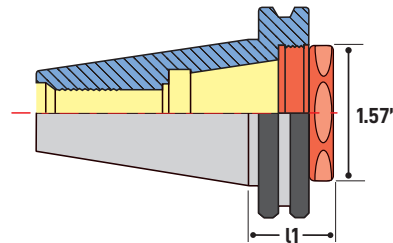

PowerCOAT  
TE-22HN Nut

## CAT40 ER COLLET CHUCKS **SUPER RIGID**

Part No.	Description	l1	Collet	Max. Shank	Wrench
22253S	CAT40 x ER32	1.10"	ER32	3/4" or 20mm	894-36
TE-22HN	hex style PowerCOAT replacement nut				

\* Thru-spindle coolant capable.

\* Compatible with sealed, tap, and standard collets.

### TECHNIKS SUPER RIGID HOLDERS

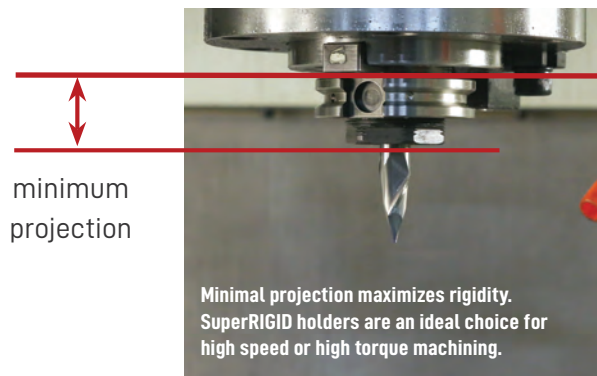

### STANDARD HOLDERS

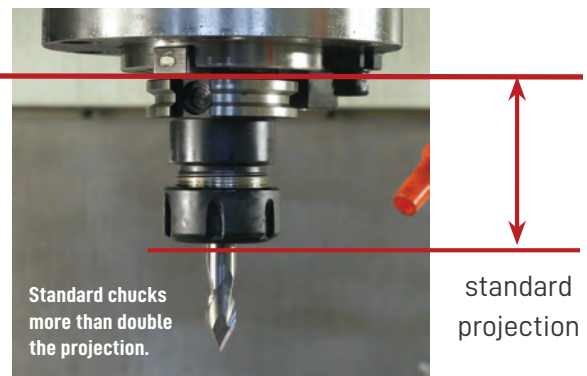

Minimum projection = increased rigidity, better T.I.R. and extended tool life.



# CAT40 ER COLLET CHUCKS - DUALDRIVE



pg. 44



pg. 62



pg. 64



pg. 229



pg. 236



pg. 238



Techniks Certified for accuracy and balance. Each holder comes with a complete lab report. PowerCOAT nut is included with each holder.

## FEATURES

- DualDRIVE for dual-contact spindles increases rigidity and accuracy during machining
- Improved performance at high metal removal rates and when machining at extended lengths
- Through spindle and AD+B coolant enabled

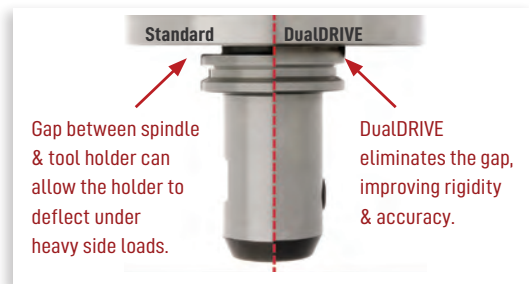
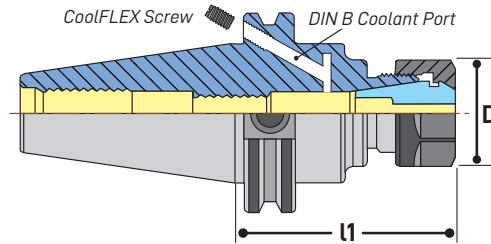

## COOLFLEX FEATURE

CoolFLEX holders are factory set for coolant-thru spindle. Remove the stop screws for DIN B coolant-thru flange.

Part No.	Description
HSA-4-6	40 taper DIN B screw

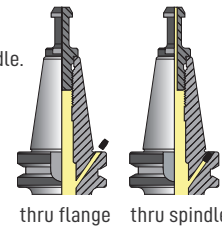

## CAT40 ER COLLET CHUCKS **DUALDRIVE**

Coolant Stop Screws page 41.

Part No.	Description	l1	D	Max. Shank	Stop Screw	Wrench	Nut
46.122.16.276	SCAT40 x ER16 - 2.76" DualDRIVE, hex nut	2.76"	1.08"	.406"	16083	04609	41116
46.122.16.400	SCAT40 x ER16 - 4" DualDRIVE, hex nut	4"	1.08"	.406"	16083	04609	41116
46.122.16.600	SCAT40 x ER16 - 6" DualDRIVE, hex nut	6"	1.08"	.406"	16083	04609	41116
46.122.16.800	SCAT40 x ER16 - 8" DualDRIVE, hex nut	8"	1.08"	.406"	16083	04609	41116
46.122.20.276	SCAT40 x ER20 - 2.76" DualDRIVE, hex nut	2.76"	1.34"	.512"	16087	04610	41120
46.122.20.400	SCAT40 x ER20 - 4" DualDRIVE, hex nut	4"	1.34"	.512"	16087	04610	41120
46.122.20.600	SCAT40 x ER20 - 6" DualDRIVE, hex nut	6"	1.34"	.512"	16087	04610	41120
46.122.20.800	SCAT40 x ER20 - 8" DualDRIVE, hex nut	8"	1.34"	.512"	16087	04610	41120
46.122.32.276	SCAT40 x ER32 - 2.76" DualDRIVE, slotted nut	2.76"	1.97"	.788"	16089	04616	41932
46.122.32.400	SCAT40 x ER32 - 4" DualDRIVE, slotted nut	4"	1.97"	.788"	16089	04616	41932
46.122.32.600	SCAT40 x ER32 - 6" DualDRIVE, slotted nut	6"	1.97"	.788"	16089	04616	41932
46.122.32.800	SCAT40 x ER32 - 8" DualDRIVE, slotted nut	8"	1.97"	.788"	16089	04616	41932
46.122.40.315	SCAT40 x ER40 - 3.15" DualDRIVE, slotted nut	3.15"	2.48"	1.023"	16091	04617	41940
46.122.40.600	SCAT40 x ER40 - 6" DualDRIVE, slotted nut	6"	2.48"	1.023"	16091	04617	41940
46.122.40.800	SCAT40 x ER40 - 8" DualDRIVE, slotted nut	8"	2.48"	1.023"	16091	04617	41940

**Slot Nut Option:** Add "-SLOTNUT" to part number for ER16 and 20 slotted nuts

**Coolant Nut Option:** Add "-C" to part number.

**DNA Option:** Add "-DNA" (ER16, ER20, & ER32)



pg. 44



pg. 62



pg. 64



pg. 229



pg. 236



pg. 238

# CAT50 ER COLLET CHUCKS



## FEATURES

- Balanced to 25,000 RPM at G2.5
- Maximum 0.0001" T.I.R. measured from taper to collet pocket
- PowerCOAT Nut increases holding power by 75%

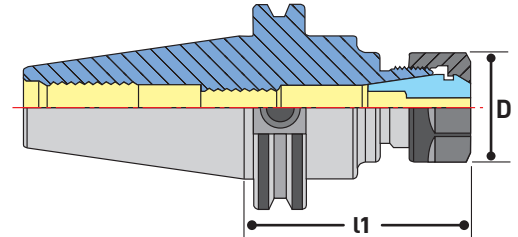

## CAT50 ER COLLET CHUCKS

Part No.	Description	L1	D	Max. Shank	Stop Screw	Wrench	Nuts
22281	CAT50 x ER16 - 4", hex nut	4"	1.08"	.406"	16083	04609	41116
22285	CAT50 x ER16 - 6", hex nut	6"	1.08"	.406"	16083	04609	41116
22287	CAT50 x ER16 - 8", hex nut	8"	1.08"	.406"	16083	04609	41116
22287-10T	CAT50 x ER16 - 10", hex nut	10"	1.08"	.406"	16083	04609	41116
22287-12T	CAT50 x ER16 - 12", hex nut	12"	1.08"	.406"	16083	04609	41116
22291	CAT50 x ER20 - 4", hex nut	4"	1.34"	.512"	16087	04610	41120
22293	CAT50 x ER20 - 6", hex nut	6"	1.34"	.512"	16087	04610	41120
22295	CAT50 x ER20 - 8", hex nut	8"	1.34"	.512"	16087	04610	41120
22295-10T	CAT50 x ER20 - 10", hex nut	10"	1.34"	.512"	16087	04610	41120
22295-12T	CAT50 x ER20 - 12", hex nut	12"	1.34"	.512"	16087	04610	41120
22303	CAT50 x ER25 - 4", slotted nut	4"	1.65"	.630"	16089	04615	41925
22305	CAT50 x ER25 - 6", slotted nut	6"	1.65"	.630"	16089	04615	41925
22307	CAT50 x ER25 - 8", slotted nut	8"	1.65"	.630"	16089	04615	41925
22307-9	CAT50 x ER25 - 9", slotted nut	9"	1.65"	.630"	16089	04615	41925
22311	CAT50 x ER32 - 4", slotted nut	4"	1.97"	.788"	16089	04616	41932
22313	CAT50 x ER32 - 6", slotted nut	6"	1.97"	.788"	16089	04616	41932
22317	CAT50 x ER32 - 8", slotted nut	8"	1.97"	.788"	16089	04616	41932
22317-10T	CAT50 x ER32 - 10", slotted nut	10"	1.97"	.788"	16089	04616	41932
22317-12T	CAT50 x ER32 - 12", slotted nut	12"	1.97"	.788"	16089	04616	41932
22321	CAT50 x ER40 - 4", slotted nut	4"	2.48"	1.023"	16091	04617	41940
22325	CAT50 x ER40 - 6", slotted nut	6"	2.48"	1.023"	16091	04617	41940
22327	CAT50 x ER40 - 8", slotted nut	8"	2.48"	1.023"	16091	04617	41940
22327-10T	CAT50 x ER40 - 10", slotted nut	10"	2.48"	1.023"	16091	04617	41940
22331	CAT50 x ER50 - 4", slotted nut	4"	3.07"	1.338"	16093	04618	41950
22335	CAT50 x ER50 - 6", slotted nut	6"	3.07"	1.338"	16093	04618	41950
22337	CAT50 x ER50 - 8", slotted nut	8"	3.07"	1.338"	16093	04618	41950

**Slot Nut Option:** Add "-SLOTNUT" to part number for ER16 and 20 slotted nuts

**Coolant Nut Option:** Add "-C" to part number. Coolant nuts are not available for ER50.

**DNA Option:** Add "-DNA" (ER16, ER20, & ER32)



# CAT50 ER COLLET CHUCKS - COOLFLEX



pg. 44



pg. 62



pg. 64



pg. 229



pg. 236



pg. 238

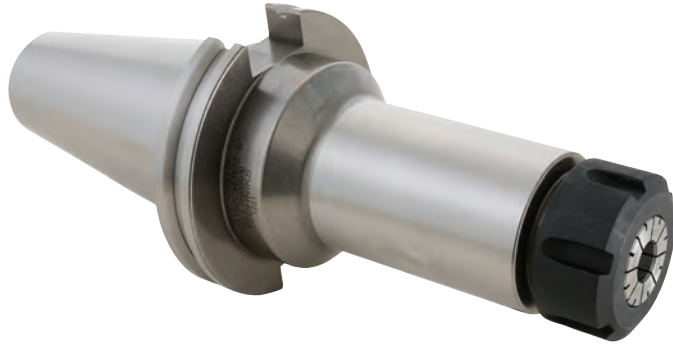

## FEATURES

- Balanced to 25,000 RPM at G2.5
- Maximum 0.0001" T.I.R. measured from taper to collet pocket
- PowerCOAT Nut increases holding power by 75%



Techniks Certified for accuracy and balance. Each holder comes with a complete lab report. PowerCOAT nut is included with each holder.

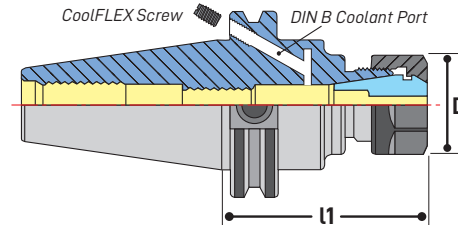

### TRY TECHNIKS DEAD NUTS ACCURATE DNA COLLETS & NUTS SYSTEM

For shank sizes 1/8" (3mm) or smaller use our DNA (dead nuts accurate) collets for improved results.

See page 48.

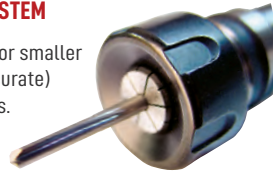

### COOLFLEX FEATURE

CoolFLEX holders are factory set for coolant-thru spindle. Remove the stop screws for DIN B coolant-thru flange.

Part No.	Description
HSA-6-6	50 taper DIN B screw

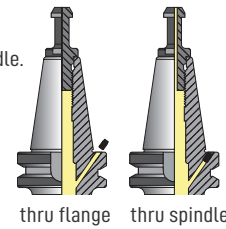

## CAT50 ER COLLET CHUCKS COOLFLEX

Part No.	Description	l1	D	Max. Shank	Stop Screw	Wrench	Nut
22281F	CAT50 x ER16 - 4", hex nut	4"	1.08"	.406"	16083	04609	41116
22285F	CAT50 x ER16 - 6", hex nut	6"	1.08"	.406"	16083	04609	41116
22291F	CAT50 x ER20 - 4", hex nut	4"	1.34"	.512"	16087	04610	41120
22293F	CAT50 x ER20 - 6", hex nut	6"	1.34"	.512"	16087	04610	41120
22295F	CAT50 x ER20 - 8", hex nut	8"	1.34"	.512"	16087	04610	41120
22303F	CAT50 x ER25 - 4", slotted nut	4"	1.65"	.630"	16089	04615	41925
22311F	CAT50 x ER32 - 4", slotted nut	4"	1.97"	.788"	16089	04616	41932
22313F	CAT50 x ER32 - 6", slotted nut	6"	1.97"	.788"	16089	04616	41932
22317F	CAT50 x ER32 - 8", slotted nut	8"	1.97"	.788"	16089	04616	41932
22321F	CAT50 x ER40 - 4", slotted nut	4"	2.48"	1.023"	16091	04617	41940
22327F	CAT50 x ER40 - 8", slotted nut	8"	2.48"	1.023"	16091	04617	41940

**Slot Nut Option:** Add "-SLOTNUT" to part number for ER16 and 20 slotted nuts

**Coolant Nut Option:** Add "-C" to part number.

**DNA Option:** Add "-DNA" (ER16, ER20, & ER32)





## FEATURES

- Balanced to 25,000 RPM at G2.5
- Narrow nut diameter for better clearance
- PowerCOAT Nut increases holding power by 75%

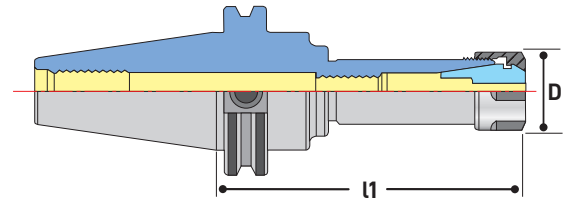
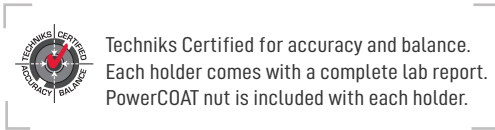

### TRY TECHNIKS DEAD NUTS ACCURATE DNA COLLETS & NUTS SYSTEM

For shank sizes 1/8" (3mm) or smaller use our DNA (dead nuts accurate) collets for improved results.

See page 48.

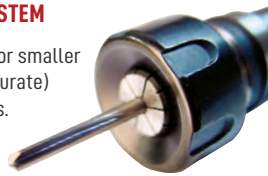



#### Coolant Options

- ER Coolant Rings (pg. 64)
- ER Steel Sealed Collets (pg. 50)
- ER Steel Sealed Collets with CoolBLAST (pg. 52)
- ER Coolant Collets (pg. 53)
- ER Mini Coolant Nuts (pg. 63)

## CAT50 ER COLLET CHUCKS **MINI NUT**

Coolant Stop Screws page 41.

Part No.	Description	l1	D	Max. Shank	Stop Screw	Wrench	Nut
22364	CAT50 x ER16 - 4", mini nut	4"	.87"	.406"	16083	04622	23116
22366	CAT50 x ER16 - 6", mini nut	6"	.87"	.406"	16083	04622	23116
22368	CAT50 x ER20 - 4", mini nut	4"	1.102"	.512"	16087	04623	23120
22370	CAT50 x ER20 - 6", mini nut	6"	1.102"	.512"	16087	04623	23120

**Coolant Nut Option:** Add "-C" to part number.

# CAT50 ER COLLET CHUCKS - SUPER RIGID



## FEATURES

- Balanced to 25,000 RPM at G2.5
- Best T.I.R. and shortest projection of any collet chuck
- SuperRIGID for high torque or high speed machining



Techniks Certified for accuracy and balance. Each holder comes with a complete lab report. PowerCOAT nut is included with each holder.

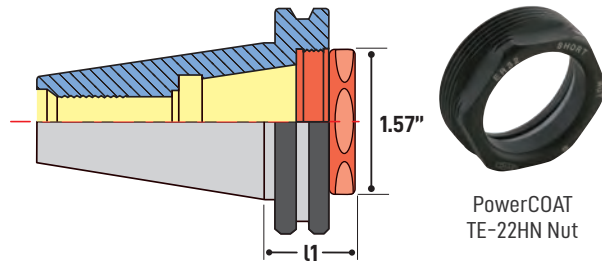

## CAT50 ER COLLET CHUCKS SUPER RIGID

Part No.	Description	l1	Collet	Max. Shank	Wrench
22311S	CAT50 x ER32	1.10"	ER32	3/4" or 20mm	894-36
TE-22HN	hex style PowerCOAT nut				

\* Thru-spindle coolant capable.

\* Compatible with sealed, tap, and standard collets.

### TECHNIKS SUPER RIGID HOLDERS

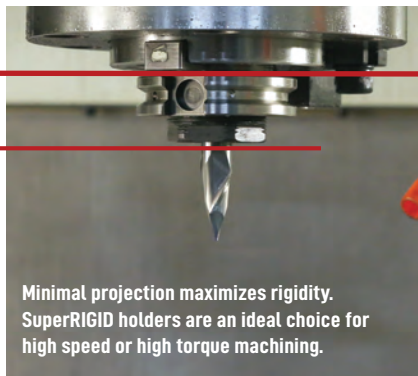

### STANDARD HOLDERS

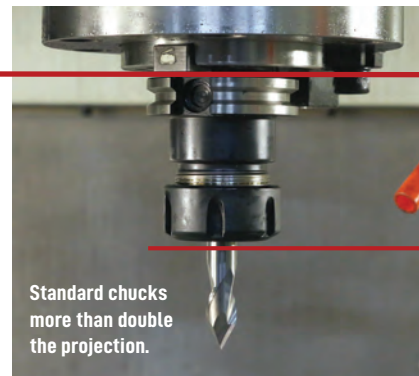

Minimum projection = increased rigidity, better T.I.R. and extended tool life.



 Techniks Certified for accuracy and balance. Each holder comes with a complete lab report. PowerCOAT nut is included with each holder.

## FEATURES

- DualDRIVE for dual-contact spindles increases rigidity and accuracy during machining
- Improved performance at high metal removal rates and when machining at extended lengths
- Through spindle and AD+B coolant enabled

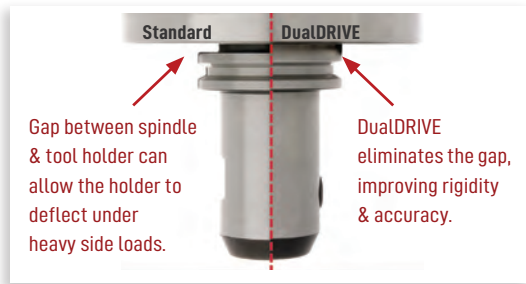
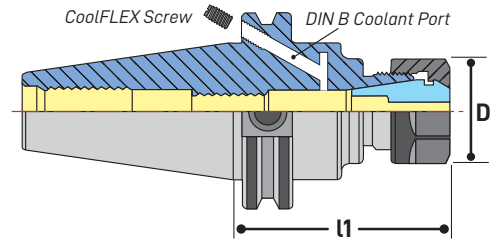

## COOLFLEX FEATURE

CoolFLEX holders are factory set for coolant-thru spindle. Remove the stop screws for DIN B coolant-thru flange.

Part No.	Description
HSA-6-6	50 taper DIN B screw

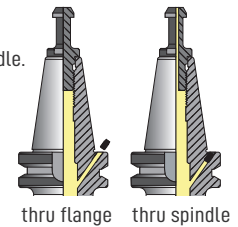

## CAT50 ER COLLET CHUCKS **DUALDRIVE**

Coolant Stop Screws page 41.

Part No.	Description	l1	D	Max. Shank	Stop Screw	Wrench	Nut
47.122.16.400	SCAT50 x ER16 - 4" DualDRIVE	4"	1.08"	.406"	16083	04609	41116
47.122.16.600	SCAT50 x ER16 - 6" DualDRIVE	6"	1.08"	.406"	16083	04609	41116
47.122.16.800	SCAT50 x ER16 - 8" DualDRIVE	8"	1.08"	.406"	16083	04609	41116
47.122.20.400	SCAT50 x ER20 - 4" DualDRIVE	4"	1.34"	.512"	16087	04610	41120
47.122.20.600	SCAT50 x ER20 - 6" DualDRIVE	6"	1.34"	.512"	16087	04610	41120
47.122.20.800	SCAT50 x ER20 - 8" DualDRIVE	8"	1.34"	.512"	16087	04610	41120
47.122.32.400	SCAT50 x ER32 - 4" DualDRIVE	4"	1.97"	.788"	16089	04616	41932
47.122.32.600	SCAT50 x ER32 - 6" DualDRIVE	6"	1.97"	.788"	16089	04616	41932
47.122.32.800	SCAT50 x ER32 - 8" DualDRIVE	8"	1.97"	.788"	16089	04616	41932
47.122.40.400	SCAT50 x ER40 - 4" DualDRIVE	4"	2.48"	1.023"	16091	04617	41940
47.122.40.600	SCAT50 x ER40 - 6" DualDRIVE	6"	2.48"	1.023"	16091	04617	41940
47.122.40.800	SCAT50 x ER40 - 8" DualDRIVE	8"	2.48"	1.023"	16091	04617	41940

Slot Nut Option: Add "-SLOTNUT" to part number for ER16 and 20 slotted nuts

Coolant Nut Option: Add "-C" to part number.

DNA Option: Add "-DNA" (ER16, ER20, & ER32)



# BT30 ER COLLET CHUCKS



pg. 44



pg. 62



pg. 64



pg. 229



pg. 236



pg. 238

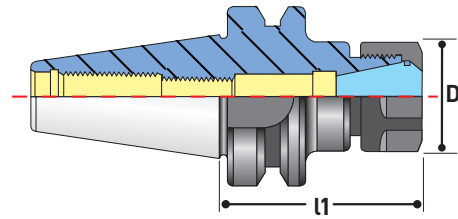

## BT30 ER COLLET CHUCKS

Part No.	Description	l1	D	Max. Shank	Stop Screw	Wrench	Nut
16102	BT30 x ER16 - 60mm, hex nut	60mm	1.08"	.406"	16083	04609	41116
16101	BT30 x ER16 - 70mm, hex nut	70mm	1.08"	.406"	16083	04609	41116
16103	BT30 x ER16 - 90mm, hex nut	90mm	1.08"	.406"	16083	04609	41116
16104	BT30 x ER16 - 100mm, hex nut	100mm	1.08"	.406"	16083	04609	41116
16105	BT30 x ER16 - 120mm, hex nut	120mm	1.08"	.406"	16083	04609	41116
16106	BT30 x ER20 - 70mm, hex nut	70mm	1.34"	.512"	16087	04610	41120
16107	BT30 x ER20 - 135mm, hex nut	135mm	1.34"	.512"	16087	04610	41120
16108-2.5	BT30 x ER20 - 63.5mm, hex nut	63.5mm	1.34"	.512"	16087	04610	41120
16109	BT30 x ER25 - 70mm, slotted nut	70mm	1.65"	.630"	16089	04615	41925
16110	BT30 x ER25 - 60mm, slotted nut	60mm	1.65"	.630"	16089	04615	41925
16111-90	BT30 x ER25 - 90mm, slotted nut	90mm	1.65"	.630"	16089	04615	41925
16111	BT30 x ER25 - 135mm, slotted nut	135mm	1.65"	.630"	16089	04615	41925
16112	BT30 x ER32 - 60mm, slotted nut	60mm	1.97"	.788"	16089	04616	41932
16113	BT30 x ER32 - 70mm, slotted nut	70mm	1.97"	.788"	16089	04616	41932
16114	BT30 x ER32 - 100mm, slotted nut	100mm	1.97"	.788"	16089	04616	41932
16115	BT30 x ER40 - 80mm, slotted nut	80mm	2.48"	1.023"	16089	04617	41940

**Slot Nut Option:** Add "-SLOTNUT" to part number for ER16 and 20 slotted nuts

**Coolant Nut Option:** Add "-C" to part number.

**DNA Option:** Add "-DNA" (ER16, ER20, & ER32)

## BT30 ER COLLET CHUCKS NO FLATS

Part No.	Description	l1	D	Stop Screw	Wrench	Nut
16106-W	BT30 x ER20 - 70 without drive slots	70mm	34mm	16087	04614	46120
16121	BT30 x ER32 - 60, 41mm no flats - Komo	60mm	50mm	16089	04616	46132
16131	BT30 x ER32 - 90 38mm no flats - Komo	90mm	50mm	16089	04616	46132

## BT30 SYOZ 25 ER COLLET CHUCKS

Part No.	Description	l1	D	Wrench	Nut
16001-W	BT30 x SYOZ 25 - 70, 38mm flats	70mm	60mm	83691	83632
16001	BT30 x SYOZ 25 - 70 with nut	70mm	60mm	83691	83632

## BT35 ER COLLET CHUCKS

Part No.	Description	l1	D	Wrench	Nut
16010	BT 35 x SYOZ 25 - 76	76mm	60mm	83691	83632
161-BT35-ER32 76	BT 35 x ER32 - 76	76mm	50mm	04616	46132

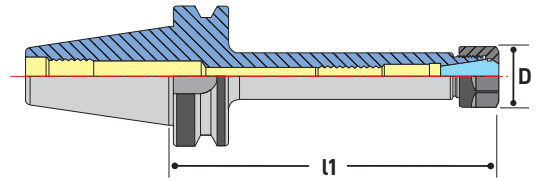

## BT30 ER COLLET CHUCKS **DUALDRIVE**

Part No.	Description	l1	D	Max. Shank	Stop Screw	Wrench	Nut
25.122.16.060	SBT30 x ER16 - 60mm DualDRIVE	60mm	27.43mm	.406"	16083	04609	41116
25.122.16.060-C	SBT30 x ER16 - 60mm DualDRIVE w/ Coolant Nut	60mm	32mm	.406"	16083	04613	41116
25.122.16.060-SLOTNUT	SBT30 x ER16 - 60mm DualDRIVE w/ Slotted Nut	60mm	32mm	.406"	16083	04613	41116
25.122.16.090	SBT30 x ER16 - 90mm DualDRIVE	90mm	27.43mm	.406"	16083	04609	41116
25.122.16.090-C	SBT30 x ER16 - 90mm DualDRIVE w/ Coolant Nut	90mm	32mm	.406"	16083	04613	4116
25.122.16.090-SLOTNUT	SBT30 x ER16 - 90mm DualDRIVE w/ Slotted Nut	90mm	32mm	.406"	16083	04613	4116
25.122.16.105	SBT30 x ER16 - 105mm DualDRIVE	105mm	27.43mm	.406"	16083	04609	41116
25.122.16-105-C	SBT30 x ER16 - 105mm DualDRIVE w/ Coolant Nut	105mm	32mm	.406"	16083	04613	41116
25.122.20.105	SBT30 x ER20 - 105mm DualDRIVE	105mm	34.04mm	.512"	16087	04610	41120
25.122.20.060	SBT30 x ER20 - 60mm DualDRIVE	60mm	34.04mm	.512"	16087	04610	41120
25.122.20.060-SLOTNUT	SBT30 x ER20 - 60mm DualDRIVE w/ Slotted Nut	60mm	35mm	.512"	16087	04614	41120
25.122.20.090	SBT30 x ER20 - 90mm DualDRIVE	90mm	34.04mm	.512"	16087	04610	41120
25.122.20.090-SLOTNUT	SBT30 x ER20 - 90mm DualDRIVE w/ Slotted Nut	90mm	35mm	.512"	16087	04614	41120
25.122.25.060	SBT30 x ER25 - 60mm DualDRIVE	60mm	41.91mm	.630"	16089	04615	41925
25.122.32.060	SBT30 x ER32 - 60mm DualDRIVE	60mm	50.04mm	.788"	16089	04616	41925
25.122.32.060-C	SBT30 x ER32 - 60mm DualDRIVE w/ Coolant Nut	60mm	50mm	.788"	16089	04616	41925
25.122.32.090	SBT30 x ER32 - 90mm DualDRIVE	90mm	50.04mm	.788"	16089	04616	41925
25.122.32.090-C	SBT30 x ER32 - 90mm DualDRIVE w/ Coolant Nut	90mm	50mm	.788"	16089	04616	41925
25.122.40.080	SBT30 x ER40 - 80mm DualDRIVE	80mm	62.99mm	1.023"	16091	04617	41940

**Slot Nut Option:** Add "-SLOTNUT" to part number for ER16 and 20 slotted nuts

**Coolant Nut Option:** Add "-C" to part number.

**DNA Option:** Add "-DNA" (ER16, ER20, & ER32)

## BT30 ER COLLET CHUCKS **MINI NUT**

Part No.	Description	l1	D	Max. Shank	Stop Screw	Wrench	Nut
16302	BT30 x ER11 - 70mm, mini nut	70	.63"	.275"	16081	04621	23111
16304	BT30 x ER11 - 100mm, mini nut	100mm	.63"	.275"	16081	04621	23111
16308	BT30 x ER16 - 70mm, mini nut	70mm	.87"	.406"	16083	04622	23116
16312	BT30 x ER16 - 120mm, mini nut	120mm	.87"	.406"	16083	04622	23116
16313	BT30 x ER20 - 70mm, mini nut	70mm	1.102"	.512"	16087	04623	23120
16314	BT30 x ER20 - 100mm, mini nut	100mm	1.102"	.512"	16087	04623	23120
16318	BT30 x ER20 - 150mm, mini nut	150mm	1.102"	.512"	16087	04623	23120

**Coolant Nut Option:** Add "-C" to part number.

# BT40 ER COLLET CHUCKS



pg. 44



pg. 62



pg. 64



pg. 229



pg. 236



pg. 238

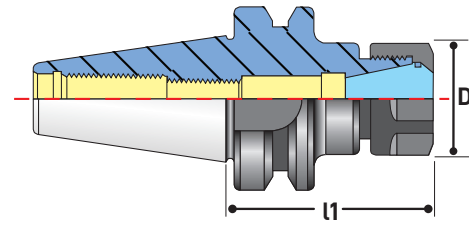

## BT40 ER COLLET CHUCKS

Part No.	Description	l1	D	Max. Shank	Stop Screw	Wrench	Nut
16151	BT40 x ER16 - 70mm, hex nut	70mm	1.08"	.406"	16083	04609	41116
16153	BT40 x ER16 - 100mm, hex nut	100mm	1.08"	.406"	16083	04609	41116
16155	BT40 x ER16 - 125mm, hex nut	125mm	1.08"	.406"	16083	04609	41116
16157	BT40 x ER16 - 150mm, hex nut	150mm	1.08"	.406"	16083	04609	41116
16158	BT40 x ER16 - 180mm, hex nut	180mm	1.08"	.406"	16083	04609	41116
16159	BT40 x ER20 - 70mm, hex nut	70mm	1.34"	.512"	16085	04610	41120
16162	BT40 x ER20 - 100mm, hex nut	100mm	1.34"	.512"	16085	04610	41120
16165	BT40 x ER20 - 135mm, hex nut	135mm	1.34"	.512"	16085	04610	41120
16167	BT40 x ER20 - 150mm, hex nut	150mm	1.34"	.512"	16085	04610	41120
16169	BT40 x ER25 - 70mm, slotted nut	70mm	1.65"	.630"	16089	04615	41925
16171	BT40 x ER25 - 100mm, slotted nut	100mm	1.65"	.630"	16089	04615	41925
16175	BT40 x ER25 - 150mm, slotted nut	150mm	1.65"	.630"	16089	04615	41925
16177	BT40 x ER32 - 70mm, slotted nut	70mm	1.97"	.788"	16089	04616	41932
16179	BT40 x ER32 - 100mm, slotted nut	100mm	1.97"	.788"	16089	04616	41932
16181	BT40 x ER32 - 150mm, slotted nut	150mm	1.97"	.788"	16089	04616	41932
16183	BT40 x ER40 - 80mm, slotted nut	80mm	2.48"	1.023"	16089	04617	41940
16185	BT40 x ER40 - 100mm, slotted nut	100mm	2.48"	1.023"	16089	04617	41940
16189	BT40 x ER40 - 150mm, slotted nut	150mm	2.48"	1.023"	16089	04617	41940

**Slot Nut Option:** Add "-SLOTNUT" to part number for ER16 and 20 slotted nuts

**Coolant Nut Option:** Add "-C" to part number.

**DNA Option:** Add "-DNA" (ER16, ER20, & ER32)

## BT40 ER COLLET CHUCKS **DUALDRIVE**

Part No.	Description	l1	D	Max. Shank	Stop Screw	Wrench	Nut
28.122.25.100	SBT 40 x ER 25 - 100mm DualDRIVE, slotted nut	100mm	1.65"	.630"	16089	04615	04615
28.122.32.200	SBT 40 X ER 32 - 200mm DualDRIVE, slotted nut	200mm	1.97"	.788"	16089	04616	04616
26.123.16.070	SBT 40 x ER 16M - 70mm DualDRIVE, mini nut	70mm	.63"	.275"	16083	04622	04622
26.123.16.150	SBT 40 x ER 16M - 150mm DualDRIVE, mini nut	150mm	.63"	.275"	16083	04622	04622
26.122.32.070	SBT 40 x ER 32 - 70mm DualDRIVE	70mm	1.97"	.788"	16089	04616	04616
26.122.32.100	SBT 40 x ER 32 - 100mm DualDRIVE	100mm	1.97"	.788"	16089	04616	04616
26.122.32.150	SBT 40 x ER 32 - 150mm DualDRIVE	150mm	1.97"	.788"	16089	04616	04616

**Coolant Nut Option:** Add "-C" to part number.







 Techniks Certified for accuracy and balance. Each holder comes with a complete lab report. PowerCOAT nut is included with each holder.

## FEATURES

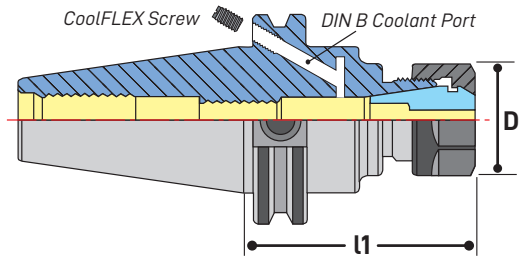
- Balanced to 25,000 RPM at G2.5
- Maximum 0.0001" T.I.R. measured from taper to collet pocket
- Coolant-thru spindle or thru flange (DIN B)



### TRY TECHNIKS DEAD NUTS ACCURATE DNA COLLETS & NUTS SYSTEM

For shank sizes 1/8" (3mm) or smaller use our DNA (Dead Nuts Accurate) collets for improved results.

See page 48.

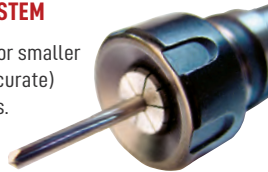

### COOLFLEX FEATURE

CoolFLEX holders are factory set for coolant-thru spindle. Remove the stop screws for DIN B coolant-thru flange.

Part No.	Description
HSA-4-6	40 taper DIN B screw

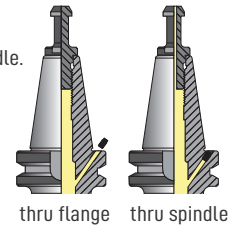

## BT40 ER COLLET CHUCKS **COOLFLEX**

Coolant Stop Screws page 41.

Part No.	Description	l1	D	Max. Shank	Stop Screw	Wrench	Nut
16151F	BT40 x ER16 - 70mm, hex nut, CoolFLEX	70mm	1.08"	.406"	16083	04609	41116
16153F	BT40 x ER16 - 100mm, hex nut, CoolFLEX	100mm	1.08"	.406"	16083	04609	41116
16157F	BT40 x ER16 - 150mm, hex nut, CoolFLEX	150mm	1.08"	.406"	16083	04609	41116
16159F	BT40 x ER20 - 70mm, hex nut, CoolFLEX	70mm	1.34"	.512"	16085	04610	41120
16162F	BT40 x ER20 - 100mm, hex nut, CoolFLEX	100mm	1.34"	.512"	16085	04610	41120
16167F	BT40 x ER20 - 150mm, hex nut, CoolFLEX	150mm	1.34"	.512"	16085	04610	41120
16177F	BT40 x ER32 - 70mm, slotted, CoolFLEX	70mm	1.97"	.788"	16089	04616	41932
16181F	BT40 x ER32 - 150mm, slotted, CoolFLEX	150mm	1.97"	.788"	16089	04616	41932

**Slot Nut Option:** Add "-SLOTNUT" to part number for ER16 and 20 slotted nuts

**Coolant Nut Option:** Add "-C" to part number.

**DNA Option:** Add "-DNA" (ER16, ER20, & ER32)

# BT40 ER COLLET CHUCKS - MINI NUT



pg. 44



pg. 62



pg. 64



pg. 229



pg. 236



pg. 238



## FEATURES

- Balanced to 25,000 RPM at G2.5
- Maximum 0.0001" T.I.R. measured from taper to collet pocket
- Narrow nut diameter for better clearance

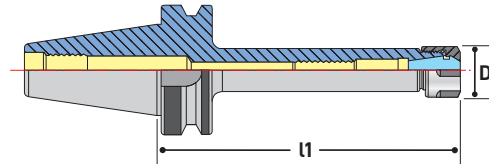

Techniks Certified for accuracy and balance. Each holder comes with a complete lab report. PowerCOAT nut is included with each holder.

### TRY TECHNIKS DEAD NUTS ACCURATE DNA COLLETS & NUTS SYSTEM

For shank sizes 1/8" (3mm) or smaller use our DNA (dead nuts accurate) collets for improved results.

See page 48.



### Coolant Options

- ER Coolant Rings (pg. 64)
- ER Steel Sealed Collets (pg. 50)
- ER Steel Sealed Collets with CoolBLAST (pg. 52)
- ER Coolant Collets (pg. 53)
- ER Mini Coolant Nuts (pg. 63)

## BT40 ER COLLET CHUCKS **MINI NUT**

Coolant Stop Screws page 41.

Part No.	Description	l1	D	Max. Shank	Stop Screw	Wrench	Nut
16321	BT40 x ER11 - 70mm, mini nut	70mm	16mm	.275"	16081	04621	23111
16324	BT40 x ER11 - 150mm, mini nut	150mm	16mm	.275"	16081	04621	23111
16325	BT40 x ER16 - 70mm, mini nut	70mm	22mm	.406"	16083	04622	23116
16328	BT40 x ER16 - 150mm, mini nut	150mm	22mm	.406"	16083	04622	23116
16328-200	BT40 x ER16 - 200mm, mini nut	200mm	22mm	.406"	16083	04622	23116
16329	BT40 x ER20 - 70mm, mini nut	70mm	28mm	.512"	16087	04623	23120
16330	BT40 x ER20 - 100mm, mini nut	100mm	28mm	.512"	16087	04623	23120
16332	BT40 x ER20 - 150mm, mini nut	150mm	28mm	.512"	16087	04623	23120

Coolant Nut Option: Add "-C" to part number.



 Techniks Certified for accuracy and balance. Each holder comes with a complete lab report. PowerCOAT nut is included with each holder.

## FEATURES

- Balanced to 25,000 RPM at G2.5
- Best T.I.R. and shortest projection of any collet chuck
- SuperRIGID for high torque or high speed machining

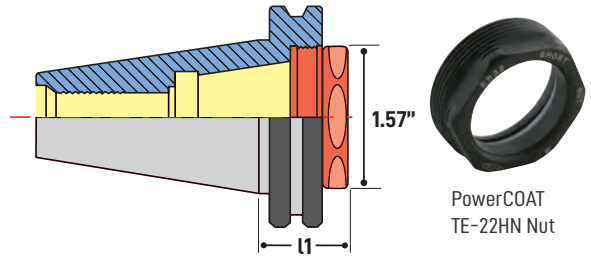

## BT40 ER COLLET CHUCKS **SUPER RIGID**

Part No.	Description	l1	Collet	Max. Shank	Wrench
16177S	BT40 x ER32	36mm	ER32	3/4" or 20mm	894-36
TE-22HN	hex style PowerCOAT nut				

\* Thru-spindle coolant capable.

\* Compatible with sealed, tap, and standard collets.

### TECHNIKS SUPER RIGID HOLDERS

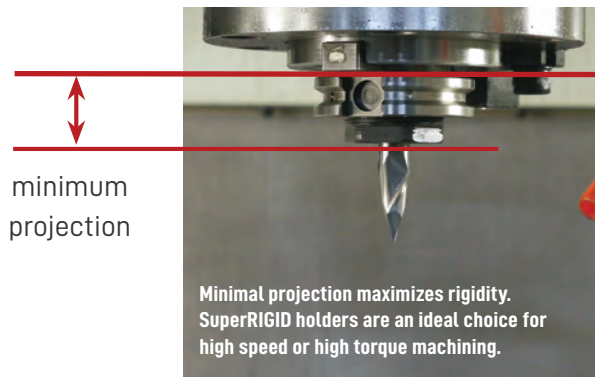

### STANDARD HOLDERS

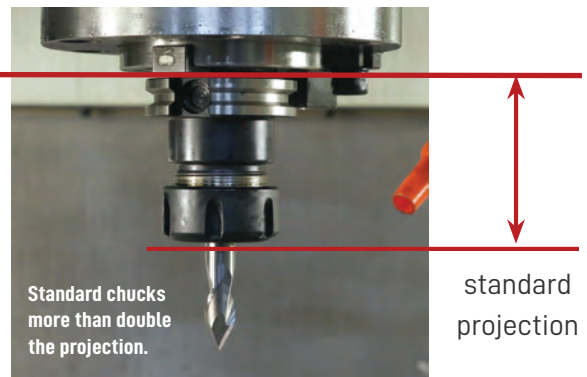

Minimum projection = increased rigidity, better T.I.R. and extended tool life.



# BT50 ER COLLET CHUCKS



pg. 44



pg. 62



pg. 64



pg. 229



pg. 236



pg. 238



Techniks Certified for accuracy and balance. Each holder comes with a complete lab report. PowerCOAT nut is included with each holder.

## FEATURES

- Balanced to 25,000 RPM at G2.5
- Maximum 0.0001" T.I.R. measured from taper to collet pocket
- PowerCOAT Nut increases holding power by 75%

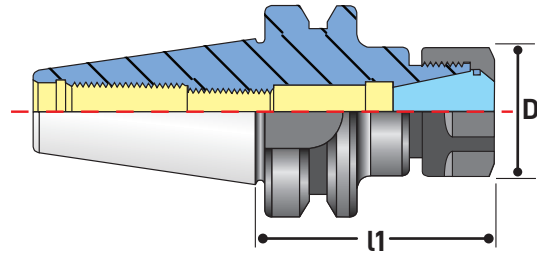

## BT50 ER COLLET CHUCKS

Coolant Stop Screws page 41.

Part No.	Description	l1	D	Max. Shank	Stop Screw	Wrench	Nut
16251	BT50 x ER16 - 70mm, hex nut	70mm	1.08"	.406"	16083	04609	41116
16252	BT50 x ER16 - 90mm, hex nut	90mm	1.08"	.406"	16083	04609	41116
16253	BT50 x ER16 - 105mm, hex nut	105mm	1.08"	.406"	16083	04609	41116
16254	BT50 x ER16 - 135mm, hex nut	135mm	1.08"	.406"	16083	04609	41116
16255	BT50 x ER16 - 150mm, hex nut	150mm	1.08"	.406"	16083	04609	41116
16263	BT50 x ER20 - 90mm, hex nut	90mm	1.34"	.512"	16087	04610	41120
16265	BT50 x ER20 - 105mm, hex nut	105mm	1.34"	.512"	16087	04610	41120
16267	BT50 x ER20 - 135mm, hex nut	135mm	1.34"	.512"	16087	04610	41120
16271	BT50 x ER20 - 165mm, hex nut	165mm	1.34"	.512"	16087	04610	41120
16275	BT50 x ER25 - 105mm, slotted nut	105mm	1.65"	.630"	16089	04615	41925
16277	BT50 x ER25 - 135mm, slotted nut	135mm	1.65"	.630"	16089	04615	41925
16279	BT50 x ER25 - 165mm, slotted nut	165mm	1.65"	.630"	16089	04615	41925
16281	BT50 x ER32 - 80mm, slotted nut	80mm	1.97"	.788"	16089	04616	41932
16283	BT50 x ER32 - 120mm, slotted nut	120mm	1.97"	.788"	16089	04616	41932
16284	BT50 x ER32 - 150mm, slotted nut	150mm	1.97"	.788"	16089	04616	41932
16285	BT50 x ER40 - 80mm, slotted nut	80mm	2.48"	1.023"	16091	04617	41940
16289	BT50 x ER40 - 135mm, slotted nut	135mm	2.48"	1.023"	16091	04617	41940
06291	BT50 x ER50 - 90mm, slotted nut	90mm	3.07"	1.338"	16093	04618	41950

**Slot Nut Option:** Add "-SLOTNUT" to part number for ER16 and 20 slotted nuts

**Coolant Nut Option:** Add "-C" to part number. Coolant nuts are not available for ER50.

**DNA Option:** Add "-DNA" (ER16, ER20, & ER32)

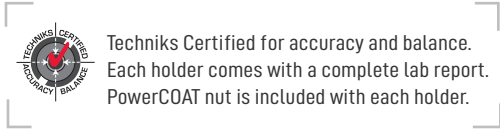

## FEATURES

- Balanced to 25,000 RPM at G2.5
- Maximum 0.0001" T.I.R. measured from taper to collet pocket
- PowerCOAT Nut increases holding power by 75%

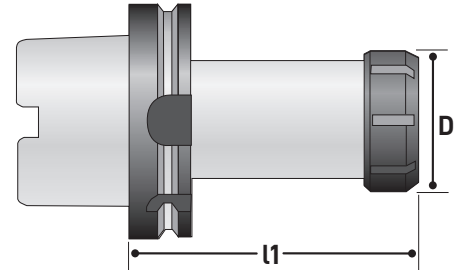

## HSK63A ER COLLET CHUCKS

Part No.	Description	l1	D	Wrench	Nut
31430	HSK63A x ER11 - 100mm, hex nut	100mm	19mm	04608	41116
31432	HSK63A x ER16 - 80mm, hex nut	80mm	28mm	04609	41116
31434	HSK63A x ER16 - 100mm, hex nut	100mm	28mm	04609	41116
31438	HSK63A x ER16 - 160mm, hex nut	160mm	28mm	04609	41116
31440	HSK63A x ER20 - 80mm, hex nut	80mm	34mm	04610	41120
31446	HSK63A x ER20 - 160mm, hex nut	160mm	34mm	04610	41120
31462	HSK63A x ER32 - 100mm, slotted nut	100mm	50mm	04616	41932
31466	HSK63A x ER32 - 160mm, slotted nut	160mm	50mm	04616	41932
31466-8T	HSK63A x ER32 - 8", tapered style, slot nut	8"	50mm	04616	41932
31468	HSK63A x ER40 - 80mm, slotted nut	80mm	63mm	04617	41940
31472	HSK63A x ER40 - 120mm, slotted nut	120mm	63mm	04617	41940
31476-8T	HSK63A x ER40 - 8", tapered style, slot nut	8"	63mm	04617	41940

## HSK 32A / 40A / 50A ER COLLET CHUCKS

Part No.	Description	l1	D	Wrench	Nut
31278	HSK32A x ER20 - 80mm, slotted nut	80mm	34mm	04614	41920
31284	HSK32A x ER25 - 80mm, mini nut	80mm	35mm	04624	23120
31374	HSK40A x ER11 - 80mm, mini nut	80mm	16mm	04621	23111
31376	HSK40A x ER16 - 80mm, hex nut	80mm	28mm	04609	41116
31384	HSK40A x ER25 - 80mm, slotted nut	80mm	35mm	04615	41925
31385	HSK40A x ER32 - 80mm, slotted nut	80mm	50mm	04616	41932
31420	HSK50A x ER32 - 100mm, slotted nut	100mm	50mm	04616	41932

**Slot Nut Option:** Add "-SLOTNUT" to part number for ER16 and 20 slotted nuts

**Coolant Nut Option:** Add "-C" to part number.

**DNA Option:** Add "-DNA" (ER16, ER20, & ER32)

# HSK-E/F ER COLLET CHUCKS



pg. 44



pg. 62



pg. 64



pg. 229



pg. 236



pg. 238

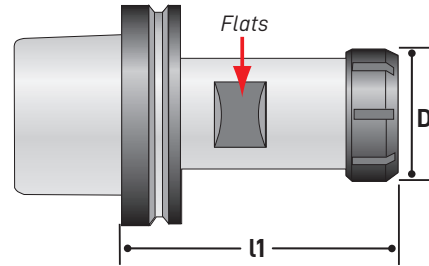

## HSK 32E / 40E / 50E / 63E ER COLLET CHUCKS

Part No.	Description	l1	D	Stop Screw	Wrench	Nut	Flats
31374-60-E	HSK32E x ER25 - 60mm, slotted nut	60mm	42mm	16089	04615	46125	22mm
31376-E	HSK40E x ER16 - 65mm, slotted nut	65mm	32mm	16083	04613	46116	24mm
31383-E	HSK40E x ER25 - 75mm, slotted nut	75mm	42mm	16089	04615	46125	27mm
31386-E	HSK40E x ER32 - 100mm, slotted nut	100mm	50mm	16089	04616	46132	35mm
31402-E	HSK50E x ER16 - 80mm, slotted nut	80mm	28mm	16083	04613	46116	27mm
31419-E	HSK50E x ER32 - 85mm, slotted nut	85mm	50mm	16089	04616	46132	36mm
31456-E	HSK63E x ER32 - 90mm, slotted nut	90mm	50mm	16089	04616	46132	36mm
31472-E	HSK63E x ER40 - 120mm, slotted nut	120mm	63mm	16091	04617	46140	46mm
50001	HSK63E x ER40 - 75mm, slotted nut	75mm	63mm	16091	04617	46140	46mm

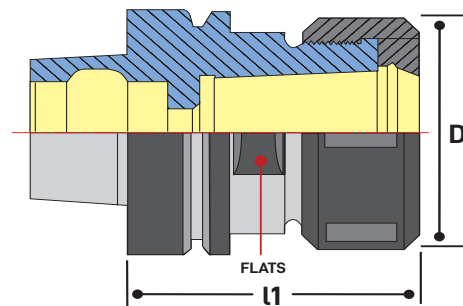

## HSK 50F / 63F ER COLLET CHUCKS

Part No.	Description	l1	D	Wrench	Nut	Flats
31419-F	HSK50F x ER32 - 80mm, slotted nut	80mm	50mm	04616	46132	36mm
103.123.11.100	HSK63F x ER11 - 100mm, mini nut	100mm	16mm	04621	23111	-
31431-F	HSK63F x ER16 - 60mm, slotted nut	60mm	32mm	04613	46116	26mm
31434-F	HSK63F x ER16 - 100mm, slotted nut	100mm	32mm	04613	46116	26mm
30000	HSK63F x ER32 - 70mm, slotted nut	70mm	50mm	04616	46132	36mm
30001	HSK63F x ER40 - 75mm, slotted nut	75mm	63mm	04617	46140	46mm
30001-L	HSK63F x ER40 - 75mm, left-hand thread	75mm	63mm	04617	46140-L	46mm
30001-Solid	HSK63F x ER40 - 75mm, No thru hole	75mm	63mm	04617	46140	46mm
30002	HSK63F x ER40 - 90mm, slotted nut	90mm	63mm	04617	46140	46mm
30003	HSK63F x ER40 - 115mm, slotted nut	115mm	63mm	04617	46140	46mm
30005	HSK63F x ER40 - 125mm, slotted nut	125mm	63mm	04617	46140	46mm
31025F	HSK63 F x SYOZ 25 - 80mm, slotted nut	80mm	60mm	83691	83632	38mm

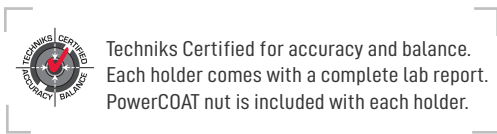

## FEATURES

- Balanced to 25,000 RPM at G2.5
- Maximum 0.0001" T.I.R. measured from taper to collet pocket
- PowerCOAT Nut increases holding power by 75%

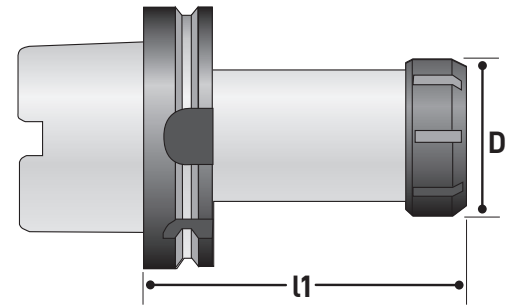

## HSK100A ER COLLET CHUCKS

Part No.	Description	l1	D	Wrench	Nut
31484	HSK100A x ER16 - 100mm, hex nut	100mm	28mm	04609	41116
31486	HSK100A x ER16 - 160mm, hex nut	160mm	28mm	04609	41116
31490	HSK100A X ER20 - 100mm, hex nut	100mm	34mm	04610	41120
31492	HSK100A X ER20 - 160mm, hex nut	160mm	34mm	04610	41120
31494	HSK100A X ER25 -100mm, slotted nut	100mm	35mm	04615	41925
31498	HSK100A x ER32 - 100mm, slotted nut	100mm	50mm	04616	41932
31503	HSK100A x ER32 - 160mm, slotted nut	160mm	50mm	04616	41932
31506	HSK100A x ER40 - 120mm, slotted nut	120mm	63mm	04617	41940

**Slot Nut Option:** Add "-SLOTNUT" to part number for ER16 and 20 slotted nuts

**Coolant Nut Option:** Add "-C" to part number.

**DNA Option:** Add "-DNA" (ER16, ER20, & ER32)

## HSK COOLANT PIPE AND WRENCHES

Part No.	Description	HSK-AE	D	T	Wrench
92002	Coolant Pipe	40	8mm	M12 x 1	91.11.026.002
92003	Coolant Pipe	50	10mm	M16 x 1	92.11.026.003
92004	Coolant Pipe	63	12mm	M18 x 1	93.11.026.004
92005	Coolant Pipe	100	16mm	M24 x 1.5	95.11.026.005

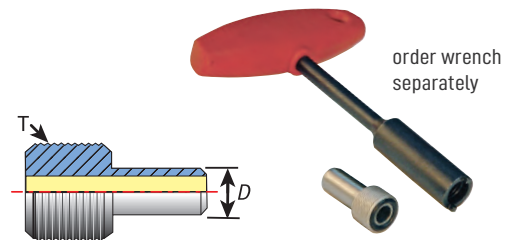



# CAT TG COLLET CHUCKS



pg. 44



pg. 62



pg. 64



pg. 229



pg. 236



pg. 238



## FEATURES

- Balanced to 25,000 RPM at G2.5
- Maximum 0.0001" T.I.R. measured from taper to collet pocket
- PowerCOAT Nut increases holding power by 75%



Techniks Certified for accuracy and balance. Each holder comes with a complete lab report. PowerCOAT nut is included with each holder.

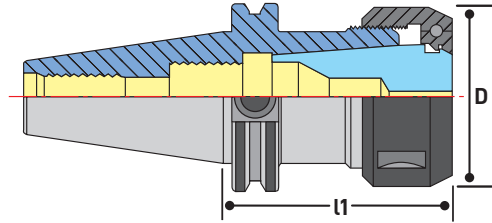

Coolant Stop Screws page 41.

## TG75 / TG100 COLLET CHUCKS

Part No.	Description	l1	D	Collet Range	Stop Screw	Wrench	Nut
23008	CAT40 x TG75 - 2.75"	2.75"	1.88"	.094 - .750"	16089	04018	84012
23014	CAT40 x TG100 - 3"	3"	2.362"	.094 - 1.0"	16093	83691	28110
23016	CAT40 x TG100 - 4"	4"	2.362"	.094 - 1.0"	16093	83691	28110
23018	CAT40 x TG100 - 6"	6"	2.362"	.094 - 1.0"	16093	83691	28110
23030	CAT50 x TG100 - 3"	3"	2.362"	.094 - 1.0"	16093	83691	28110
23032	CAT50 x TG100 - 4"	4"	2.362"	.094 - 1.0"	16093	83691	28110
23034	CAT50 x TG100 - 6"	6"	2.362"	.094 - 1.0"	16093	83691	28110
23035	CAT50 x TG100 - 8"	8"	2.362"	.094 - 1.0"	16093	83691	28110

Coolant Nut Option: Add "-C" to part number.



Techniks Certified for accuracy and balance. Each holder comes with a complete lab report. PowerCOAT nut is included with each holder.

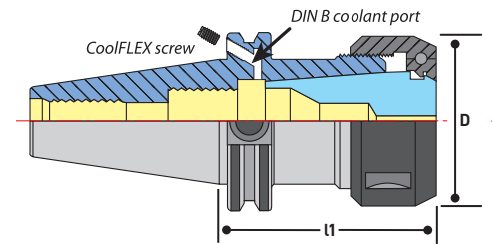

## COOLFLEX FEATURE

CoolFLEX holders are factory set for coolant-thru spindle. Remove the stop screws for DIN B coolant-thru flange.

Part No.	Description
HSA-4-6	40 taper DIN B screw
HSA-6-6	50 taper DIN B screw

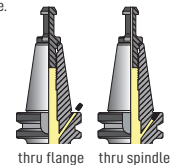

## TG100 COLLET CHUCKS COOLFLEX

Part No.	Description	l1	D	Collet	Collet Range	Stop Screw	Wrench	Nut
23014F	CAT40 CoolFLEX x TG100 - 3"	3"	2.362"	TG100	.094 - 1.0"	16093	83691	28110
23016F	CAT40 CoolFLEX x TG100 - 4"	4"	2.362"	TG100	.094 - 1.0"	16093	83691	28110
23018F	CAT40 CoolFLEX x TG100 - 6"	6"	2.362"	TG100	.094 - 1.0"	16093	83691	28110
23030F	CAT50 CoolFLEX x TG100 - 3"	3"	2.362"	TG100	.094 - 1.0"	16093	83691	28110

Coolant Nut Option: Add "-C" to part number.

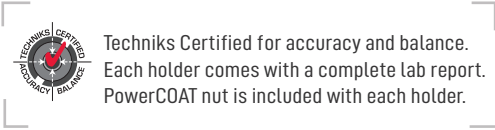

## FEATURES

- Balanced to 25,000 RPM at G2.5
- Maximum 0.0001" T.I.R. measured from taper to collet pocket
- PowerCOAT Nut increases holding power by 75%

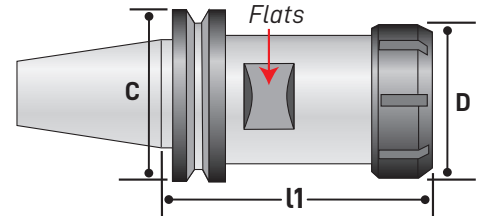

## ISO 20 / ISO 25 ER COLLET CHUCKS

Part No.	Description	l1	D	Wrench	Nut	Flats
16000-2016MC	*ISO 20 x ER16 - 52mm, HS mini nut & pull stud	52mm	22mm	04622	53116	17mm
16000-2516	ISO 20 x ER16 - 52mm, slotted nut & pull stud	52mm	32mm	04613	46116	17mm
16000-2520	ISO 20 x ER20 - 52mm, slotted nut & pull stud	52mm	35mm	04614	46120	17mm
12194-ISO25	ISO 25 x ER25 - 50mm, slotted nut & pull stud	50mm	42mm	04615	46125	27mm
25077	ISO 25 x ER25 - 65mm, slotted nut & pull stud	65mm	42mm	04615	46125	27mm

\*Balanced to 50,000 RPM. Use for Haas OM-1A, OM-2A Office Mills. Haas is trademark of Haas Automation and used here for identification only.

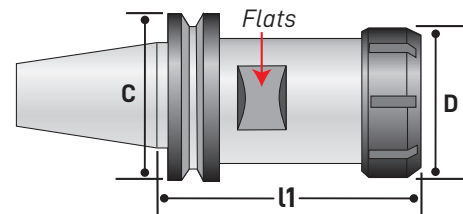

## ISO 30 / SK 30 ER COLLET CHUCKS

Part No.	Description	l1	D	Wrench	Nut	Flats
42407-W	ISO 30 x ER11 - 100mm, mini nut	100mm	16mm	04621	23111	14mm
42213-W-50	ISO 30 x ER32 - 50mm, slotted nut	50mm	50mm	04616	46132	47mm
42213-W-63	ISO 30 x ER32 - 63mm, slotted nut	63mm	50mm	04616	46132	36mm
42213-W-90	ISO 30 x ER32 - 90mm, slotted nut	90mm	50mm	04616	46132	36mm
12000-CMS	ISO 30 x ER32 - CMS toolholder	58mm	50mm	04616	46132	36mm
12040-CMS	ISO 30 x ER40 - CMS toolholder	66mm	63mm	04617	46140	42mm
42215-W-57	ISO 30 x ER40 - 57mm, slotted nut	57mm	63mm	04617	46140	47mm
42261-W	ISO 40 x ER40 - 70mm, slotted nut	70mm	63mm	04617	46140	46mm
NT-54300130	SK-30 x SYOZ 25 - 63mm	63mm	60mm	03691	83632	38mm

# STRAIGHT SHANK EXTENSIONS



pg. 44



pg. 62



pg. 64



pg. 229



pg. 236



pg. 238



Techniks Certified for accuracy.  
Each holder comes with a complete lab report.  
PowerCOAT nut is included with each holder.

## FEATURES

- Balanced to 25,000 RPM at G2.5
- Maximum 0.0001" T.I.R. measured from taper to collet pocket
- PowerCOAT Nut increases holding power by 75%

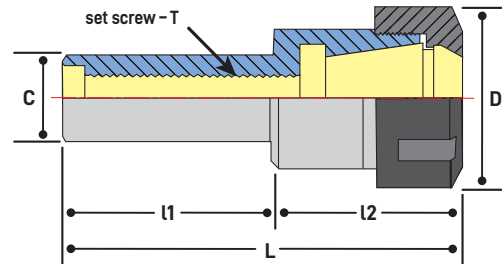

Coolant Stop Screws page 41.

## STRAIGHT SHANK EXTENSIONS

Part No.	Description	L	l1	l2	C	D	Stop Screw	Wrench	Nut
04851	16mm x ER11 - 140mm, hex nut	174.5mm	140mm	21.6mm	16mm	19mm	-	04608	41111
04855	1/2" x ER11 - 140mm, hex nut	174.5mm	140mm	21.6mm	1/2"	19mm	-	04608	41111
04854	5/8" x ER11 - 140mm, hex nut	174.5mm	140mm	21.6mm	5/8"	19mm	-	04608	41111
04832	5/8" x ER16 - 60mm, hex nut	95.1mm	60mm	35.1mm	5/8"	28mm	-	04609	41116
04834	3/4" x ER16 - 50mm, hex nut	85.1mm	50mm	35.1mm	3/4"	28mm	16083	04609	41116
04835	3/4" x ER16 - 100mm, hex nut	135.1mm	100mm	35.1mm	3/4"	28mm	16083	04609	41116
04856	3/4" x ER16 - 140mm, hex nut	175.1mm	140mm	35.1mm	3/4"	28mm	16083	04609	41116
04836-2.5	3/4" x ER20 - 2-1/2", hex nut	100mm	2-1/2"	38mm	3/4"	34mm	16083	04610	41120
04858	1" x ER20 - 140mm, hex nut	180.5mm	140mm	40.5mm	1"	34mm	16083	04610	41120
04837	1" x ER25 - 50mm, slotted nut	101mm	50mm	51mm	1"	42mm	16089	04615	41925
04817	20mm x ER32 - 50mm, slotted nut	97.1mm	50mm	47mm	20mm	50mm	16089	04616	41932
04818	20mm x ER32 - 100mm, slotted nut	146.5mm	100mm	47mm	20mm	50mm	16083	04616	41932
04818-150	20mm x ER32 - 150mm, slotted nut	196.5mm	150mm	47mm	20mm	50mm	16083	04616	41932
04839	1" x ER32 - 50mm, slotted nut	101.5mm	50mm	51.5mm	1"	50mm	16089	04616	41932
04839-140	1" x ER32 - 140mm, slotted nut	191.5mm	140mm	51.5mm	1"	50mm	16083	04616	41932
04843	1-1/4" x ER32 - 60mm, slotted nut	111.5mm	60mm	51.5mm	1-1/4"	50mm	16089	04616	41932
04841	1" x ER40 - 50mm, slotted nut	115mm	50mm	65mm	1"	63mm	16083	04617	41940

# STRAIGHT SHANK EXTENSIONS



 Technics Certified for accuracy and balance. Each holder comes with a complete lab report. PowerCOAT nut is included with each holder.

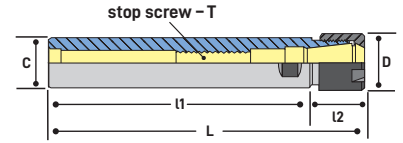
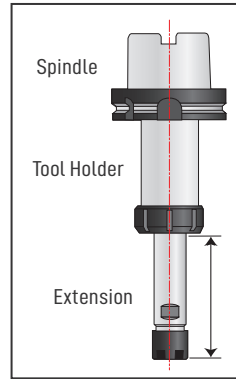

Extension length should not exceed a 4 : 1 ratio of length to diameter.

Example: A 1/2" shank should not extend more than 2" in front of the holder.

## STRAIGHT SHANK ER EXTENSIONS **MINI-NUT**

Part No.	Description	L	l1	l2	C	D	Stop Screw	Wrench	Nut
04889	3/8" x ER8 - 100mm, mini nut	124mm	100mm	24mm	3/8"	12mm	-	04620	23108
04891	1/2" x ER11 - 140mm, mini nut	166.5mm	140mm	26.5mm	1/2"	16mm	-	04621	23111
04893	5/8" x ER11 - 140mm, mini nut	158.5mm	140mm	18.5mm	5/8"	16mm	-	04621	23111
04895	1/2" x ER16 - 140mm, mini nut	177mm	140mm	37mm	1/2"	22mm	-	04622	23116
04896	3/4" x ER16 - 140mm, mini nut	165mm	140mm	25mm	3/4"	22mm	16083	04622	23116
04892	1/2" x ER20 - 140mm, mini nut	180mm	140mm	40mm	1/2"	28mm	16083	04623	23120
04894	3/4" x ER20 - 140mm, mini nut	180mm	140mm	40mm	3/4"	28mm	16083	04623	23120
04881	20mm x ER20 - 180mm, mini nut	220mm	180mm	40mm	20mm	28mm	16083	04623	23120
04897	1" x ER20 - 140mm, mini nut	168mm	140mm	28mm	1"	28mm	16083	04623	23120
04898	3/4" x ER25 - 100mm, mini nut	149mm	100mm	49mm	3/4"	35mm	16087	04624	23125
04888	1" x ER25 - 140mm, mini nut	190mm	140mm	50mm	1"	35mm	16083	04624	23125



## FEATURES

- For coolant up to 1,500 PSI
- Collet pocket T.I.R. 0.0001"
- PowerCOAT coolant nut included

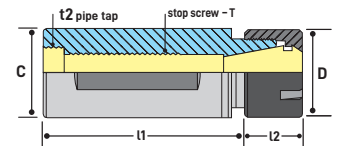

Use with Black Gold ER coolant rings for coolant-thru 04808C available with 1/8" NPT side entry coolant.

## STRAIGHT SHANK ER EXTENSIONS **COOLANT-THRU**

Part No.	Description	l1	l2	C	t2	D	T	Wrench
04802-C	3/4" x ER16 - 2" shank, coolant mini nut	1.65"	.916"	3/4"	1/4" NPT	22mm	M10 x 1.5	04622
04803-C	3/4" x ER16 - 3" shank, coolant mini nut	2.44"	.916"	3/4"	1/4" NPT	22mm	M10 x 1.5	04622
04804-C	3/4" x ER16 - 4" shank, coolant mini nut	3.42"	.916"	3/4"	1/4" NPT	22mm	M10 x 1.5	04622
04805-C	1" x ER20 - 3" shank, coolant mini nut	2.01"	1.07"	1"	3/8" NPT	28mm	M12 x 1.75	04623
04806-C	1" x ER20 - 4" shank, coolant mini nut	3.31"	1.07"	1"	3/8" NPT	28mm	M12 x 1.75	04623
04808-C	1.25" x ER32 - 2.36" shank, slotted nut	2.36"	2.16"	1-1/4"	3/8" NPT	50mm	M12 x 1.75	04616

Coolant Nut Option: Add "-C" to part number.



# STRAIGHT SHANK ER EXTENSIONS



pg. 44



pg. 62



pg. 64



pg. 229



pg. 236



pg. 238

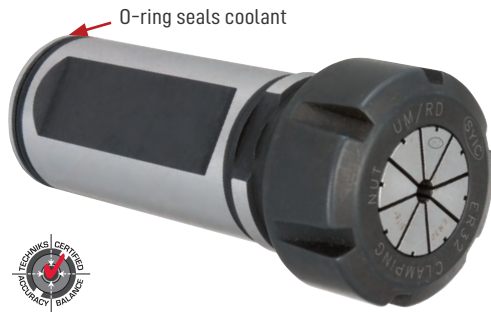

## FEATURES

- For coolant up to 1,500 PSI
- Collet pocket T.I.R. 0.0001"
- PowerCOAT nut included

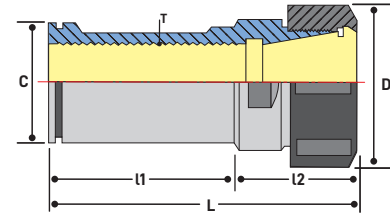

Perfect for CNC lathes and tapping applications. Seals coolant from the turret to the shank with an O-ring.

## STRAIGHT SHANKS ER EXTENSIONS COOLANT-THRU

Part No.	Description	L	L1	L2	C	D	T	Wrench	Nut
04782	1-1/4" x ER25 - 60mm shank	97mm	60mm	37mm	1-1/4"	42mm	M18 x 1.5	04615	41925
04784	1-1/4" x ER32 - 60mm shank	103mm	60mm	43mm	1-1/4"	50mm	M22 x 1.5	04616	41932
04788	1-1/2" x ER32 - 80mm shank	118mm	80mm	38mm	1-1/2"	50mm	M22 x 1.5	04616	41932
04786	1-1/4" x ER40 - 60mm shank	120mm	60mm	60mm	1-1/4"	63mm	M28 x 1.5	04617	41940
04790	1-1/2" x ER40 - 75mm shank	135mm	75mm	60mm	1-1/2"	63mm	M28 x 1.5	04617	41940

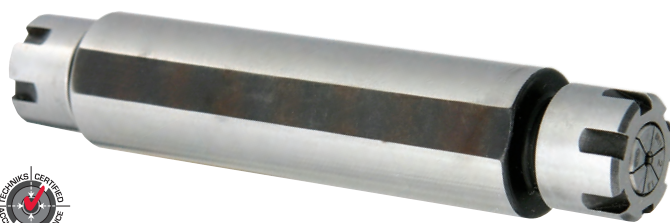

## FEATURES

- Collet pocket T.I.R. 0.0001"
- Wrench flats extend full length of shank

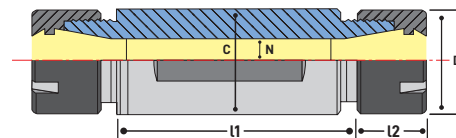

## DOUBLE-ENDED STRAIGHT SHANK SWISS-STYLE LATHES

Part No.	Description	L1	L2	C	D	N	Wrench
04801-DE	3/4" x ER11 - 2.5" shank, double ended mini nut	44mm	12mm	3/4"	16mm	8mm	04621
04802-DE	3/4" x ER11 - 3.35" shank, double ended mini nut	65mm	12mm	3/4"	16mm	8mm	04621
04803-DE	3/4" x ER11 - 4" shank, double ended mini nut	77mm	12mm	3/4"	16mm	8mm	04621
04804-DE	3/4" x ER11 - 5" shank, double ended mini nut	99.5mm	12mm	3/4"	16mm	8mm	04621



## SLIMFIT EXTENDED REACH COLLET CHUCKS

EXTREME PRECISION, SLIM DESIGN AND EXTENDED REACH.

SlimFIT is the best collet-based system for cutting tool shanks from 3/32" up to 1/4" when cutting at extended lengths or when clearance is required. SlimFIT collets are longer and more powerful than ER collets and provide better accuracy and performance for small diameter cutting tools.



### FEATURES

- .550" nose diameters
- Balanced to a minimum of 25,000 RPM at G2.5
- "On-Size" collets

### ADVANTAGES OF SLIMFIT TOOL DESIGN

The drawbar tightening system reduces nose diameter. Powerful 4° taper collets improve performance when holding tool shanks from 3/32" to 1/4" (3mm-6mm). Perform fast tool changes using a T-wrench.

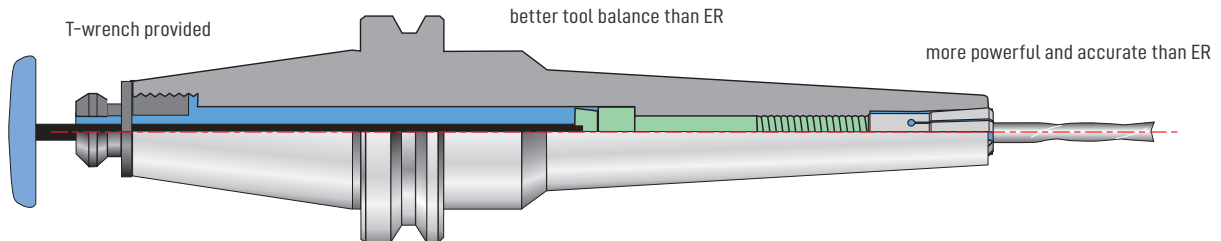

**YOU LOSE 10% OF TOOL LIFE FOR EVERY .0001" OF T.I.R.  
SLIMFIT CHUCKS OFFER EXCELLENT ACCURACY AT EXTENDED LENGTHS.**

# CAT SLIMFIT COLLET CHUCKS



pg. 44



pg. 62



pg. 64



pg. 229



pg. 236



pg. 238



## FEATURES

- .550" nose diameters
- Balanced to a minimum of 25,000 RPM at G2.5
- "On-Size" collets

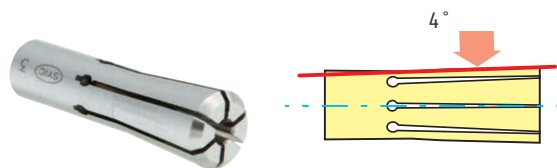
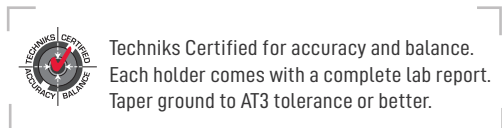

SlimFIT SBL6 holders feature 4° collets and a powerful drawbar tightening system that holds small diameter tools tighter and more accurately than ER systems. For tool shanks 3/32" up to 1/4" (3mm-6mm).

Tool changes do not require tightening fixtures or torque wrenches and can be performed using the supplied T-wrench.

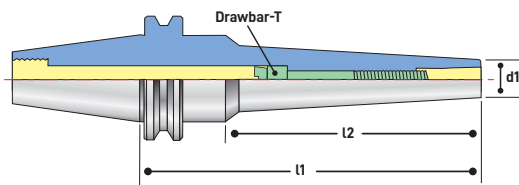

## CAT SLIMFIT ER COLLET CHUCKS

Part No.	Description	l1	l2	d1	Drawbar-T
23654	CAT40 x SBL6 - 3" SlimFIT	3"	1.625"	.550"	SYIC-SBL-M6C-60
23656	CAT40 x SBL6 - 4" SlimFIT	4"	2.625"	.550"	SYIC-SBL-M6C-35
23658	CAT40 x SBL6 - 6" SlimFIT	6"	4.625"	.550"	SYIC-SBL-M6CT-78
23659	CAT40 x SBL6 - 8" SlimFIT	8"	6.622"	.550"	SYIC-SBL-M6CT-130
23672	CAT50 x SBL6-3.5" SlimFIT	3.5"	2.12"	.550"	SYIC-SBL-M6C-65
23676	CAT50 x SBL6-6" SlimFIT	6"	4.622"	.550"	SYIC-SBL-M6CT-78

## SLIMFIT ACCESSORIES

Part No.	Description
T20S0TK1A81F	100mm T-Handle
T20L3TKIA81F	200mm slim shaft fits coolant retention knobs

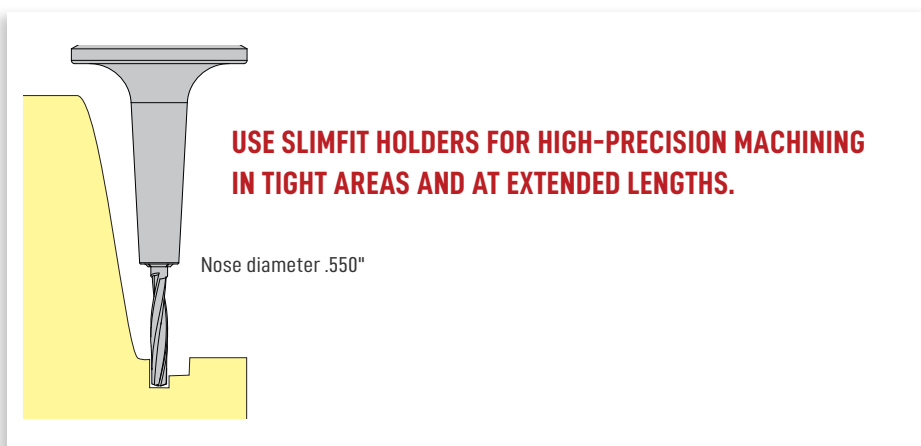



## FEATURES

- .550" nose diameters
- Balanced to a minimum of 25,000 RPM at G2.5
- "On-Size" collets

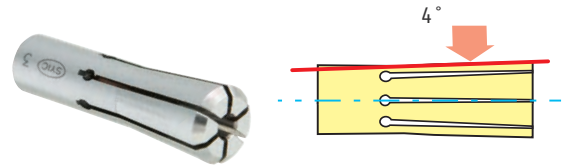

 Techniks Certified for accuracy and balance. Each holder comes with a complete lab report. Taper ground to AT3 tolerance or better.

SlimFIT SBL6 holders feature 4° collets and a powerful drawbar tightening system that holds small diameter tools tighter and more accurately than ER systems. For tool shanks 3/32" up to 1/4" (3mm-6mm).

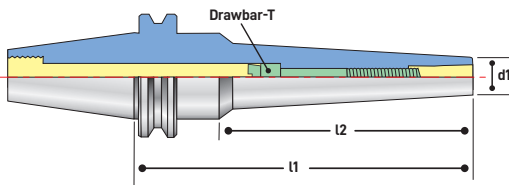

Tool changes do not require tightening fixtures or torque wrenches and can be performed using the supplied T-wrench.

## BT SLIMFIT ER COLLET CHUCKS

Part No.	Description	l1	l2	d1	Drawbar-T
18854	BT30 x SBL6-70	70mm	48mm	.550"	SYIC-SBL-M6C-45
18856	BT30 x SBL6-100	100mm	78mm	.550"	SYIC-SBL-M6C-65
18866	BT40 x SBL6-70	70mm	43mm	.550"	SYIC-SBL-M6C-45
18868	BT40 x SBL6-100	100mm	73mm	.550"	SYIC-SBL-M6CT-78
18868-150	BT40 x SBL6-150	150mm	123mm	.550"	SYIC-SBL-M6C-65
18869	BT40 x SBL6-200	200mm	173mm	.550"	SYIC-SBL-M6CT-130

## SLIMFIT ACCESSORIES

Part No.	Description
T20SOTK1A81F	100mm T-Handle
T20L3TKIA81F	200mm slim shaft fits coolant retention knobs

## WHY SLIMFIT OUT-PERFORMS ER COLLET SYSTEMS

SlimFIT collets are longer overall than ER collets and feature a 4° taper, delivering better engagement between collet and tool shank, resulting in better accuracy and balance than ER systems.

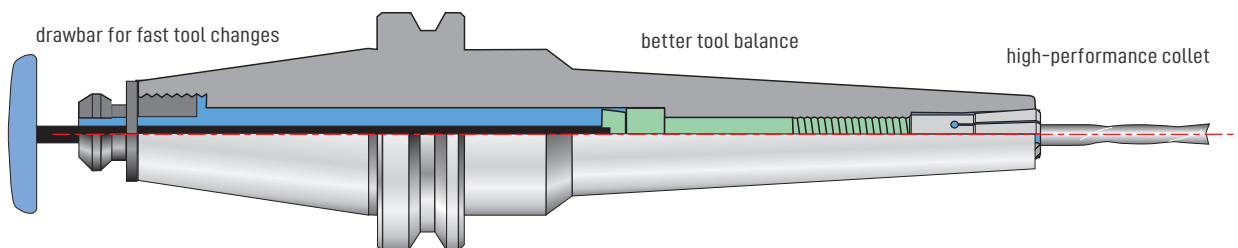



# HSK63A SLIMFIT COLLET CHUCKS



pg. 44



pg. 62



pg. 64



pg. 229



pg. 236



pg. 238



## FEATURES

- .550" nose diameters
- Balanced to a minimum of 25,000 RPM at G2.5
- "On-Size" collets

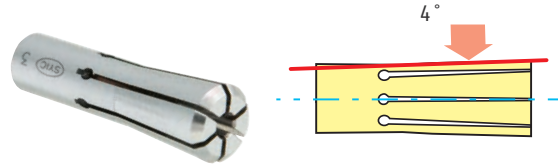

Techniks Certified for accuracy and balance. Each holder comes with a complete lab report.

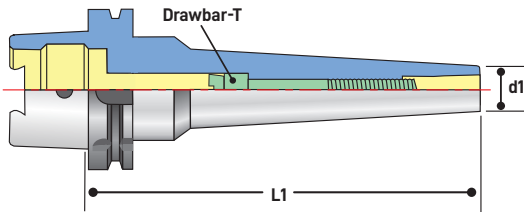

SlimFIT SBL6 holders feature 4° collets and a powerful drawbar tightening system that holds small diameter tools tighter and more accurately than ER systems. For tool shanks 3/32" up to 1/4" (3mm-6mm).

Tool changes do not require tightening fixtures or torque wrenches and can be performed using the supplied T-wrench.

## HSK63A SLIMFIT ER COLLET CHUCKS

Part No.	Description	l1	l2	d1	Drawbar-T
35470	HSK63A x SBL6-80 SlimFIT	80mm	54mm	.550"	SYIC-SBL-M6C-15
35472	HSK63A x SBL6-120 SlimFIT	120mm	94mm	.550"	SYIC-SBL-M6CT-50

## SLIMFIT ACCESSORIES

Part No.	Description
92004	HSK63A Coolant Pipe
93.11.026.004	Coolant Pipe Wrench
T20SOTK1A81F	100mm T-Handle
T20L3TKIA81F	200mm slim shaft fits coolant retention knobs

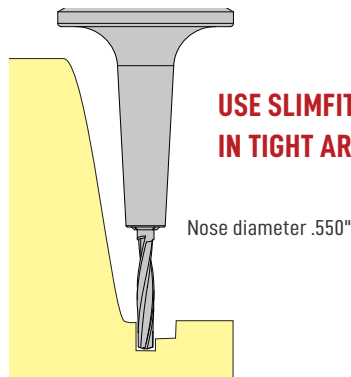

**USE SLIMFIT HOLDERS FOR HIGH-PRECISION MACHINING IN TIGHT AREAS AND AT EXTENDED LENGTHS.**

Nose diameter .550"



pg. 44



pg. 62



pg. 64



pg. 229



pg. 236



pg. 238



Techniks Certified for accuracy and balance. Each holder comes with a complete lab report.

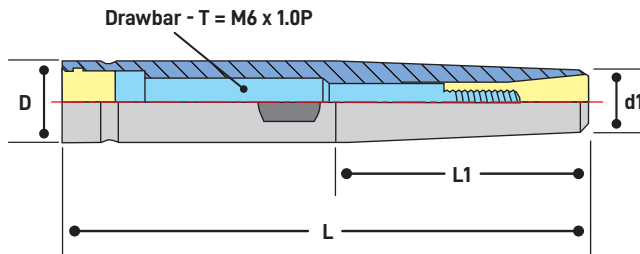

## SLIMFIT EXTENSIONS

Part No.	Description	D	L	L1	d1
06032-3	1/2" x OLP6-3" extension	.50"	3"	1.89"	.48
06032	1/2" x OLP6-5" extension	.50"	5"	1.89"	.48
06034	1/2" x OLP6-6" extension	.50"	6"	1.89"	.48
06038	5/8" x OLP6-5" extension	.625"	5"	1.89"	.48
06040	5/8" x OLP6-6" extension	.625"	6"	1.89"	.48
06042	5/8" x OLP6-8" extension	.625"	8"	1.89"	.48

Note: Extensions Fit 1/2" or 5/8" Toolholders

## FEATURES

- Only .480" nose diameter
- Use with any 1/2" or 5/8" toolholder, including end mill holders.
- 4° angle drawbar collet for greater holding power and accuracy

## EXTENSIONS CONVERT ANY 1/2" OR 5/8" TOOLHOLDER INTO A SLIMFIT TOOL!



Extensions feature a nose clearance of .480", providing access to areas unreachable by standard length tool holders.

**YOU LOSE 10% OF TOOL LIFE FOR EVERY .0001" OF T.I.R.  
SLIMFIT CHUCKS OFFER EXCELLENT ACCURACY AT EXTENDED LENGTHS.**





## FEATURES

- "On-Size" collets
- Precision ground and polished
- Each collet individually inspected for quality

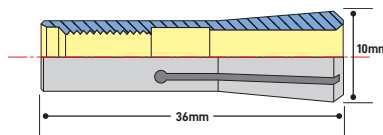

NOTE: TIGHTEN TO 9 FT/LBS

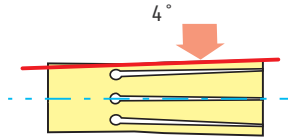

## SLIMFIT COLLET SET

Part No.	Description
18851-12IMS	SlimFIT 12 piece set

Convenient collet set provides the collets you need and the wooden tray prevents damage to collets.

### Set includes 12 collets:

INCH: 7/64", 1/8", 9/64", 11/64"

3/16", 13/64", 15/64", 1/4"

METRIC: 3mm, 4mm, 5mm, 6mm

## SLIMFIT COLLETS INCH

Part No.	Description
18851-3/32	SlimFIT 6 - 3/32" collet
18851-7/64	SlimFIT 6 - 7/64" collet
18851-1/8	SlimFIT 6 - 1/8" collet
18851-9/64	SlimFIT 6 - 9/64" collet
18851-5/32	SlimFIT 6 - 5/32" collet
18851-11/64	SlimFIT 6 - 11/64" collet
18851-3/16	SlimFIT 6 - 3/16" collet
18851-13/64	SlimFIT 6 - 13/64" collet
18851-7/32	SlimFIT 6 - 7/32" collet
18851-15/64	SlimFIT 6 - 15/64" collet
18851-1/4	SlimFIT 6 - 1/4" collet

## SLIMFIT COLLETS METRIC

Part No.	Description
18851-03	SlimFIT 6 - 3mm collet
18851-04	SlimFIT 6 - 4mm collet
18851-05	SlimFIT 6 - 5mm collet
18851-05.5	SlimFIT 6 - 5.5mm collet
18851-06	SlimFIT 6 - 6mm collet

## WHY SLIMFIT OUT-PERFORMS ER COLLET SYSTEMS

SlimFIT collets are longer overall than ER collets and feature a 4° taper, delivering better engagement between collet and tool shank, resulting in better accuracy and balance than ER systems.

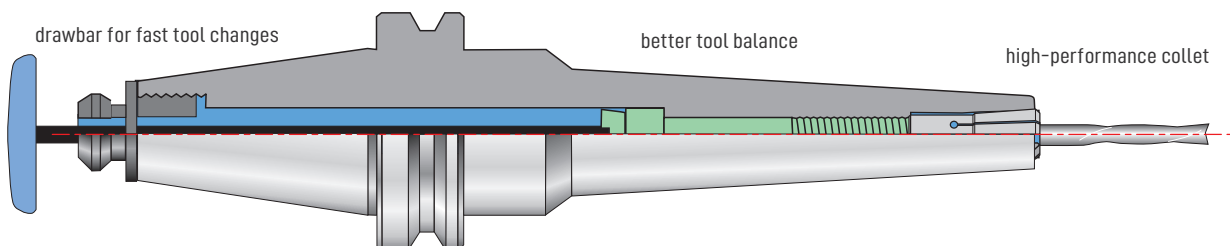



Use coolant stop screws for coolant-thru tools or with Black Gold Rings for CoolBLAST option using standard cutting tools.

See page 64 for more information.

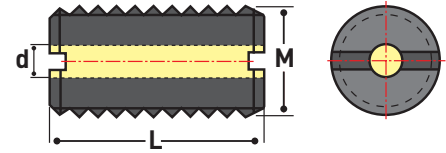

## COOLANT STOP SCREWS

Part No.	Description	M	L	d
16080C-20	Coolant Stop Screw	M5 x 0.8P	20mm	2.5
16081C-20	Coolant Stop Screw	M6 x 1.0P	20mm	3
16082C-20	Coolant Stop Screw	M8 x 1.25P	20mm	4
16083C-20	Coolant Stop Screw	M10 x 1.5P	20mm	4
16085C-20	Coolant Stop Screw	M12 x 1.75P	20mm	4
16089C-20	Coolant Stop Screw	M16 x 02.0P	20mm	5
16091C-20	Coolant Stop Screw	M20 x 2.0P	20mm	5

## RECOMMENDED COLLET NUT & RETENTION KNOB TIGHTENING TORQUE

Collet	Nut Type	Collets I.D. OVER 1/16" (2mm)	Collets I.D. UNDER 1/16" (2mm)	Order Torque Wrench Adapter
ER11	Mini	12 ft/lbs	10 ft/lbs	04576
ER11	Hex	17 ft/lbs	14 ft/lbs	04581
ER16	Mini	20 ft/lbs	16 ft/lbs	04578
ER16	Slotted	42 ft/lbs	30 ft/lbs	04580-16
ER16	Hex	42 ft/lbs	30 ft/lbs	04601-16
ER20	Mini	22 ft/lbs	18 ft/lbs	04578
ER20	Slotted	59 ft/lbs	24 ft/lbs	04580-20
ER20	Hex	59 ft/lbs	24 ft/lbs	04602-20
ER25	Mini	28 ft/lbs	28 ft/lbs	04587
ER25	Slotted	77 ft/lbs	77 ft/lbs	04603-25
ER32	Slotted	100 ft/lbs	100 ft/lbs	04604-32
ER40	Slotted	130 ft/lbs	130 ft/lbs	04605-40
SYOZ 25/TG100	Hook	95 ft/lbs	95 ft/lbs	03690-25
TG75	Hex	90 ft/lbs	90 ft/lbs	04604-32

Always tighten retention knobs to exact specification or damage to tooling or bodily harm may occur.

Retention Knobs	Wrench Flats	Drive	Torque	Order Socket
BT30 Taper	0.535"	1/4"	36 ft/lbs	PSS-30BT
ISO 30 Taper	0.535"	3/8"	36 ft/lbs	PSS-30ISO
Any 40 Taper	0.750"	3/8"	76 ft/lbs	PSS-40
BT50 Taper	1.187"	1/2"	99 ft/lbs	PSC-50
CAT50 Taper	1.250"	1/2"	99 ft/lbs	PSC-50

\*\*Always use a torque wrench and tightening stand when tightening collet nuts and retention knobs. Overtightening collet nuts will cause premature damage to collets and increase run-out.

## DIRECTIONS

- Snap collet into nut.
- Insert cutting tool into collet. Make sure shank extends to the bottom of the collet.
- Hand tighten collet nut assembly into toolholder.
- Insert toolholder assembly into tightening fixture and secure it.
- Tighten collet nut to recommended torque using a torque wrench and adapter.

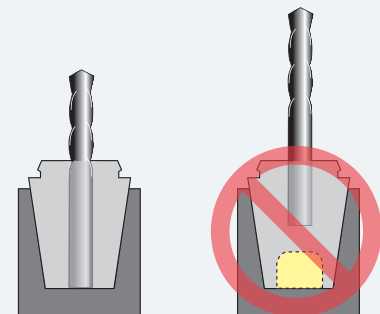

For maximum holding power fill the collet all the way with the tool shank (left) and use a PowerCOAT nut.





pg. 44



pg. 62



pg. 64



pg. 229



pg. 236



pg. 238

## V-FLANGE CNC MACHINE MAKE, MODEL AND SPINDLE

FILL IN ALL THE REQUIRED DIMENSIONS.  
CONTACT TECHNIKS YOUR ORDER FOR A FAST QUOTE.

PHONE: (800) 597-3921 OR EMAIL: INFO@TECHNIKSUSA.COM

### v-flange tool #1 dimensions

D = \_\_\_\_\_  
 F = \_\_\_\_\_  
 W = \_\_\_\_\_  
 A = \_\_\_\_\_  
 N = \_\_\_\_\_

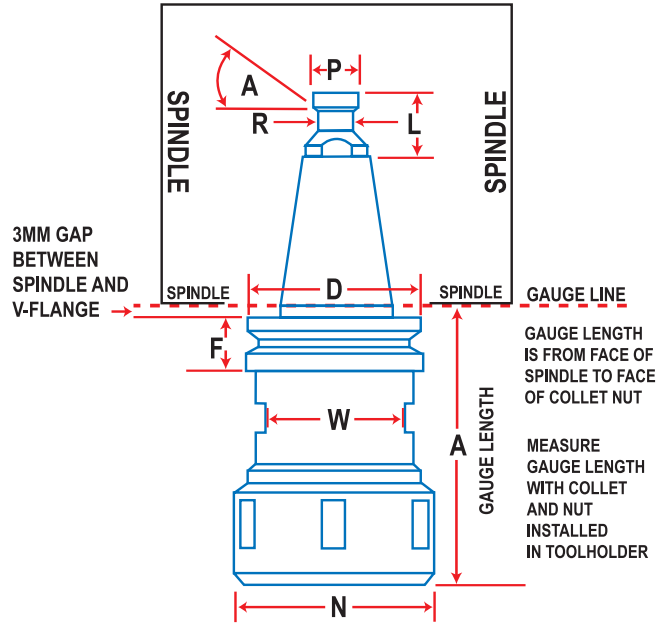

### v-flange tool #2 dimensions

D = \_\_\_\_\_  
 F = \_\_\_\_\_  
 W = \_\_\_\_\_  
 A = \_\_\_\_\_  
 N = \_\_\_\_\_

## HSK CNC MACHINE MAKE, MODEL AND SPINDLE

### HSK tool #1 dimensions

D = \_\_\_\_\_  
 F = \_\_\_\_\_  
 W = \_\_\_\_\_  
 A = \_\_\_\_\_  
 N = \_\_\_\_\_

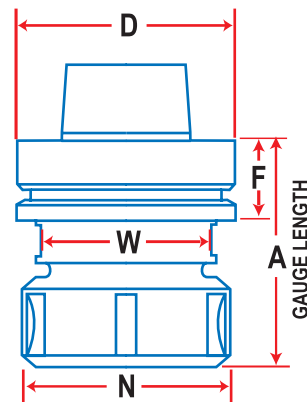

### HSK tool #2 dimensions

D = \_\_\_\_\_  
 F = \_\_\_\_\_  
 W = \_\_\_\_\_  
 A = \_\_\_\_\_  
 N = \_\_\_\_\_

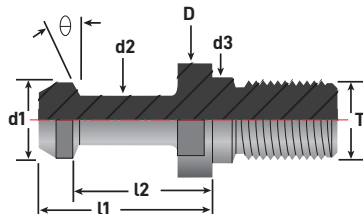

For special order retention knobs  
call (800) 597-3921.

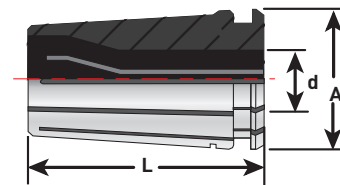

For special order collets see  
page 72 or call (800) 597-3921.



# TECHNIKS CERTIFIED COLLETS & NUTS

## QUALITY & PERFORMANCE GUARANTEED

### FULL LINE OF ER COLLETS

MADE FROM HIGH-CARBON BEARING STEEL AND HEAT-TREATED FOR IMPROVED FLEXIBILITY AND LONGER LIFE.



Inch & Metric

Sealed Coolant

Steel Sealed Coolant

Rigid Tap Collet

Quick-Change Tap Collet

Floating Tap Collet



"Dead Nuts Accurate"  
DNA ER Collets



TG75, TG100,  
TG150



SYOZ / EOC  
Perske



DA Double  
Angle

### POWERCOAT NUTS



PowerCOAT nut reduces friction so it can increase holding power by 75% compared to standard nuts.

### HOLDING POWER TESTING – FT/LBS

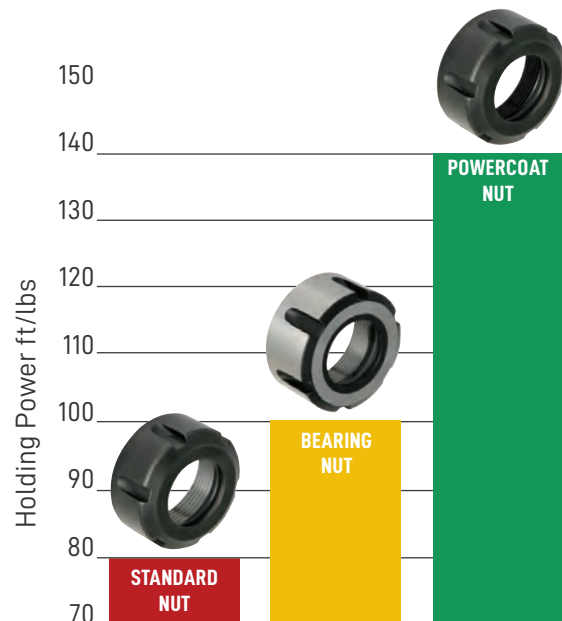



## FEATURES

- Average .0002" T.I.R.
- Collapse range: .039"
- Compatible with DR, RD, ESX, AR, & BR series collets.



## DIMENSIONS

Use this table for selecting your replacement collets. ER collets all have unique length and diameter measurements.

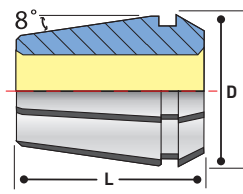

ER Size	L	D
ER8	13mm (.51")	8.5mm (.33")
ER11	18mm (.708")	11.5mm (.45")
ER16	27.5mm (1.08")	17mm (.67")
ER20	31.5mm (1.24")	21mm (.83")
ER25	34mm (1.34")	26mm (1.02")
ER32	40mm (1.57")	33mm (1.3")
ER40	46mm (1.81")	41mm (1.61")
ER50	60 mm (2.36")	52mm (2.05")

## ER COLLET SETS INCH

Part No.	Size	Pcs.	Collets Included	Fits Shank Sizes
04208IS	ER11	7	1/16 – 1/4" by 32nds	1/32 – 1/4"
04209IS	ER16	10	3/32 – 3/8" by 32nds	1/16 – 3/8"
04210IS	ER20	12	5/32 – 1/2" by 32nds	1/8 – 1/2"
04211IS	ER25	16	5/32 – 5/8" by 32nds	1/8 – 5/8"
04212IS	ER32	18	7/32 – 3/4" by 32nds	3/16 – 3/4"
04213IS	ER40	13	1/8 – 1.0" by 16ths	1/8 – 1.0"

NOTE: ER40 collet set does not include 13/16 and 15/16 size collets.

## ER8 COLLETS INCH

Part No.	Collapse Range	Shank
04208-1/16	.043 – .062"	1/16"
04208-1/8	.086 – .125"	1/8"
04208-3/16	.148 – .187"	3/16"

## ER11 COLLETS INCH

Part No.	Collapse Range	Shank
04211-1/16	.043 – .062"	1/16"
04211-3/32	.054 – .093"	3/32"
04211-1/8	.086 – .125"	1/8"
04211-5/32	.117 – .156"	5/32"
04211-3/16	.148 – .187"	3/16"
04211-7/32	.179 – .218"	7/32"
04211-1/4	.211 – .250"	1/4"
04211-9/32	.242 – .281"	9/32"

## ER16 COLLETS INCH

Part No.	Collapse Range	Shank
04216-1/16	.043 – .062"	1/16"
04216-3/32	.054 – .093"	3/32"
04216-1/8	.086 – .125"	1/8"
04216-5/32	.117 – .156"	5/32"
04216-3/16	.148 – .187"	3/16"
04216-7/32	.179 – .218"	7/32"
04216-1/4	.211 – .250"	1/4"
04216-9/32	.242 – .281"	9/32"
04216-5/16	.273 – .312"	5/16"
04216-11/32	.304 – .343"	11/32"
04216-3/8	.336 – .375"	3/8"
04216-13/32	.367 – .406"	13/32"

## ER20 COLLETS INCH

Part No.	Collapse Range	Shank
04220-1/16	.043 – .062"	1/16"
04220-3/32	.054 – .093"	3/32"
04220-1/8	.086 – .125"	1/8"
04220-5/32	.117 – .156"	5/32"
04220-3/16	.148 – .187"	3/16"
04220-7/32	.179 – .218"	7/32"
04220-1/4	.211 – .250"	1/4"
04220-9/32	.242 – .281"	9/32"
04220-5/16	.273 – .312"	5/16"
04220-11/32	.304 – .343"	11/32"
04220-3/8	.336 – .375"	3/8"
04220-13/32	.367 – .406"	13/32"
04220-7/16	.398 – .437"	7/16"
04220-15/32	.429 – .468"	15/32"
04220-1/2	.461 – .500"	1/2"



pg. 62



pg. 64



pg. 229



pg. 236



pg. 238

## ER25 COLLETS INCH

Part No.	Inch Range	Shank
04225-3/32	.054 - .093"	3/32"
04225-1/8	.086 - .125"	1/8"
04225-5/32	.117 - .156"	5/32"
04225-3/16	.148 - .187"	3/16"
04225-7/32	.179 - .218"	7/32"
04225-1/4	.211 - .250"	1/4"
04225-9/32	.242 - .281"	9/32"
04225-5/16	.273 - .312"	5/16"
04225-11/32	.304 - .343"	11/32"
04225-3/8	.336 - .375"	3/8"
04225-13/32	.367 - .406"	13/32"
04225-7/16	.398 - .437"	7/16"
04225-15/32	.429 - .468"	15/32"
04225-1/2	.461 - .500"	1/2"
04225-17/32	.492 - .531"	17/32"
04225-9/16	.523 - .562"	9/16"
04225-19/32	.554 - .593"	19/32"
04225-5/8	.586 - .625"	5/8"
04225-3/4	.711 - .750"	3/4"

## ER32 COLLETS INCH

Part No.	Inch Range	Shank
04232-1/16	.043 - .062"	1/16"
04232-3/32	.054 - .093"	3/32"
04232-1/8	.086 - .125"	1/8"
04232-5/32	.117 - .156"	5/32"
04232-3/16	.148 - .187"	3/16"
04232-7/32	.179 - .218"	7/32"
04232-1/4	.211 - .250"	1/4"
04232-9/32	.242 - .281"	9/32"
04232-5/16	.273 - .312"	5/16"
04232-11/32	.304 - .343"	11/32"
04232-3/8	.336 - .375"	3/8"
04232-13/32	.367 - .406"	13/32"
04232-7/16	.398 - .437"	7/16"
04232-15/32	.429 - .468"	15/32"
04232-1/2	.461 - .500"	1/2"
04232-17/32	.492 - .531"	17/32"
04232-9/16	.523 - .562"	9/16"
04232-19/32	.554 - .593"	19/32"
04232-5/8	.586 - .625"	5/8"
04232-21/32	.617 - .656"	21/32"
04232-11/16	.648 - .687"	11/16"
04232-23/32	.679 - .718"	23/32"
04232-3/4	.711 - .750"	3/4"

## ER40 COLLETS INCH

Part No.	Inch Range	Shank
04240-1/8	.086 - .125"	1/8"
04240-5/32	.117 - .156"	5/32"
04240-3/16	.148 - .187"	3/16"
04240-7/32	.179 - .218"	7/32"
04240-1/4	.211 - .250"	1/4"
04240-9/32	.242 - .281"	9/32"
04240-5/16	.273 - .312"	5/16"
04240-11/32	.304 - .343"	11/32"
04240-3/8	.336 - .375"	3/8"
04240-13/32	.367 - .406"	13/32"
04240-7/16	.398 - .437"	7/16"
04240-15/32	.429 - .468"	15/32"
04240-1/2	.461 - .500"	1/2"
04240-17/32	.492 - .531"	17/32"
04240-9/16	.523 - .562"	9/16"
04240-19/32	.554 - .593"	19/32"
04240-5/8	.586 - .625"	5/8"
04240-21/32	.617 - .656"	21/32"
04240-11/16	.648 - .687"	11/16"
04240-23/32	.679 - .718"	23/32"
04240-3/4	.711 - .750"	3/4"
04240-25/32	.742 - .781"	25/32"
04240-13/16	.773 - .812"	13/16"
04240-27/32	.807 - .843"	27/32"
04240-7/8	.836 - .875"	7/8"
04240-29/32	.867 - .906"	29/32"
04240-15/16	.898 - .937"	15/16"
04240-31/32	.929 - .968"	31/32"
04240-1	.961 - 1.00"	1.0"

**TRY TECHNIKS DEAD NUTS ACCURATE  
DNA COLLETS & NUTS SYSTEM**

For shank sizes 1/8" (3mm) or smaller use our DNA (dead nuts accurate) collet for improved results.

See page 48.



## ER50 COLLETS INCH

Part No.	Inch Range	Shank
04250-1/2	.461 - .500"	1/2"
04250-5/8	.586 - .625"	5/8"
04250-3/4	.711 - .750"	3/4"
04250-7/8	.836 - .875"	7/8"
04250-1	.961 - 1.00"	1.0"
04250-1-1/4	1.211 - 1.250"	1-1/4"

# ER COLLETS - METRIC



## FEATURES

- Average .0002" T.I.R.
- Clamping range: .039"
- Compatible with DR, RD, ESX, AR, & BR series collets.



## COLLET SETS METRIC

Part No.	Size	Pcs.	Collets Included	Fits Shank Sizes
04200MS	ER8	9	1 - 5mm by 0.5mm	.5 - 5mm
04201MS	ER11	13	1 - 7mm by 0.5mm	.5 - 7mm
04202MS	ER16	10	1 - 10mm by 1mm	.5 - 10mm
04203MS	ER20	12	2 - 13mm by 1mm	1.0 - 13mm
04204MS	ER25	15	2 - 16mm by 1mm	1.0 - 16mm
04205MS	ER32	18	3 - 20mm by 1mm	2 - 20mm
04206MS	ER40	23	4 - 26mm by 1mm	3 - 26mm
04207MS	ER50	17	6 - 34mm by 2 mm	5 - 34mm

## DIMENSIONS

Use this table for selecting your replacement collets. ER collets all have unique length and diameter measurements.

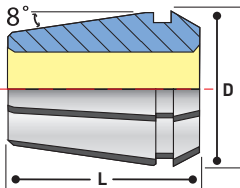

ER Size	L	D
ER8	13mm (.51")	8.5mm (.33")
ER11	18mm (.708")	11.5mm (.45")
ER16	27.5mm (1.08")	17mm (.67")
ER20	31.5mm (1.24")	21mm (.83")
ER25	34mm (1.34")	26mm (1.02")
ER32	40mm (1.57")	33mm (1.3")
ER40	46mm (1.81")	41mm (1.61")
ER50	60 mm (2.36")	52mm (2.05")

## ER8 COLLETS METRIC

Part No.	Inch Range	Shank
04208-01.0	.019 - .039"	0.5 - 1.0
04208-01.5	.039 - .059"	1.0 - 1.5
04208-02.0	.059 - .079"	1.5 - 2.0
04208-02.5	.079 - .098"	2.0 - 2.5
04208-03.0	.098 - .118"	2.5 - 3.0
04208-03.5	.118 - .138"	3.0 - 3.5
04208-04.0	.138 - .157"	3.5 - 4.0
04208-04.5	.157 - .177"	4.0 - 4.5
04208-05.0	.177 - .197"	4.5 - 5.0

## ER16 COLLETS METRIC

Part No.	Inch Range	Shank
04216-01	.019 - .039"	0.5-1.0
04216-01.5	.039 - .059"	1.0-1.5
04216-02	.039 - .079"	1.5-2.0
04216-02.5	.059 - .098"	1.5-2.5
04216-03	.079 - .118"	2.0-3.0
04216-03.5	.098 - .137"	2.5-3.5
04216-04	.118 - .157"	3.0-4.0
04216-04.5	.137 - .177"	3.5-4.5
04216-05	.157 - .197"	4.0-5.0
04216-05.5	.177 - .216"	4.5-5.5
04216-06	.197 - .236"	5.0-6.0
04216-06.5	.216 - .255"	5.5-6.5
04216-07	.236 - .276"	6.0-7.0
04216-07.5	.255 - .295"	6.5-7.5
04216-08	.276 - .315"	7.0-8.0
04216-08.5	.295 - .334"	7.5-8.5
04216-09	.315 - .354"	8.0-9.0
04216-09.5	.334 - .374"	8.5-9.5
04216-10	.354 - .394"	9.0-10.0
04216-10.5	.374 - .413"	9.5-10.5

## ER20 COLLETS METRIC

Part No.	Inch Range	Shank
04220-01	.019 - .039"	0.5-1.0
04220-01.5	.039 - .059"	1.0-1.5
04220-02	.039 - .079"	1.5-2.0
04220-02.5	.059 - .098"	1.5-2.5
04220-03	.079 - .118"	2.0-3.0
04220-03.5	.098 - .137"	2.5-3.5
04220-04	.118 - .157"	3.0-4.0
04220-04.5	.137 - .177"	3.5-4.5
04220-05	.157 - .197"	4.0-5.0
04220-05.5	.177 - .216"	4.5-5.5
04220-06	.197 - .236"	5.0-6.0
04220-06.5	.216 - .255"	5.5-6.5
04220-07	.236 - .276"	6.0-7.0
04220-07.5	.255 - .295"	6.5-7.5
04220-08	.276 - .315"	7.0-8.0
04220-08.5	.295 - .334"	7.5-8.5
04220-09	.315 - .354"	8.0-9.0
04220-09.5	.334 - .374"	8.5-9.5
04220-10	.354 - .394"	9.0-10.0
04220-10.5	.374 - .413"	9.5-10.5
04220-11	.394 - .433"	10.0-11.0
04220-11.5	.413 - .452"	10.5-11.5
04220-12	.433 - .472"	11.0-12.0
04220-12.5	.452 - .492"	11.5-12.5
04220-13	.472 - .512"	12.0-13.0
04220-13.5	.492 - .531"	12.5-13.5
04220-14	.512 - .551"	13.0-14.0

## ER11 COLLETS METRIC

Part No.	Inch Range	Shank
04211-01.0	.019 - .039"	0.5 - 1.0
04211-01.5	.039 - .059"	1.0 - 1.5
04211-02.0	.059 - .079"	1.5 - 2.0
04211-02.5	.079 - .098"	2.0 - 2.5
04211-03.0	.098 - .118"	2.5 - 3.0
04211-03.5	.118 - .138"	3.0 - 3.5
04211-04.0	.138 - .157"	3.5 - 4.0
04211-04.5	.157 - .177"	4.0 - 4.5
04211-05.0	.177 - .197"	4.5 - 5.0
04211-05.5	.197 - .217"	5.0 - 5.5
04211-06.0	.217 - .236"	5.5 - 6.0
04211-06.5	.236 - .256"	6.0 - 6.5
04211-07.0	.256 - .276"	6.5 - 7.0





pg. 62



pg. 64



pg. 229



pg. 236



pg. 238

## ER25 COLLETS METRIC

Part No.	Inch Range	Shank
04225-02	.039 - .079"	1.5-2.0
04225-02.5	.059 - .098"	2.0-2.5
04225-03	.079 - .118"	2.0-3.0
04225-03.5	.098 - .137"	2.5-3.5
04225-04	.118 - .157"	3.0-4.0
04225-05	.157 - .197"	4.0-5.0
04225-06	.197 - .236"	5.0-6.0
04225-07	.236 - .276"	6.0-7.0
04225-08	.276 - .315"	7.0-8.0
04225-09	.315 - .354"	8.0-9.0
04225-10	.354 - .394"	9.0-10.0
04225-11	.394 - .433"	10.0-11.0
04225-12	.433 - .472"	11.0-12.0
04225-13	.472 - .512"	12.0-13.0
04225-14	.512 - .551"	13.0-14.0
04225-15	.551 - .591"	14.0-15.0
04225-16	.591 - .630"	15.0-16.0
04225-17	.630 - .669"	16.0-17.0

## ER32 COLLETS METRIC

Part No.	Inch Range	Shank
04232-03	.079 - .118"	2.0-3.0
04232-03.5	.098 - .137"	2.5-3.5
04232-04	.118 - .157"	3.0-4.0
04232-04.5	.137 - .177"	3.5-4.5
04232-05	.157 - .197"	4.0-5.0
04232-05.5	.177 - .216"	4.5-5.5
04232-06	.197 - .236"	5.0-6.0
04232-06.5	.216 - .255"	5.5-6.5
04232-07	.236 - .276"	6.0-7.0
04232-07.5	.255 - .295"	6.5-7.5
04232-08	.276 - .315"	7.0-8.0
04232-08.5	.295 - .334"	7.5-8.5
04232-09	.315 - .354"	8.0-9.0
04232-09.5	.334 - .374"	8.5-9.5
04232-10	.354 - .394"	9.0-10.0
04232-10.5	.374 - .413"	9.5-10.5
04232-11	.394 - .433"	10.0-11.0
04232-11.5	.413 - .452"	10.5-11.5
04232-12	.433 - .472"	11.0-12.0
04232-12.5	.452 - .492"	11.5-12.5
04232-13	.472 - .512"	12.0-13.0
04232-13.5	.492 - .531"	12.5-13.5
04232-14	.512 - .551"	13.0-14.0
04232-14.5	.531 - .570"	13.5-14.5
04232-15	.551 - .591"	14.0-15.0
04232-15.5	.570 - .610"	14.5-15.5
04232-16	.591 - .630"	15.0-16.0
04232-16.5	.610 - .649"	15.5-16.5
04232-17	.630 - .669"	16.0-17.0
04232-17.5	.649 - .688"	16.5-17.5
04232-18	.669 - .709"	17.0-18.0
04232-18.5	.688 - .728"	17.5-18.5
04232-19	.709 - .748"	18.0-19.0
04232-19.5	.728 - .767"	18.5-19.5
04232-20	.748 - .787"	19.0-20.0
04232-21	.787 - .827"	20.0-21.0

## ER40 COLLETS METRIC

Part No.	Inch Range	Shank
04240-04	.118 - .157"	3.0-4.0
04240-05	.157 - .197"	4.0-5.0
04240-06	.197 - .236"	5.0-6.0
04240-07	.236 - .276"	6.0-7.0
04240-08	.276 - .315"	7.0-8.0
04240-09	.315 - .354"	8.0-9.0
04240-10	.354 - .394"	9.0-10.0
04240-11	.394 - .433"	10.0-11.0
04240-12	.433 - .472"	11.0-12.0
04240-13	.472 - .512"	12.0-13.0
04240-14	.512 - .551"	13.0-14.0
04240-15	.551 - .591"	14.0-15.0
04240-16	.591 - .630"	15.0-16.0
04240-17	.630 - .669"	16.0-17.0
04240-18	.669 - .709"	17.0-18.0
04240-19	.709 - .748"	18.0-19.0
04240-20	.748 - .787"	19.0-20.0
04240-21	.787 - .827"	20.0-21.0
04240-22	.827 - .866"	21.0-22.0
04240-23	.866 - .906"	22.0-23.0
04240-24	.906 - .945"	23.0-24.0
04240-25	.945 - .984"	24.0-25.0
04240-26	.984 - 1.024"	25.0-26.0

## ER50 COLLETS METRIC

Part No.	Inch Range	Shank
04250-06	.197 - .236"	5.0-6.0
04250-07	.236 - .276"	6.0-7.0
04250-08	.276 - .315"	7.0-8.0
04250-09	.315 - .354"	8.0-9.0
04250-10	.354 - .394"	9.0-10.0
04250-12	.394 - .472"	10.0-12.0
04250-14	.472 - .551"	12.0-14.0
04250-16	.551 - .630"	14.0-16.0
04250-18	.630 - .709"	16.0-18.0
04250-20	.709 - .787"	18.0-20.0
04250-22	.787 - .866"	20.0-22.0
04250-24	.866 - .945"	22.0-24.0
04250-26	.945 - 1.024"	24.0-26.0
04250-28	1.024 - 1.102"	26.0-28.0
04250-30	1.102 - 1.181"	28.0-30.0
04250-32	1.181 - 1.259"	30.0-32.0
04250-34	1.259 - 1.338"	32.0-34.0

# DNA (DEAD NUTS ACCURATE) COLLETS



## FEATURES

- Compatible with ER collet chucks and extensions
- 0.0002" T.I.R. extends tool life
- More rigid and more accurate than ER for small diameter shanks

Use the table for selecting your replacement collets. DNA collets all have unique length and diameter measurements.

### DNA DIMENSIONS

Collet	L	D
DNA 11	.673	.460
DNA 16	.945	.654
DNA 20	1.201	.815
DNA 32	1.571	1.301

## DNA 11 COLLETS & ACCESSORIES

Part No.	Shank Size inch/mm	Collapse Range inch/mm
05952-02	5/64" / 1.5 - 2mm	.059" - .079" / .5mm
05952-03	7/64" / 2.5 - 3mm	.098" - .118" / .5mm
05952-03.5	1/8" / 3 - 3.5mm	.118" - .138" / .5mm
05952-04	5/32" / 3.5 - 4mm	.138" - .157" / .5mm
05952-05	3/16" / 4.5 - 5mm	.177" - .197" / .5mm
05952-06	15/64" / 5.5 - 6mm	.216" - .236" / .5mm
05952-1/8	exact size collet: 1/8"	.105" - .125" / .5mm
05952-3/16	exact size collet: 3/16"	.167" - .187" / .5mm
05952-1/4	exact size collet: 1/4"	.230" - .250" / .5mm
2011.0000	DNA 11 nut M14 x .75"	
04608	DNA 11 collet wrench	
DNA11TWA	DNA 11 torque wrench adapter	

## DNA 16 COLLETS & ACCESSORIES

Part No.	Shank Size inch/mm	Range inch/mm
05954-0.3	.2 - .3mm	.007" - .011" / .10mm
05954-0.4	1/64" / .3 - .4mm	.011" - .015" / .10mm
05954-0.5	.4 - .5mm	.015" - .019" / .10mm
05954-0.6	.5 - .6mm	.019" - .023" / .10mm
05954-0.8	1/32" / .7 - .8mm	.027" - .031" / .10mm
05954-1.0	.9 - 1.0mm	.035" - .039" / .10mm
05954-1.2	3/64" / 1.1 - 1.2mm	.043" - .047" / .10mm
05954-1.25	1.0 - 1.25mm	.039" - .049" / .25mm
05954-1.5	1.25 - 1.5mm	.049" - .059" / .25mm
05954-1.75	1/16" / 1.5 - 1.75mm	.059" - .068" / .25mm
05954-02	5/64" / 1.75 - 2mm	.068" - .078" / .25mm
05954-2.25	2 - 2.25mm	.078" - .088" / .25mm
05954-2.5	3/32" / 2.25 - 2.5mm	.088" - .098" / .25mm
05954-03	2.5 - 3mm	.098" - .118" / .5mm
05954-3.5	1/8" / 3 - 3.5mm	.118" - .138" / .5mm
05954-04	5/32" / 3.5 - 4mm	.137" - .157" / .5mm
05954-4.5	4 - 4.5mm	.157" - .177" / .5mm
05954-05	3/16" / 4 - 5mm	.157" - .197" / 1.0mm
05954-06	7/32" / 5 - 6mm	.196" - .236" / 1.0mm
05954-07	1/4" / 6 - 7mm	.236" - .275" / 1.0mm
05954-08	5/16" / 7 - 8mm	.275" - .314" / 1.0mm
05954-09	11/32" / 8 - 9mm	.314" - .354" / 1.0mm
05954-10	3/8" / 9 - 10mm	.354" - .392" / 1.0mm
05954-1/8	exact size collet: 1/8"	.105" - .125" / .5mm
05954-3/16	exact size collet: 3/16"	.147" - .187" / 1.0mm
05954-1/4	exact size collet: 1/4"	.210" - .25" / 1.0mm
05954-3/8	exact size collet: 3/8"	.335 - .375" / 1.0mm

### HOW IT WORKS

ER Collet: large counterbore leaves shank unsupported

DNA Collet: twice as much metal holding tool shank!

DNA collets hold small tools with greater rigidity and more accuracy (T.I.R.) for greatly improved tool life.



DNA Sealed Nut



DNA 16 Nut

**DNA NUTS FEATURE POWERCOAT FOR 75% MORE HOLDING POWER AND BEST TOOL LIFE.**

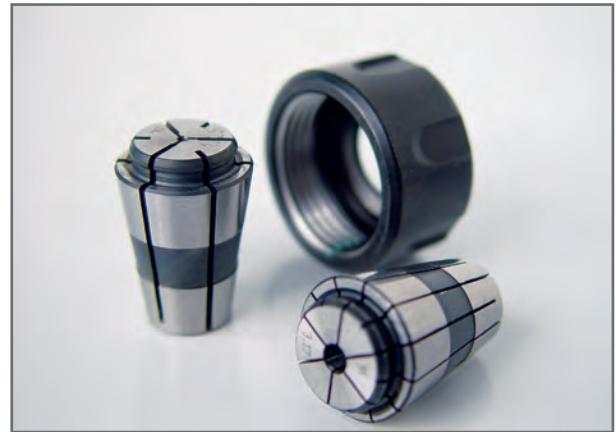

## DNA 16 NUTS & ACCESSORIES

Part No.	Description
2016-2000	DNA16 Mini Nut - M19 x 1.0" x O.D. 25mm
27116	M22 x 1.5 nut, , O.D. 27mm
27116-30	3.0 - 2.5mm sealed nut, O.D. 27mm
27116-40	4.0 - 3.5mm sealed nut, O.D. 27mm
27116-45	4.5 - 4.0mm sealed nut, O.D. 27mm
27116-50	5.0 - 4.5mm sealed nut, O.D. 27mm
27116-55	5.5 - 5mm sealed nut, O.D. 27mm
27116-60	6.0 - 5.5mm sealed nut, O.D. 27mm
27116-65	6.5 - 6mm sealed nut, O.D. 27mm
DNA16W	DNA 16 collet wrench
DNA16TWA	DNA 16 torque wrench adapter
894-22	DNA 16 mini nut wrench

## DNA 20 COLLETS & ACCESSORIES

Part No.	Shank Size inch/mm	Range inch/mm
05956-03	2.5 - 3mm	.098" - .118" / .5mm
05956-3.5	1/8" / 3 - 3.5mm	.118" - .138" / .5mm
05956-04	5/32" / 3.5 - 4mm	.137" - .157" / .5mm
05956-05	3/16" / 4 - 5mm	.157" - .197" / 1.0mm
05956-06	7/32" 5 - 6mm	.197" - .236" / 1.0mm
05956-1/8	exact size collet: 1/8"	.105" - .125" / .5mm
05956-3/16	exact size collet: 3/16"	.147" - .187" / 1.0mm
05956-1/4	exact size collet: 1/4"	.210" - .250" / 1.0mm
05956-3/8	exact size collet: 3/8"	.335" - .375" / 1.0mm
2020.0000	DNA 20 nut, M25 x 1.5" O.D. 32mm	
2020.0000C	DNA 20 coolant nut, uses ER20 rings	
DNA20W	DNA 20 collet wrench	
DNA20TWA	DNA 20 torque wrench adapter	

## DNA 32 COLLETS & ACCESSORIES

Part No.	Shank Size inch/mm	Range inch/mm
05958-03	2.5 - 3mm	.098" - .118" / .5mm
05958-3.5	1/8" / 3 - 3.5mm	.118" - .138" / .5mm
05958-04	5/32" / 3.5 - 4mm	.137" - .157" / .5mm
05958-05	3/16" / 4 - 5mm	.157" - .197" / 1.0mm
05958-06	7/32" 5 - 6mm	.197" - .236" / 1.0mm
05958-1/8	exact size collet: 1/8"	.105" - .125" / .5mm
05958-3/16	exact size collet: 3/16"	.147" - .187" / 1.0mm
05958-1/4	exact size collet: 1/4"	.210" - .250" / 1.0mm
05958-3/8	exact size collet: 3/8"	.335" - .375" / 1.0mm
05958-1/2	exact size collet: 1/2"	.460" - .5" / 1.0mm
05958-3/4	exact size collet: 3/4"	.710" - .75" / 1.0mm
05958-13	exact size collet: 13mm	.472" - .512" / 1.0mm
05958-20	exact size collet: 20mm	.748" - .787" / 1.0mm
1132.0000	DNA 32 nut, M40 x 1.5" O.D. 47.5mm	
1132.0000C	DNA 32 coolant nut, uses ER25 rings	
DNA32W	DNA 32 collet wrench	
DNA32TWA	DNA 32 torque wrench adapter	

## DNA COLLETS VS. ER COLLETS

### PROJECTION COMPARISON

DNA collets provide shorter projection from the collet chuck for better rigidity and when clearance is needed.

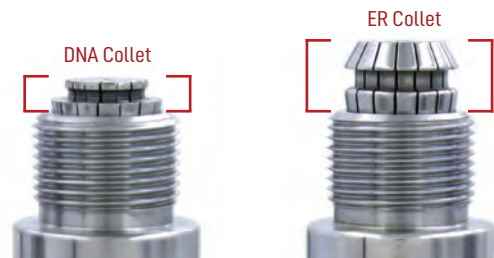

# ER STEEL SEALED COLLETS - INCH



## FEATURES

- Sealed to 2000 PSI
- No plugs to fail
- For best results use with PowerCOAT nut

Designed for use with on-size tools.  
Use with ER, RD, DR, ESX or BR collet chucks.

## DIMENSIONS

Use this table for selecting your replacement collets. ER collets all have unique length and diameter measurements.

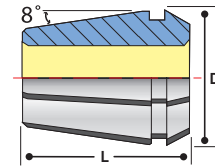

Size	L	D
ER11	18mm (.708")	11.5mm (.45")
ER16	27.5mm (1.08")	17mm (0.67")
ER20	31.5mm (1.24")	21mm (0.83")
ER25	34mm (1.34")	26mm (1.02")
ER32	40mm (1.57")	33mm (1.3")
ER40	46mm (1.81")	41mm (1.61")
ER50	60mm (2.36")	52mm (2.05")

## ER11 INCH

Part No.	Shank
04542-3/32	3/32"
04542-1/8	1/8"
04542-5/32	5/32"
04542-3/16	3/16"
04542-7/32	7/32"
04542-1/4	1/4"

## ER16 INCH

Part No.	Shank
04543-3/32	3/32"
04543-1/8	1/8"
04543-5/32	5/32"
04543-3/16	3/16"
04543-7/32	7/32"
04543-1/4	1/4"
04543-9/32	9/32"
04543-5/16	5/16"
04543-11/32	11/32"
04543-3/8	3/8"
04543-13/32	13/32"

## ER20 INCH

Part No.	Shank
04544-1/8	1/8"
04544-5/32	5/32"
04544-3/16	3/16"
04544-7/32	7/32"
04544-1/4	1/4"
04544-9/32	9/32"
04544-5/16	5/16"
04544-11/32	11/32"
04544-3/8	3/8"
04544-13/32	13/32"
04544-7/16	7/16"
04544-15/32	15/32"
04544-1/2	1/2"

## ER25 INCH

Part No.	Shank
04545-7/32	7/32"
04545-1/4	1/4"
04545-9/32	9/32"
04545-5/16	5/16"
04545-11/32	11/32"
04545-3/8	3/8"
04545-13/32	13/32"
04545-7/16	7/16"
04545-15/32	15/32"
04545-1/2	1/2"
04545-17/32	17/32"
04545-9/16	9/16"
04545-19/32	19/32"
04545-5/8	5/8"

## ER32 INCH

Part No.	Shank
04546-7/32	7/32"
04546-1/4	1/4"
04546-9/32	9/32"
04546-5/16	5/16"
04546-11/32	11/32"
04546-3/8	3/8"
04546-13/32	13/32"
04546-7/16	7/16"
04546-15/32	15/32"
04546-1/2	1/2"
04546-17/32	17/32"
04546-9/16	9/16"
04546-19/32	19/32"
04546-5/8	5/8"
04546-21/32	21/32"
04546-11/16	11/16"
04546-23/32	23/32"
04546-3/4	3/4"

## ER40 INCH

Part No.	Shank
04547-3/8	3/8"
04547-13/32	13/32"
04547-7/16	7/16"
04547-15/32	15/32"
04547-1/2	1/2"
04547-17/32	17/32"
04547-9/16	9/16"
04547-19/32	19/32"
04547-5/8	5/8"
04547-21/32	21/32"
04547-11/16	11/16"
04547-23/32	23/32"
04547-3/4	3/4"
04547-27/32	27/32"
04547-7/8	7/8"
04547-29/32	29/32"
04547-31/32	31/32"
04547-63/64	63/64"
04547-1	1.0"

## ER50 INCH

Part No.	Shank
04548-1/4	1/4"
04548-3/8	3/8"
04548-7/16	7/16"
04548-1/2	1/2"
04548-5/8	5/8"
04548-3/4	3/4"
04548-7/8	7/8"
04548-1	1"
04548-1-1/16	1-1/16"
04548-1-3/16	1-3/16"
04548-1-1/8	1-1/8"
04548-1-1/4	1-1/4"
04548-1-3/8	1-3/8"



## STEEL COLLET SETS INCH

Part No.	Size	Pcs.	Fits Shank Sizes
04543IS	ER16	10	3/32 - 3/8"
04544IS	ER20	12	5/32 - 1/2"
04545IS	ER25	14	7/32 - 5/8"
04546IS	ER32	18	7/32 - 3/4"
04547IS	ER40	15	3/8 - 1.0"
04548IS	ER50	10	1/4" - 1-3/8"



pg. 62



pg. 64



pg. 229



pg. 236



pg. 238

# ER STEEL SEALED COLLETS - METRIC



Designed for use with on-size tools.

Use with ER, RD, DR, ESX or BR collet chucks.

## FEATURES

- Sealed to 2000 PSI
- No plugs to fail
- For best results use with PowerCOAT nut

## DIMENSIONS

Use this table for selecting your replacement collets. ER collets all have unique length and diameter measurements.

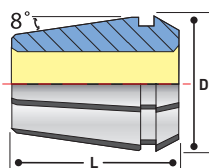

Size	L	D
ER11	18mm (.708")	11.5mm (.45")
ER16	27.5mm (1.08")	17mm (0.67")
ER20	31.5mm (1.24")	21mm (0.83")
ER25	34mm (1.34")	26mm (1.02")
ER32	40mm (1.57")	33mm (1.3")
ER40	46mm (1.81")	41mm (1.61")
ER50	60mm (2.36")	52mm (2.05")

### ER11 METRIC

Part No.	Shank
04542-03	3mm
04542-03.5	3.5mm
04542-04	4mm
04542-04.5	4.5mm
04542-05	5mm
04542-05.5	5.5mm
04542-06	6mm
04542-06.5	6.5mm
04542-07	7mm

### ER16 METRIC

Part No.	Shank
04543-03	3mm
04543-04	4mm
04543-05	5mm
04543-06	6mm
04543-07	7mm
04543-08	8mm
04543-09	9mm
04543-10	10mm

### ER20 METRIC

Part No.	Shank
04544-03	3mm
04544-04	4mm
04544-05	5mm
04544-06	6mm
04544-07	7mm
04544-08	8mm
04544-09	9mm
04544-10	10mm
04544-11	11mm
04544-12	12mm
04544-13	13mm

### ER25 METRIC

Part No.	Shank
04545-03	3mm
04545-04	4mm
04545-05	5mm
04545-06	6mm
04545-07	7mm
04545-08	8mm
04545-09	9mm
04545-10	10mm
04545-11	11mm
04545-12	12mm
04545-13	13mm
04545-14	14mm
04545-15	15mm
04545-16	16mm

### ER32 METRIC

Part No.	Shank
04546-03	3mm
04546-04	4mm
04546-05	5mm
04546-06	6mm
04546-07	7mm
04546-08	8mm
04546-09	9mm
04546-10	10mm
04546-11	11mm
04546-12	12mm
04546-13	13mm
04546-14	14mm
04546-15	15mm
04546-16	16mm
04546-17	17mm
04546-18	18mm
04546-19	19mm
04546-20	20mm

### ER40 METRIC

Part No.	Shank
04547-06	6mm
04547-07	7mm
04547-08	8mm
04547-09	9mm
04547-10	10mm
04547-11	11mm
04547-12	12mm
04547-13	13mm
04547-14	14mm
04547-15	15mm
04547-16	16mm
04547-17	17mm
04547-18	18mm
04547-19	19mm
04547-20	20mm
04547-25	25mm

### ER50 METRIC

Part No.	Shank
04548-10	10mm
04548-12	12mm
04548-14	14mm
04548-20	20mm
04548-22	22mm



## STEEL SEALED COLLET SETS METRIC

Part No.	Size	Pcs.	Fits Shank Sizes
04543MS	ER16	8	3 - 10mm
04544MS	ER20	11	3 - 13mm
04545MS	ER25	14	3 - 16mm
04546MS	ER32	18	3 - 20mm
04547MS	ER40	16	6 - 25mm





# ER STEEL SEALED COLLETS - COOLBLAST



## FEATURES

- CoolBLAST coolant ports direct coolant to the cutting area
- Average 0.0002" T.I.R.
- Pressure rated to 1,400 PSI

## ER16 COOLBLAST INCH

Part No.	Shank
04417-1/8	1/8"
04417-5/32	5/32"
04417-3/16	3/16"
04417-7/32	7/32"
04417-1/4	1/4"
04417-9/32	9/32"
04417-5/16	5/16"

## ER16 COOLBLAST METRIC

Part No.	Shank
04417-03	3mm
04417-04	4mm
04417-05	5mm
04417-06	6mm
04417-07	7mm

## ERS25 COOLBLAST INCH

Part No.	Shank
04426-7/32	7/32"
04426-1/4	1/4"
04426-9/32	9/32"
04426-5/16	5/16"
04426-11/32	11/32"
04426-3/8	3/8"
04426-13/32	13/32"
04426-7/16	7/16"
04426-15/32	15/32"
04426-1/2	1/2"
04426-17/32	17/32"
04426-9/16	9/16"

## ERS25 COOLBLAST METRIC

Part No.	Shank
04426-03	3mm
04426-04	4mm
04426-05	5mm
04426-06	6mm
04426-07	7mm
04426-08	8mm
04426-09	9mm
04426-10	10mm
04426-11	11mm
04426-12	12mm
04426-13	13mm
04426-14	14mm

## ERS20 COOLBLAST INCH

Part No.	Shank
04421-1/8	1/8"
04421-5/32	5/32"
04421-3/16	3/16"
04421-7/32	7/32"
04421-1/4	1/4"
04421-9/32	9/32"
04421-5/16	5/16"
04421-11/32	11/32"
04421-3/8	3/8"

## ERS20 COOLBLAST METRIC

Part No.	Shank
04421-03	3mm
04421-04	4mm
04421-05	5mm
04421-06	6mm
04421-07	7mm
04421-08	8mm
04421-09	9mm

## ERS32 COOLBLAST INCH

Part No.	Shank
04433-7/32	7/32"
04433-1/4	1/4"
04433-9/32	9/32"
04433-5/16	5/16"
04433-11/32	11/32"
04433-3/8	3/8"
04433-13/32	13/32"
04433-7/16	7/16"
04433-15/32	15/32"
04433-1/2	1/2"
04433-17/32	17/32"
04433-9/16	9/16"
04433-19/32	19/32"
04433-5/8	5/8"
04433-21/32	21/32"
04433-11/16	11/16"
04433-23/32	23/32"
04433-3/4	3/4"

## ERS32 COOLBLAST METRIC

Part No.	Shank
04433-03	3mm
04433-04	4mm
04433-05	5mm
04433-06	6mm
04433-07	7mm
04433-08	8mm
04433-09	9mm
04433-10	10mm
04433-11	11mm
04433-12	12mm
04433-13	13mm
04433-14	14mm
04433-15	15mm
04433-16	16mm
04433-17	17mm
04433-18	18mm
04433-19	19mm
04433-20	20mm

## ERS40 COOLBLAST INCH

Part No.	Shank
04441-7/32	7/32"
04441-1/4	1/4"
04441-9/32	9/32"
04441-5/16	5/16"
04441-11/32	11/32"
04441-3/8	3/8"
04441-13/32	13/32"
04441-7/16	7/16"
04441-15/32	15/32"
04441-1/2	1/2"
04441-17/32	17/32"
04441-9/16	9/16"
04441-19/32	19/32"
04441-5/8	5/8"
04441-21/32	21/32"
04441-11/16	11/16"
04441-23/32	23/32"
04441-3/4	3/4"
04441-7/8	7/8"
04441-1	1"

## ERS40 COOLBLAST METRIC

Part No.	Shank
04441-03	3mm
04441-04	4mm
04441-05	5mm
04441-06	6mm
04441-07	7mm
04441-08	8mm
04441-09	9mm
04441-10	10mm
04441-11	11mm
04441-12	12mm
04441-13	13mm
04441-14	14mm
04441-15	15mm
04441-16	16mm
04441-17	17mm
04441-18	18mm
04441-19	19mm
04441-20	20mm
04441-21	21mm
04441-22	22mm
04441-23	23mm
04441-24	24mm
04441-25	25mm
04441-26	26mm



## FEATURES

- For coolant up to 750 PSI
- Collapse range: 0.5mm
- For best results use with PowerCOAT nuts

## COOLANT COLLET SETS

Part No.	Description
08316MS	15 pcs. ER16
08320MS	21 pcs ER20
08325MS	27 pcs ER25
08332-35MS	35 pcs ER32
08340-41MS	41 pcs ER40

## ER32 COOLANT

Part No.	Shank
08332-03.0	3mm
08332-03.5	3.5mm
08332-04.0	4mm
08332-04.5	4.5mm
08332-05.0	5mm
08332-05.5	5.5mm
08332-06.0	6mm
08332-1/4	1/4"
08332-06.5	6.5mm
08332-07.0	7mm
08332-07.5	7.5mm
08332-08.0	8mm
08332-08.5	8.5mm
08332-09.0	9mm
08332-09.5	9.5mm
08332-10.0	10mm
08332-10.5	10.5mm
08332-11.0	11mm
08332-11.5	11.5mm
08332-12.0	12mm
08332-12.5	12.5mm
08332-1/2	1/2"
08332-13.0	13mm
08332-13.5	13.5mm
08332-14.0	14mm
08332-14.5	14.5mm
08332-15.0	15mm
08332-15.5	15.5mm
08332-16.0	16mm
08332-16.5	16.5mm
08332-17.0	17mm
08332-17.5	17.5mm
08332-18.0	18mm
08332-18.5	18.5mm
08332-19	19mm
08332-3/4	3/4"
08332-19.5	19.5mm
08332-20.0	20mm

## ER40 COOLANT

Part No.	Shank
08340-06.0	6mm
08340-1/4	1/4"
08340-06.5	6.5mm
08340-07.0	7mm
08340-07.5	7.5mm
08340-08.0	8mm
08340-08.5	8.5mm
08340-09.0	9mm
08340-09.5	9.5mm
08340-10.0	10mm
08340-10.5	10.5mm
08340-11.0	11mm
08340-11.5	11.5mm
08340-12.0	12mm
08340-12.5	12.5mm
08340-1/2	1/2"
08340-13.0	13mm
08340-13.5	13.5mm
08340-14.0	14mm
08340-14.5	14.5mm
08340-15.0	15mm
08340-15.5	15.5mm
08340-16.0	16mm
08340-16.5	16.5mm
08340-17.0	17mm
08340-17.5	17.5mm
08340-18.0	18mm
08340-18.5	18.5mm
08340-19.0	19mm
08340-3/4	3/4"
08340-19.5	19.5mm
08340-20.0	20mm
08340-20.5	20.5mm
08340-21.0	21mm
08340-21.5	21.5mm
08340-22.0	22mm
08340-22.5	22.5mm
08340-23.0	23mm
08340-23.5	23.5mm
08340-24.0	24mm
08340-24.5	24.5mm
08340-25.0	25mm
08340-25.5	25.5mm
08340-26.0	26mm
08340-1	1" / 25.4mm

## ER16 COOLANT

Part No.	Shank
08316-03.0	3mm
08316-03.5	3.5mm
08316-04.0	4mm
08316-04.5	4.5mm
08316-05.0	5mm
08316-05.5	5.5mm
08316-06.0	6mm
08316-1/4	1/4"
08316-06.5	6.5mm
08316-07.0	7mm
08316-07.5	7.5mm
08316-08.0	8mm
08316-08.5	8.5mm
08316-09.0	9mm
08316-09.5	9.5mm
08316-10.0	10mm

## ER20 COOLANT

Part No.	Shank
08320-03.0	3mm
08320-03.5	3.5mm
08320-04.0	4mm
08320-04.5	4.5mm
08320-05.0	5mm
08320-05.5	5.5mm
08320-06.0	6mm
08320-1/4	1/4"
08320-06.5	6.5mm
08320-07.0	7mm
08320-07.5	7.5mm
08320-08.0	8mm
08320-08.5	8.5mm
08320-09.0	9mm
08320-09.5	9.5mm
08320-10.0	10mm
08320-10.5	10.5mm
08320-11.0	11mm
08320-11.5	11.5mm
08320-12.0	12mm
08320-12.5	12.5mm
08320-1/2	1/2"
08320-13.0	13mm

## ER25 COOLANT

Part No.	Shank
08325-03.0	3mm
08325-03.5	3.5mm
08325-04.0	4mm
08325-04.5	4.5mm
08325-05.0	5mm
08325-05.5	5.5mm
08325-06.0	6mm
08325-1/4	1/4"
08325-06.5	6.5mm
08325-07.0	7mm
08325-07.5	7.5mm
08325-08.0	8mm
08325-08.5	8.5mm
08325-09.0	9mm
08325-09.5	9.5mm
08325-10.0	10mm
08325-10.5	10.5mm
08325-11.0	11mm
08325-11.5	11.5mm
08325-12.0	12mm
08325-12.5	12.5mm
08325-1/2	1/2"
08325-13.0	13mm
08325-13.5	13.5mm
08325-14.0	14mm
08325-14.5	14.5mm
08325-15.0	15mm
08325-15.5	15.5mm
08325-16.0	16mm

# ER RIGID TAP COLLETS - INCH



## FEATURES

- Replaces expensive tap holders
- Reduce tapping clearance requirements
- Special design locks the tap square in slots

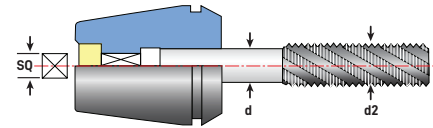

## ER16 RIGID TAP COLLETS INCH

Part No.	d	SQ	Tap Size (d2)
05320-141	.141"	.110"	1/8" or #6
05320-168	.168"	.131"	5/32" or #8
05320-194	.194"	.152"	3/16" or #10
05320-220	.220"	.165"	7/32" or #12
05320-255	.255"	.191"	1/4"
05320-318	.318"	.238"	5/16"
05320-323	.323"	.242"	7/16"
05320-367	.367"	.275"	1/2"
05320-381	.381"	.286"	3/8"

## ER20 RIGID TAP COLLETS INCH

Part No.	d	SQ	Tap Size (d2)
05410-141	.141"	.110"	1/8" or #6
05410-168	.168"	.131"	5/32" or #8
05410-194	.194"	.152"	3/16" or #10
05410-220	.220"	.165"	7/32" or #12
05410-255	.255"	.191"	1/4"
05410-318	.318"	.238"	5/16"
05410-323	.323"	.242"	7/16"
05410-367	.367"	.275"	1/2"
05410-381	.381"	.286"	3/8"

## RIGID TAP COLLET SETS INCH

Part No.	Description
05320-5(SET)	5 piece ER16 set
05320-9(SET)	9 piece ER16 set
05410-9(SET)	9 piece ER20 set
05510-11(SET)	11 piece ER25 set
05570-16(SET)	16 piece ER32 set
05710-21(SET)	21 piece ER40 set

## ER25 RIGID TAP COLLETS INCH

Part No.	d	SQ	Tap Size (d2)
05510-141	.141"	.110"	1/8" or #6
05510-168	.168"	.131"	5/32" or #8
05510-194	.194"	.152"	3/16" or #10
05510-220	.220"	.165"	7/32" or #12
05510-255	.255"	.191"	1/4"
05510-318	.318"	.238"	5/16"
05510-323	.323"	.242"	7/16"
05510-367	.367"	.275"	1/2"
05510-381	.381"	.286"	3/8"
05510-429	.429"	.322"	9/16"
05510-437	.437"	.328"	1/8" NPT
05510-480	.480"	.360"	5/8"
05510-542	.542"	.406"	11/16"

## ER32 RIGID TAP COLLETS INCH

Part No.	d	SQ	Tap Size (d2)
05570-141	.141"	.110"	1/8" or #6
05570-168	.168"	.131"	5/32" or #8
05570-194	.194"	.152"	3/16" or #10
05570-220	.220"	.165"	7/32" or #12
05570-255	.255"	.191"	1/4"
05570-318	.318"	.238"	5/16"
05570-323	.323"	.242"	7/16"
05570-367	.367"	.275"	1/2"
05570-381	.381"	.286"	3/8"
05570-429	.429"	.322"	9/16"
05570-437	.437"	.328"	1/8" NPT
05570-480	.480"	.360"	5/8"
05570-542	.542"	.406"	11/16"
05570-562	.562"	.421"	1/4" NPT
05570-590	.590"	.442"	3/4"
05570-652	.652"	.489"	13/16"

## ER40 RIGID TAP COLLETS INCH

Part No.	d	SQ	Tap Size (d2)
05710-141	.141"	.110"	1/8" or #6
05710-168	.168"	.131"	5/32" or #8
05710-194	.194"	.152"	3/16" or #10
05710-220	.220"	.165"	7/32" or #12
05710-255	.255"	.191"	1/4"
05710-318	.318"	.238"	5/16"
05710-323	.323"	.242"	7/16"
05710-367	.367"	.275"	1/2"
05710-381	.381"	.286"	3/8"
05710-429	.429"	.322"	9/16"
05710-437	.437"	.328"	1/8" NPT
05710-480	.480"	.360"	5/8"
05710-542	.542"	.406"	11/16"
05710-562	.562"	.421"	1/4" NPT
05710-590	.590"	.442"	3/4"
05710-652	.652"	.489"	13/16"
05710-687	.687"	.515"	1/2" NPT
05710-697	.697"	.523"	7/8"
05710-700	.700"	.531"	3/8" NPT
05710-760	.760"	.570"	15/16"
05710-800	.800"	.600"	1"



pg. 62



pg. 64



pg. 229



pg. 236



pg. 238

# ER RIGID TAP COLLETS - METRIC



## FEATURES

- Replaces expensive tap holders
- Reduce tap clearance requirements
- Special design locks the tap square in slots



## ER16 RIGID TAP COLLETS METRIC

Part No.	d	SQ	Tap Size (d2)
05326	2.8	2.1	M4
05330	3.5	2.7	M3
05336	4.5	3.4	M4
05342	6	4.9	M5/M6
05350	8	6.2	M8
05352	8.5	6.5	M12
05354	9	7	M12
05356	10	8	M10
05371	6	4.5	M6
05385	6.2	5	M8

## ER20 RIGID TAP COLLETS METRIC

Part No.	d	SQ	Tap Size (d2)
05428	4.5	3.4	M4
05434	6	4.9	M5/M6
05442	8	6.2	M8
05446	9	7	M12
05448	10	8	M10
05456	12	9	M16

## ER25 RIGID TAP COLLETS METRIC

Part No.	d	SQ	Tap Size (d2)
05526	4.5	3.4	M4
05534	6	4.9	M5/M6
05540	7	5.5	M10
05542	8	6.2	M8
05548	9	7	M12
05550	10	8	M10
05550	10	8	M10
05554	11	9	M14
05558	12	9	M16
05560	12.5	10	M16
05562	13	10	M17
05564	14	11	M18/M20
05566	15	12	M20
05568	16	12	M20/M22

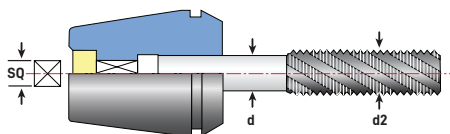

## ER32 RIGID TAP COLLETS METRIC

Part No.	d	SQ	Tap Size (d2)
05572	2.25	1.8	M3
05574	2.5	2	M3.5
05576	2.8	2.1	M4
05578	3.14	2.5	M3/M4
05580	3.5	2.7	M3/M5
05582	3.55	2.8	M3.5/M4.5
05584	4	3	M3/M5
05586	4.5	3.4	M4/M6
05588	5	5	M4/M5
05590	5.5	4.5	M5/M5.5
05592	6	4.5	M5/M8
05594	6.2	5	M7/M8
05596	6.3	5	M6/M8
05598-M9	7	5.5	M9/M10
05600	8	6	M8/M11
05602	8.5	6.5	M12
05604	9	7	M12
05606	10	8	M10
05608	10.5	8	M14
05610	11	9	M14
05612	11.2	9	M14
05614	12	9	M16
05616	12.5	10	M16
05618	13	10	M17
05620	14	11	M18/M20
05622	15	12	M20
05624	16	12	M20/M22
05626	17	13	M22
05628	18	14	M22/M24
05630	19	15	M24/M25
05632	20	15	M26/M27

## RIGID TAP COLLET SET METRIC

Part No.	Description
05699-11SET	05699-11 Metric Set

## ER40 RIGID TAP COLLETS METRIC

Part No.	d	SQ	Tap Size (d2)
05712	2.24	1.88	M3
05714	2.5	1	M3.5
05716	2.8	2.1	M4
05718	3.15	2.5	M3/M4
05720	3.5	2.7	M3/M5
05722	3.55	2.8	M3.5/M4.5
05724	4	3	M3/M5
05726	4.5	3.4	M4/M6
05728	5	4	M4/M5
05730	4.5	4.5	M5/M5.5
05732	6	4.5	M5/M8
05734	6.2	5	M7/M8
05736	6.3	5	M6/M8
05738	7	5.5	M10
05740	8	6	M8/M11
05742	8.5	6.5	M12
05744	9	7	M12
05746	10	8	M10
05748	10.5	8	M14
05750	11	9	M14
05752	11.2	9	M14
05754	12	9	M16
05756	12.5	10	M16
05758	13	10	M17
05760	14	11	M18/M20
05762	15	12	M20
05764	16	12	M20/M22
05766	17	13	M22
05768	18	14	M22/M24
05770	19	14	M24/M25
05772	20	15	M26/M27



# ER STEEL SEALED RIGID TAP COLLETS - INCH



## FEATURES

- For coolant thru taps
- Special design locks the tap square in slots
- For best results use with PowerCOAT nuts

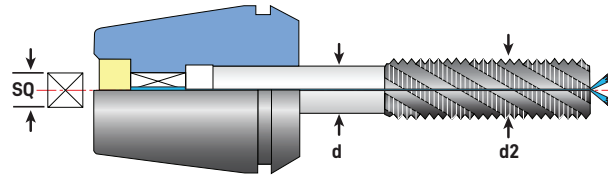

## ER16 STEEL SEALED RIGID TAP COLLETS INCH

Part No.	d	SQ	Tap Size (d2)
254.16-168	.168"	.131"	5/32" or #8
254.16-194	.194"	.152"	3/16" or #10
254.16-220	.220"	.165"	7/32" or #12
254.16-255	.255"	.191"	1/4"
254.16-318	.318"	.238"	5/16"
254.16-323	.323"	.242"	7/16"
254.16-367	.367"	.275"	1/2"
254.16-381	.381"	.286"	3/8"

## ER20 STEEL SEALED RIGID TAP COLLETS INCH

Part No.	d	SQ	Tap Size (d2)
254.20-168	.168"	.131"	5/32" or #8
254.20-194	.194"	.152"	3/16" or #10
254.20-220	.220"	.165"	7/32" or #12
254.20-255	.255"	.191"	1/4"
254.20-318	.318"	.238"	5/16"
254.20-323	.323"	.242"	7/16"
254.20-367	.367"	.275"	1/2"
254.20-381	.381"	.286"	3/8"

## ER25 STEEL SEALED RIGID TAP COLLETS INCH

Part No.	d	SQ	Tap Size (d2)
254.25-168	.168"	.131"	5/32" or #8
254.25-194	.194"	.152"	3/16" or #10
254.25-220	.220"	.165"	7/32" or #12
254.25-255	.255"	.191"	1/4"
254.25-318	.318"	.238"	5/16"
254.25-323	.323"	.242"	7/16"
254.25-367	.367"	.275"	1/2"
254.25-381	.381"	.286"	3/8"
254.25-429	.429"	.322"	9/16"
254.25-437	.437"	.328"	1/8" NPT
254.25-480	.480"	.360"	5/8"
254.25-542	.542"	.406"	11/16"

## ER32 STEEL SEALED RIGID TAP COLLETS INCH

Part No.	d	SQ	Tap Size (d2)
254.32-168	.168"	.131"	5/32" or #8
254.32-194	.194"	.152"	3/16" or #10
254.32-220	.220"	.165"	7/32" or #12
254.32-255	.255"	.191"	1/4"
254.32-318	.318"	.238"	5/16"
254.32-323	.323"	.242"	7/16"
254.32-367	.367"	.275"	1/2"
254.32-381	.381"	.286"	3/8"
254.32-429	.429"	.322"	9/16"
254.32-437	.437"	.328"	1/8" NPT
254.32-480	.480"	.360"	5/8"
254.32-542	.542"	.406"	11/16"
254.32-562	.562"	.421"	1/4" NPT
254.32-590	.590"	.442"	3/4"
254.32-652	.652"	.489"	13/16"

## ER40 STEEL SEALED RIGID TAP COLLETS INCH

Part No.	d	SQ	Tap Size (d2)
254.40-168	.168"	.131"	5/32" or #8
254.40-194	.194"	.152"	3/16" or #10
254.40-220	.220"	.165"	7/32" or #12
254.40-255	.255"	.191"	1/4"
254.40-318	.318"	.238"	5/16"
254.40-323	.323"	.242"	7/16"
254.40-367	.367"	.275"	1/2"
254.40-381	.381"	.286"	3/8"
254.40-429	.429"	.322"	9/16"
254.40-437	.437"	.328"	1/8" NPT
254.40-480	.480"	.360"	5/8"
254.40-542	.542"	.406"	11/16"
254.40-562	.562"	.421"	1/4" NPT
254.40-590	.590"	.442"	3/4"
254.40-652	.652"	.489"	13/16"
254.40-687	.687"	.515"	1/2" NPT
254.40-697	.697"	.523"	7/8"
254.40-700	.700"	.531"	3/8" NPT
254.40-760	.760"	.570"	15/16"
254.40-800	.800"	.600"	1"





pg. 62



pg. 64



pg. 229



pg. 236



pg. 238

# ER STEEL SEALED RIGID TAP COLLETS - METRIC

## ER16 STEEL SEALED RIGID TAP COLLETS METRIC

Part No.	d	SQ	Tap Size (d2)
254.16-6	6	4.5	M6
254.16-6DIN	6	4.9	M5/M6
254.16-6.2	6.2	5	M8
254.16-8DIN	8	6.2	M8
254.16-8.5	8.5	6.5	M12
254.16-9	9	7	M12
254.16-10	10	8	M10

## ER32 STEEL SEALED RIGID TAP COLLETS METRIC

Part No.	d	SQ	Tap Size (d2)
254.32-6	6	4.5	M6
254.32-6.2	6.2	5	M7/M8
254.32-6.3	6.3	5	M6/M8
254.32-6DIN	6	4.9	M6
254.32-7	7	5.5	M9/M10
254.32-8	8	6	M11
254.32-8DIN	8	6.2	M8
254.32-8.5	8.5	6.5	M12
254.32-9	9	7	M12
254.32-10	10	8	M10
254.32-10.5	10.5	8	M14/M15
254.32-11	11	9	M14
254.32-11.2	11.2	9	M14
254.32-12	12	9	M16
254.32-12.5	12.5	10	M16
254.32-13	13	10	M17
254.32-14	14	11	M18
254.32-15	15	12	M20
254.32-16	16	12	M20
254.32-17	17	13	M22
254.32-18	18	14	M24
254.32-19	19	15	M24/M25
254.32-20	20	15	M26/M27

## ER20 STEEL SEALED RIGID TAP COLLETS METRIC

Part No.	d	SQ	Tap Size (d2)
254.20-4.5	4.5	3.4	M4
254.20-6	6	4.9	M5/M6
254.20-8	8	6.2	M8
254.20-9	9	7	M12
254.20-10	10	8	M10
254.20-12	12	9	M16

## ER40 STEEL SEALED RIGID TAP COLLETS METRIC

Part No.	d	SQ	Tap Size (d2)
254.40-6	6	4.5	M6
254.40-6.2	6.2	5	M7/M8
254.40-6.3	6.3	5	M6/M8
254.40-7	7	5.5	M9/M10
254.40-8	8	6	M11
254.40-8.5	8.5	6.5	M12
254.40-9	9	7	M12
254.40-10	10	8	M10
254.40-10.5	10.5	8	M14/M15
254.40-11	11	9	M14
254.40-11.2	11.2	9	M14
254.40-12	12	9	M16
254.40-12.5	12.5	10	M16
254.40-13	13	10	M17
254.40-14	14	11	M18
254.40-15	15	12	M20
254.40-16	16	12	M20
254.40-17	17	13	M22
254.40-18	18	14	M24
254.40-19	19	15	M24/M25
254.40-20	20	15	M26/M27

## ER25 STEEL SEALED RIGID TAP COLLETS METRIC

Part No.	d	SQ	Tap Size (d2)
254.25-4.5	4.5	3.4	M4
254.25-6	6	4.9	M5/M6
254.25-7	7	5.5	M10
254.25-8	8	6.2	M8
254.25-9	9	7	M12
254.25-10	10	8	M10
254.25-10D	10	8	M10
254.25-11	11	9	M14
254.25-12	12	9	M16
254.25-12.5	12.5	10	M16
254.25-13	13	10	M17
254.25-14	14	11	M18/M20
254.25-15	15	12	M20
254.25-16	16	12	M20/M22

# ER QUICK-CHANGE RIGID TAP COLLETS



## FEATURES

- Quick-Change taps in seconds
- Replaces expensive tap holders
- Locking feature prevents spinning the tap
- Reduce tapping clearance requirements

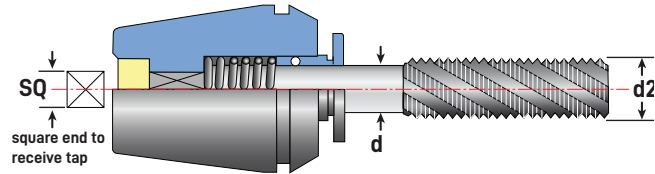

For best tapping performance use with Techniks PowerCOAT nut for highest holding power and accuracy. See page 62.

## COLLET SETS

Part No.	Description
05802-4IS	4 piece ER16 collet set
05804-8IS	8 piece ER20 collet set
0580611IS	11 piece ER25 collet set
05808-15IS	15 piece ER32 collet set

## ER16 QUICK-CHANGE RIGID TAP

Part No.	d	SQ	Tap Size (d2)
05802-168	.168"	.131"	5/32" or #8
05802-194	.194"	.152"	3/16" or #10
05802-220	.220"	.165"	7/32" or #12
05802-255	.255"	.191"	1/4"

## ER20 QUICK-CHANGE RIGID TAP

Part No.	d	SQ	Tap Size (d2)
05804-168	.168"	.131"	5/32" or #8
05804-194	.194"	.152"	3/16" or #10
05804-220	.220"	.165"	7/32" or #12
05804-255	.255"	.191"	1/4"
05804-318	.318"	.238"	5/16"
05804-323	.323"	.242"	7/16"
05804-367	.367"	.275"	1/2"
05804-381	.381"	.286"	3/8"

## ER25 QUICK-CHANGE RIGID TAP

Part No.	d	SQ	Tap Size (d2)
05806-168	.168"	.131"	5/32" or #8
05806-194	.194"	.152"	3/16" or #10
05806-220	.220"	.165"	7/32" or #12
05806-255	.255"	.191"	1/4"
05806-318	.318"	.238"	5/16"
05806-323	.323"	.242"	7/16"
05806-367	.367"	.275"	1/2"
05806-381	.381"	.286"	3/8"
05806-429	.429"	.322"	9/16"
05806-437	.437"	.328"	1/8" NPT
05806-480	.480"	.360"	5/8"

## ER32 QUICK-CHANGE RIGID TAP

Part No.	d	SQ	Tap Size (d2)
05808-168	.168"	.131"	5/32" or #8
05808-194	.194"	.152"	3/16" or #10
05808-220	.220"	.165"	7/32" or #12
05808-255	.255"	.191"	1/4"
05808-318	.318"	.238"	5/16"
05808-323	.323"	.242"	7/16"
05808-367	.367"	.275"	1/2"
05808-381	.381"	.286"	3/8"
05808-429	.429"	.322"	9/16"
05808-437	.437"	.328"	1/8" NPT
05808-480	.480"	.360"	5/8"
05808-542	.542"	.406"	11/16"
05808-562	.562"	.421"	1/4" NPT
05808-590	.590"	.442"	3/4"
05808-652	.652"	.489"	13/16"



## FEATURES

- Axial compensation prevents breaking taps
- Replaces expensive tapping heads
- Locking feature prevents spinning the tap
- Reduce tapping clearance requirements

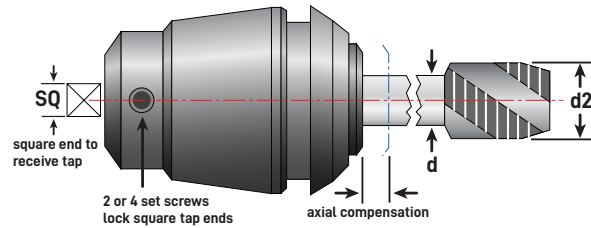

Simply program the machine 5% behind the recommended pitch feed of the tap to engage the floating feature. Return out of the tapped hole at 100%. For best performance use with Techniks PowerCOAT nut.

## FT COLLET SETS

Part No.	Description
05916IS	4 piece FT-116 collet set
05920IS	5 piece FT-120 collet set
05925IS	9 piece FT-125 collet set
05932IS	11 piece FT-132 collet set

## FT-116 FLOATING TAP COLLETS

Part No.	d	SQ	Size (d2)
05916-141	.141"	.110"	1/8" or #6
05916-168	.168"	.131"	5/32" or #8
05916-194	.194"	.152"	3/16" or #10
05916-220	.220"	.165"	7/32" or #12

axial compensation = 7mm

## FT-120 FLOATING TAP COLLETS

Part No.	d	SQ	Size (d2)
05920-141	.141"	.110"	1/8" or #6
05920-168	.168"	.131"	5/32" or #8
05920-194	.194"	.152"	3/16" or #10
05920-220	.220"	.165"	7/32" or #12
05920-255	.255"	.191"	1/4"

axial compensation = 7mm

## FT-125 FLOATING TAP COLLETS

Part No.	d	SQ	Size (d2)
05925-141	.141"	.110"	1/8" or #6
05925-168	.168"	.131"	5/32" or #8
05925-194	.194"	.152"	3/16" or #10
05925-220	.220"	.165"	7/32" or #12
05925-255	.255"	.191"	1/4"
05925-318	.318"	.238"	5/16"
05925-323	.323"	.242"	7/16"
05925-367	.367"	.275"	1/2"
05925-381	.381"	.286"	3/8"

axial compensation = 8mm

## FT-132 FLOATING TAP COLLETS

Part No.	d	SQ	Size (d2)
05932-168	.168"	.131"	5/32" or #8
05932-194	.194"	.152"	3/16" or #10
05932-220	.220"	.165"	7/32" or #12
05932-255	.255"	.191"	1/4"
05932-318	.318"	.238"	5/16"
05932-323	.323"	.242"	7/16"
05932-367	.367"	.275"	1/2"
05932-381	.381"	.286"	3/8"
05932-429	.429"	.322"	9/16"
05932-437	.437"	.328"	1/8" NPT
05932-480	.480"	.360"	5/8"

axial compensation = 10mm



## FEATURES

- "On-Size" collets
- Precision ground and polished
- Each collet individually inspected for quality

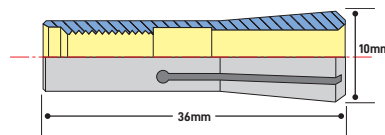

NOTE: TIGHTEN TO 9 FT/LBS

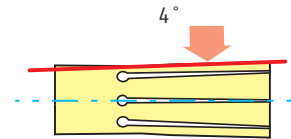

## SLIMFIT COLLET SET

Part No.	Description
18851-12IMS	SlimFIT 12 piece set

Convenient collet set provides the collets you need and the wooden tray prevents damage to collets.

### Set includes 12 collets:

INCH: 7/64", 1/8", 9/64", 11/64"

3/16", 13/64", 15/64", 1/4"

METRIC: 3mm, 4mm, 5mm, 6mm

## SLIMFIT COLLETS INCH

Part No.	Description
18851-3/32	SlimFIT 6 - 3/32" collet
18851-7/64	SlimFIT 6 - 7/64" collet
18851-1/8	SlimFIT 6 - 1/8" collet
18851-9/64	SlimFIT 6 - 9/64" collet
18851-5/32	SlimFIT 6 - 5/32" collet
18851-11/64	SlimFIT 6 - 11/64" collet
18851-3/16	SlimFIT 6 - 3/16" collet
18851-13/64	SlimFIT 6 - 13/64" collet
18851-7/32	SlimFIT 6 - 7/32" collet
18851-15/64	SlimFIT 6 - 15/64" collet
18851-1/4	SlimFIT 6 - 1/4" collet

## SLIMFIT COLLETS METRIC

Part No.	Description
18851-03	SlimFIT 6 - 3mm collet
18851-04	SlimFIT 6 - 4mm collet
18851-05	SlimFIT 6 - 5mm collet
18851-05.5	SlimFIT 6 - 5.5mm collet
18851-06	SlimFIT 6 - 6mm collet

## WHY SLIMFIT OUT-PERFORMS ER COLLET SYSTEMS

SlimFIT collets are longer overall than ER collets and feature a 4° taper, delivering better engagement between collet and tool shank, resulting in better accuracy and balance than ER systems.

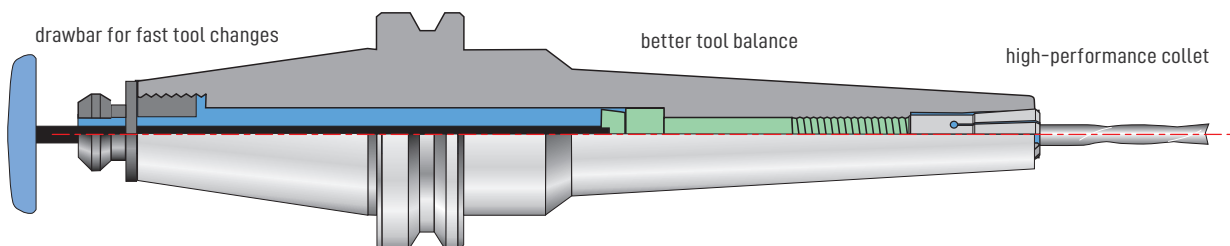



pg. 62



pg. 64



pg. 229



pg. 236



pg. 238

# COLLET STORAGE TRAYS



## FEATURES

- Prevent accidental damage to collets
- Keep collets organized and ready to use
- Exact fit for all your collets



## ER COLLET STORAGE TRAYS

Part No.	Description
04282	ER8 wood tray - 9 pcs.
04284	ER11 wood tray - 13 pcs.
04286	ER16 wood tray - 10 pcs.
04286-12	ER16 wood tray - 12 pcs.
04288	ER20 wood tray - 12 pcs.
04290	ER25 wood tray - 16 pcs.
04292	ER32 wood tray - 18 pcs.
04292-22	ER32 wood tray - 22 pcs.
04294	ER40 wood tray - 24 pcs.
04294-13	ER40 wood tray - 13 pcs.
04296	ER50 wood tray - 12 pcs.

## DA COLLET STORAGE TRAYS

Part No.	Description
04448	DA100 wood tray - 33 pcs.
04449	DA100 wood tray - 8 pcs.
04450	DA100 wood tray - 15 pcs.
04451	DA100 wood tray - 21 pcs.
04452	DA100 wood tray - 29 pcs.
04453	DA180 wood tray - 9 pcs.
04454	DA180 wood tray - 17 pcs.
04455	DA180 wood tray - 21 pcs.
04456	DA180 wood tray - 33 pcs.
04457	DA180 wood tray - 41 pcs.
04459	DA200 wood tray - 9 pcs.
04460	DA200 wood tray - 21 pcs.
04461	DA200 wood tray - 17 pcs.
04462	DA300 wood tray - 7 pcs.
04464	DA300 wood tray - 14 pcs.

## TG COLLET STORAGE TRAYS

Part No.	Description
04466	TG75 wood tray - 11 pcs.
04468	TG75 wood tray - 22 pcs.
04470	TG75 wood tray - 43 pcs.
04472	TG100 wood tray - 15 pcs.
04474	TG100 wood tray - 21 pcs.
04476	TG100 wood tray - 30 pcs.
04478	TG100 wood tray - 41 pcs.
04480	TG100 wood tray - 59 pcs.
04482	TG150 wood tray - 17 pcs.
04484	TG150 wood tray - 33 pcs.
04486	TG150 wood tray - 65 pcs.



# ER POWERCOAT NUTS AND COOLANT NUTS



## FEATURES

- Balanced to 25,000 RPM
- Increases holding power by 75%
- Better rigidity and less T.I.R. (runout)

For best performance use a torque wrench and tighten nut to proper torque specification. Snap collet into nut before assembly.

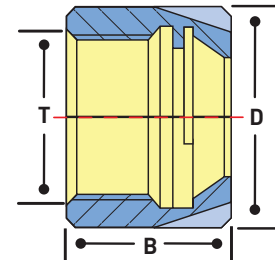

## POWERCOAT ER COLLET NUTS

Part No.	Description	D	B	T	Wrench	Torque Specs.
41111	ER11 PowerCOAT hex nut	19mm	12mm	M14 x 0.75	04608	17 ft./lbs.
41116	ER16 PowerCOAT hex nut	27.5mm	18mm	M22 x 1.5	04609	42 ft./lbs.
41120	ER20 PowerCOAT hex nut	34mm	19mm	M25 x 1.5	04610	59 ft./lbs.
41916	ER16 PowerCOAT slot nut	32mm	18mm	M22 x 1.5	04613	42 ft./lbs.
41920	ER20 PowerCOAT slot nut	35mm	19.5mm	M25 x 1.5	04614	59 ft./lbs.
41925	ER25 PowerCOAT slot nut	42mm	21mm	M32 x 1.5	04615	77 ft./lbs.
41925-L	ER25 PowerCOAT slot nut L	42mm	21mm	M32 x 1.5	04615	77 ft./lbs.
41932	ER32 PowerCOAT slot nut	50mm	23mm	M40 x 1.5	04616	100 ft./lbs.
41940	ER40 PowerCOAT slot nut	63mm	26mm	M50 x 1.5	04617	130 ft./lbs.
41950	ER50 PowerCOAT slot nut	78mm	35mm	M64 x 2.0	04618	130 ft./lbs.

L = Left threaded

## POWERCOAT ULTRA HIGH-SPEED ER NUTS **BALANCED UP TO 70,000 RPM**

Part No.	Description	D	B	T	Wrench	Torque Specs.
46111	ER11 high speed hex nut	19mm	11.8mm	M14 x 0.75	04608	17 ft./lbs.
46116	ER16 high speed slot nut	27.5mm	18.0mm	M22 x 1.5	04613	42 ft./lbs.
46120	ER20 high speed slot nut	35mm	19.5mm	M25 x 1.5	04614	59 ft./lbs.
46125	ER25 high speed slot nut	42mm	20.5mm	M32 x 1.5	04615	77 ft./lbs.
46132	ER32 high speed slot nut	50mm	23.0mm	M40 x 1.5	04616	100 ft./lbs.
46140	ER40 high speed slot nut	63mm	26.0mm	M50 x 1.5	04617	130 ft./lbs.

## POWERCOAT ER COOLANT NUTS **SEALS UP TO 1,500 P.S.I.**

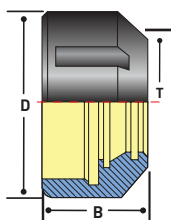

Part No.	Description	D	B	T	Wrench	Torque Specs.
41616	ER16 coolant slot nut	32	22.5	M22x1.5	04613	42 ft./lbs.
41620	ER20 coolant slot nut	35	24	M25x1.5	04614	59 ft./lbs.
41625	ER25 coolant slot nut	42	25	M32x1.5	04615	77 ft./lbs.
41632	ER32 coolant slot nut	50	27.5	M40x1.5	04616	100 ft./lbs.
41640	ER40 coolant slot nut	63	30.7	M50x1.5	04617	130 ft./lbs.



pg. 62



pg. 64



pg. 229



pg. 236



pg. 238

# ER POWERCOAT ER MINI NUTS



## FEATURES

- Increases holding power by 75%
- High speed nuts balanced to 25,000 RPM
- For minimum nose O.D. applications

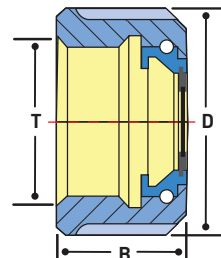

## ER POWERCOAT HIGH SPEED MINI NUTS **BALANCED TO 25,000 RPM AT G2.5**

Part No.	Description	D	B	T	Wrench	Torque Specs
33108	ER8 high speed mini nut	12mm	11mm	M10 x 0.75	04620	10 ft./lbs.
33111	ER11 high speed mini nut	16mm	12mm	M13 x 0.75	04621	12 ft./lbs.
53116	ER16 high speed mini nut	22mm	18mm	M19 x 1.0	04622	20 ft./lbs.
33120	ER20 high speed mini nut	28mm	19.5mm	M24 x 1.0	04623	22 ft./lbs.
33125	ER25 high speed mini nut	35mm	21mm	M30 x 1.0	04624	28 ft./lbs.
33125-L	ER25 high speed left-hand mini nut	35mm	21mm	M30 x 1.0	04624	38 ft./lbs.

## ER POWERCOAT MINI NUTS **BALANCED TO 10,000 RPM AT G2.5**

Part No.	Description	D	B	T	Wrench	Torque Specs.
23108	ER8 mini nut	12mm	11mm	M10 x 0.75	04620	10 ft./lbs.
23111	ER11 mini nut	16mm	12mm	M13 x 0.75	04621	12 ft./lbs.
23116	ER16 mini nut	22mm	18mm	M19 x 1.0	04622	20 ft./lbs.
23120	ER20 mini nut	28mm	19.5mm	M24 x 1.0	04623	22 ft./lbs.
23125	ER25 mini nut	35mm	21mm	M30 x 1.0	04624	28 ft./lbs.



Coolant Style Mini nut  
uses ER coolant rings



## ER POWERCOAT MINI COOLANT NUTS **BALANCED TO 10,000 RPM AT G2.5**

Part No.	Description	Ring	D	B	T	Wrench	Torque Specs.
23616	ER16 mini coolant nut	ER16	22mm	24mm	M19 x 1.0	04622	20 ft./lbs.
23620	ER20 mini coolant nut	ER20	28mm	24mm	M24 x 1.0	04623	22 ft./lbs.
23625	ER25 mini coolant nut	ER25	35mm	26.5mm	M30 x 1.0	04624	28 ft./lbs.



# BLACK GOLD ER COOLANT RINGS



Snap ring into nut before ER collet

## FEATURES

- Seals up to 1,500 P.S.I.
- Use with ER collets
- Use with PowerCOAT coolant nuts



PowerCOAT coolant nuts pg. 62.

NOTE: Remove o-ring for coolant surround tool applications using non-coolant cutting tools.

## ER16 COOLANT RINGS

Part No.	Shank mm	Shank inch
08516-03.5	3.5 – 3.0mm	1/8"
08516-04.0	4.0 – 3.5mm	5/32"
08516-04.5	4.5 – 4.0mm	11/64"
08516-05.0	5.0 – 4.5mm	3/16"
08516-05.5	5.5 – 5.0mm	13/64"
08516-06.0	6.0 – 5.5mm	7/32"
08516-06.5	6.5 – 6.0mm	1/4"
08516-07.0	7.0 – 6.5mm	17/64"
08516-07.5	7.5 – 7.0mm	9/32"
08516-08.0	8.0 – 7.5mm	5/16"
08516-08.5	8.5 – 8.0mm	21/64"
08516-09.0	9.0 – 8.5mm	11/32"
08516-09.5	9.5 – 9.0mm	3/8"
08516-10.0	10.0 – 9.5mm	25/64"

## ER20 COOLANT RINGS

Part No.	Shank mm	Shank inch
08520-03.5	3.5 – 3.0mm	1/8"
08520-04.0	4.0 – 3.5mm	5/32"
08520-04.5	4.5 – 4.0mm	11/64"
08520-05.0	5.0 – 4.5mm	3/16"
08520-05.5	5.5 – 5.0mm	13/64"
08520-06.0	6.0 – 5.5mm	7/32"
08520-06.5	6.5 – 6.0mm	1/4"
08520-07.0	7.0 – 6.5mm	17/64"
08520-07.5	7.5 – 7.0mm	9/32"
08520-08.0	8.0 – 7.5mm	5/16"
08520-08.5	8.5 – 8.0mm	21/64"
08520-09.0	9.0 – 8.5mm	11/32"
08520-09.5	9.5 – 9.0mm	3/8"
08520-10.0	10.0 – 9.5mm	25/64"
08520-10.5	10.5 – 10.0mm	13/32"
08520-11.0	11.0 – 10.5mm	27/64"
08520-11.5	11.5 – 11.0mm	7/16"
08520-12.0	12.0 – 11.5mm	15/32"
08520-12.5	12.5 – 12.0mm	31/64"
08520-13.0	13.0 – 12.5mm	1/2"

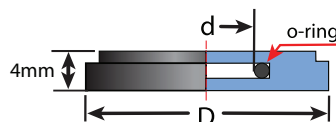

Dimensions	D
ER16	12.9 mm
ER20	15.9 mm
ER25	21 mm
ER32	26.95 mm
ER40	33.3 mm

## ER25 COOLANT RINGS

Part No.	Shank mm	Shank inch
08525-03.5	3.5 – 3.0mm	1/8"
08525-04.0	4.0 – 3.5mm	5/32"
08525-04.5	4.5 – 4.0mm	11/64"
08525-05.0	5.0 – 4.5mm	3/16"
08525-05.5	5.5 – 5.0mm	13/64"
08525-06.0	6.0 – 5.5mm	7/32"
08525-06.5	6.5 – 6.0mm	1/4"
08525-07.0	7.0 – 6.5mm	17/64"
08525-07.5	7.5 – 7.0mm	9/32"
08525-08.0	8.0 – 7.5mm	5/16"
08525-08.5	8.5 – 8.0mm	21/64"
08525-09.0	9.0 – 8.5mm	11/32"
08525-09.5	9.5 – 9.0mm	3/8"
08525-10.0	10.0 – 9.5mm	25/64"
08525-10.5	10.5 – 10.0mm	13/32"
08525-11.0	11.0 – 10.5mm	27/64"
08525-11.5	11.5 – 11.0mm	7/16"
08525-12.0	12.0 – 11.5mm	15/32"
08525-12.5	12.5 – 12.0mm	31/64"
08525-13.0	13.0 – 12.5mm	1/2"
08525-13.5	13.5 – 13.0mm	17/32"
08525-14.0	14.0 – 13.5mm	35/64"
08525-14.5	14.5 – 14.0mm	9/16"
08525-15.0	15.0 – 14.5mm	37/64"
08525-15.5	15.5 – 15.0mm	19/32"
08525-16.0	16.0 – 15.5mm	5/8"

## ER32 & TG100 COOLANT RINGS

Part No.	Shank mm	Shank inch
08532-03.5	3.5 – 3.0mm	1/8"
08532-04.0	4.0 – 3.5mm	5/32"
08532-04.5	4.5 – 4.0mm	11/64"
08532-05.0	5.0 – 4.5mm	3/16"
08532-05.5	5.5 – 5.0mm	13/64"
08532-06.0	6.0 – 5.5mm	7/32"
08532-06.5	6.5 – 6.0mm	1/4"
08532-07.0	7.0 – 6.5mm	17/64"
08532-07.5	7.5 – 7.0mm	9/32"
08532-08.0	8.0 – 7.5mm	5/16"
08532-08.5	8.5 – 8.0mm	21/64"
08532-09.0	9.0 – 8.5mm	11/32"
08532-09.5	9.5 – 9.0mm	3/8"
08532-10.0	10.0 – 9.5mm	25/64"
08532-10.5	10.5 – 10.0mm	13/32"
08532-11.0	11.0 – 10.5mm	27/64"
08532-11.5	11.5 – 11.0mm	7/16"
08532-12.0	12.0 – 11.5mm	15/32"
08532-12.5	12.5 – 12.0mm	31/64"
08532-13.0	13.0 – 12.5mm	1/2"
08532-13.5	13.5 – 13.0mm	17/32"
08532-14.0	14.0 – 13.5mm	35/64"
08532-14.5	14.5 – 14.0mm	9/16"
08532-15.0	15.0 – 14.5mm	37/64"
08532-15.5	15.5 – 15.0mm	19/32"
08532-16.0	16.0 – 15.5mm	5/8"
08532-16.5	16.5 – 16.0mm	41/64"
08532-17.0	17.0 – 16.5mm	21/32"
08532-17.5	17.5 – 17.0mm	11/16"
08532-18.0	18.0 – 17.5mm	45/64"
08532-18.5	18.5 – 18.0mm	23/32"
08532-19.0	19.0 – 18.5mm	3/4"
08532-19.5	19.5 – 19.0mm	49/64"
08532-20.0	20.0 – 19.5mm	25/32"



Use ER Coolant Rings with o-ring for coolant-thru cutting tools.



Removing the o-ring creates a CoolBLAST coolant effect.

## USE BLACK GOLD RINGS FOR COOLANT APPLICATIONS

It costs less money to use coolant rings and standard collets than coolant collets.

	ER32 Coolant Collet	ER32 Coolant Ring System
Cost of 320 collets	\$20,480.00	\$10,560.00
Cost of 20 nuts	\$ 0.00 (supplied with holders)	\$2,000.00 (includes rings)
Total 4 year cost	\$20,480.00	\$12,560.00

**\$7,920.00 savings**

Figures based on 20 toolholders, allowing 4 collets a year for each toolholder for a total of 320 collets, plus one nut for each toolholder over the four year period.

ER coolant rings are great for unattended operation. There are no rubber seals to fail under high pressure.

## ER COOLANT RING SETS

Part No.	Description
08516-14(SET)	14 pc. ER16 coolant ring set
08520-20(SET)	20 pc. ER20 coolant ring set
08525-26(SET)	26 pc. ER25 coolant ring set
08532-34(SET)	34 pc. ER32 coolant ring set
08540-46(SET)	46 pc. ER40 coolant ring set

## BLACK GOLD ER40 COOLANT RINGS

Part No.	Shank mm	Shank inch
08540-03.5	3.5 – 3.0mm	1/8"
08540-04.0	4.0 – 3.5mm	5/32"
08540-04.5	4.5 – 4.0mm	11/64"
08540-05.0	5.0 – 4.5mm	3/16"
08540-05.5	5.5 – 5.0mm	13/64"
08540-06.0	6.0 – 5.5mm	7/32"
08540-06.5	6.5 – 6.0mm	1/4"
08540-07.0	7.0 – 6.5mm	17/64"
08540-07.5	7.5 – 7.0mm	9/32"
08540-08.0	8.0 – 7.5mm	5/16"
08540-08.5	8.5 – 8.0mm	21/64"
08540-09.0	9.0 – 8.5mm	11/32"
08540-09.5	9.5 – 9.0mm	3/8"
08540-10.0	10.0 – 9.5mm	25/64"
08540-10.5	10.5 – 10.0mm	13/32"

Part No.	Shank mm	Shank inch
08540-11.0	11.0 – 10.5mm	27/64"
08540-11.5	11.5 – 11.0mm	7/16"
08540-12.0	12.0 – 11.5mm	15/32"
08540-12.5	12.5 – 12.0mm	31/64"
08540-13.0	13.0 – 12.5mm	1/2"
08540-13.5	13.5 – 13.0mm	17/32"
08540-14.0	14.0 – 13.5mm	35/64"
08540-14.5	14.5 – 14.0mm	9/16"
08540-15.0	15.0 – 14.5mm	37/64"
08540-15.5	15.5 – 15.0mm	19/32"
08540-16.0	16.0 – 15.5mm	5/8"
08540-16.5	16.5 – 16.0mm	41/64"
08540-17.0	17.0 – 16.5mm	21/32"
08540-17.5	17.5 – 17.0mm	11/16"
08540-18.0	18.0 – 17.5mm	45/64"
08540-18.5	18.5 – 18.0mm	23/32"

Part No.	Shank mm	Shank inch
08540-19.0	19.0 – 18.5mm	3/4"
08540-19.5	19.5 – 19.0mm	49/64"
08540-20.0	20.0 – 19.5mm	25/32"
08540-20.5	20.5 – 20.0mm	51/64"
08540-21.0	21.0 – 20.5mm	13/16"
08540-21.5	21.5 – 21.0mm	27/32"
08540-22.0	22.0 – 21.5mm	55/64"
08540-22.5	22.5 – 22.0mm	7/8"
08540-23.0	23.0 – 22.5mm	29/32"
08540-23.5	23.5 – 23.0mm	59/64"
08540-24.0	24.0 – 23.5mm	15/16"
08540-24.5	24.5 – 24.0mm	61/64"
08540-25.0	25.0 – 24.5mm	31/32"
08540-25.5	25.5 – 25.0mm	1.0"
08540-26.0	26.0 – 25.5mm	1 1/64"

# TG75 COLLETS & NUT



## FEATURES

- .0004" T.I.R.
- Precision ground & hand inspected
- Clamping range: 1/64"



## DIMENSIONS

Series	L	D
TG75	1.844"	1.062"

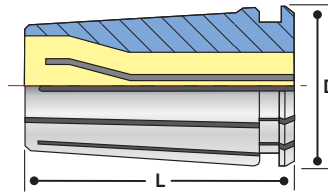

## TG75 SETS

Part No.	Pieces	ID Sizes
04008-43S	43	1/8" - 3/4" by 64ths
04008-22S	22	1/8" - 3/4" by 32nds
04008-11S	11	1/8" - 3/4" by 16ths

## TG75 COLLETS

Part No.	Shank	Part No.	Shank	Part No.	Shank	Part No.	Shank
04008-3/32	3/32"	04008-17/64	17/64"	04008-7/16	7/16"	04008-39/64	39/64"
04008-7/64	7/64"	04008-9/32	9/32"	04008-29/64	29/64"	04008-5/8	5/8"
04008-1/8	1/8"	04008-19/64	19/64"	04008-15/32	15/32"	04008-41/64	41/64"
04008-9/64	9/64"	04008-5/16	5/16"	04008-31/64	31/64"	04008-21/32	21/32"
04008-5/32	5/32"	04008-21/64	21/64"	04008-1/2	1/2"	04008-43/64	43/64"
04008-11/64	11/64"	04008-11/32	11/32"	04008-33/64	33/64"	04008-11/16	11/16"
04008-3/16	3/16"	04008-23/64	23/64"	04008-17/32	17/32"	04008-45/64	45/64"
04008-13/64	13/64"	04008-3/8	3/8"	04008-35/64	35/64"	04008-23/32	23/32"
04008-7/32	7/32"	04008-25/64	25/64"	04008-9/16	9/16"	04008-47/64	47/64"
04008-15/64	15/64"	04008-13/32	13/32"	04008-37/64	37/64"	04008-3/4	3/4"
04008-1/4	1/4"	04008-27/64	27/64"	04008-19/32	19/32"		

## TG75 POWERCOAT COLLET NUT

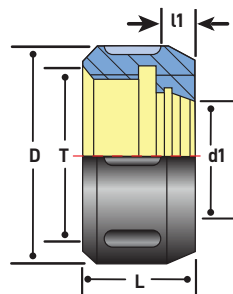

## FEATURES

- Balanced to 25,000 RPM
- Increases holding power by 75%
- Better rigidity and less T.I.R. (runout)

Part No.	Description	D	d1	T	l1	L	Wrench	Torque
84012	TG75 Collet Nut	1.88"	-	1 1/2 - 12"	0.32"	0.94"	04018	90 ft/lb





## FEATURES

- .0004" T.I.R.
- Precision ground & hand inspected
- Clamping range: 1/64"
- Metric sizes in stock



## DIMENSIONS

Series	L	D
TG100	2.375"	1.379"

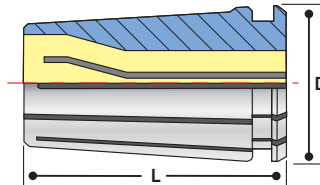

## TG100 COLLET SETS

Part No.	Pcs.	ID Sizes
04010-59S	59	3/32 - 1" by 64ths
04010-41S	41	3/8 - 1" by 64ths
04010-30S	30	3/32 - 1" by 32nds
04010-21S	21	3/8 - 1" by 32nds
04010-15S	15	1/8 - 1" by 16ths

## TG100 COLLETS

Part No.	Shank	Part No.	Shank	Part No.	Shank	Part No.	Shank
04010-3/32	3/32"	04010-21/64	21/64"	04010-9/16	9/16"	04010-25/32	25/32"
04010-7/64	7/64"	04010-11/32	11/32"	04010-37/64	37/64"	04010-51/64	51/64"
04010-1/8	1/8"	04010-23/64	23/64"	04010-19/32	19/32"	04010-13/16	13/16"
04010-9/64	9/64"	04010-3/8	3/8"	04010-39/64	39/64"	04010-53/64	53/64"
04010-5/32	5/32"	04010-25/64	25/64"	04010-5/8	5/8"	04010-27/32	27/32"
04010-11/64	11/64"	04010-13/32	13/32"	04010-41/64	41/64"	04010-55/64	55/64"
04010-3/16	3/16"	04010-27/64	27/64"	04010-21/32	21/32"	04010-7/8	7/8"
04010-13/64	13/64"	04010-7/16	7/16"	04010-43/64	43/64"	04010-57/64	57/64"
04010-7/32	7/32"	04010-29/64	29/64"	04010-11/16	11/16"	04010-29/32	29/32"
04010-15/64	15/64"	04010-15/32	15/32"	04010-45/64	45/64"	04010-59/64	59/64"
04010-1/4	1/4"	04010-31/64	31/64"	04010-23/32	23/32"	04010-15/16	15/16"
04010-17/64	17/64"	04010-1/2	1/2"	04010-47/64	47/64"	04010-61/64	61/64"
04010-9/32	9/32"	04010-33/64	33/64"	04010-3/4	3/4"	04010-31/32	31/32"
04010-19/64	19/64"	04010-17/32	17/32"	04010-49/64	49/64"	04010-63/64	63/64"
04010-5/16	5/16"	04010-35/64	35/64"	04010-20	20mm	04010-1	1.0"

## TG100 POWERCOAT NUT

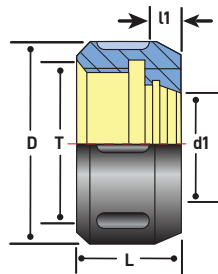

## FEATURES

- Balanced to 25,000 RPM
- Increases holding power by 75%
- Better rigidity and less T.I.R. (runout)

Part No.	Description	D	d1	T	l1	L	Spanner	Torque
28110	TG100 Collet Nut	2.35"	1.12"	1-7/8" - 12	0.44"	1.18"	03691	95 ft/lbs.
28210	TG100 Coolant Collet Nut	2.35"	.95"	1-7/8" - 12	0.44"	1.41"	03691	95 ft/lbs.

# TG100 COOLANT COLLETS



## FEATURES

- .0004" T.I.R.
- Up to 750 PSI coolant
- Clamping range: 1/64"



## DIMENSIONS

Series	L	D
TG100	2.375"	1.379"

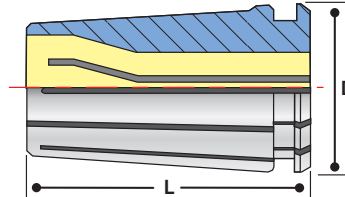

## TG100 COOLANT COLLET SETS

Part No.	Pcs.	ID Sizes
84063-25(SET)	25	1/4" - 1.0" by 64ths
84063-57S	57	1/8" - 1.0" by 64ths

## TG100 COOLANT COLLETS

Part No.	Shank Size	Part No.	Shank Size	Part No.	Shank Size	Part No.	Shank Size
84063-3/32	3/32"	84063-9/32	9/32"	84063-1/2	1/2"	84063-3/4	3/4"
84063-7/64	7/64"	84063-19/64	19/64"	84063-33/64	33/64"	84063-49/64	49/64"
84063-1/8	1/8"	84063-5/16	5/16"	84063-17/32	17/32"	84063-25/32	25/32"
84063-9/64	9/64"	84063-21/64	21/64"	84063-9/16	9/16"	84063-51/64	51/64"
84063-5/32	5/32"	84063-11/32	11/32"	84063-19/32	19/32"	84063-13/16	13/16"
84063-11/64	11/64"	84063-23/64	23/64"	84063-39/64	39/64"	84063-53/64	53/64"
84063-3/16	3/16"	84063-3/8	3/8"	84063-5/8	5/8"	84063-27/32	27/32"
84063-13/64	13/64"	84063-13/32	13/32"	84063-41/64	41/64"	84063-55/64	55/64"
84063-7/32	7/32"	84063-27/64	27/64"	84063-21/32	21/32"	84063-7/8	7/8"
84063-15/64	15/64"	84063-7/16	7/16"	84063-43/64	43/64"	84063-57/64	57/64"
84063-1/4	1/4"	84063-29/64	29/64"	84063-11/16	11/16"	84063-29/32	29/32"
84063-17/64	17/64"	84063-15/32	15/32"	84063-23/32	23/32"	84063-59/64	59/64"
		84063-31/64	31/64"	84063-47/64	47/64"	84063-15/16	15/16"
						84063-61/64	61/64"
						84063-31/32	31/32"
						84063-63/64	63/64"
						84063-1	1.0"



## FEATURES

- .0004" T.I.R.
- Precision ground & hand inspected
- Clamping range: 1/64"



## DIMENSIONS

Series	L	D
TG150	3.0"	2.001"

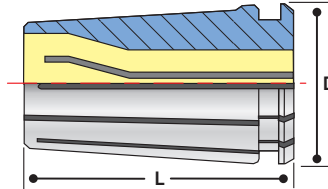

## TG150 COLLET SETS

Part No.	Pieces	ID Sizes
04011-65S	65	1/2 - 1 1/2" by 64ths
04011-33S	33	1/2 - 1 1/2" by 32nds
04011-17S	17	1/2 - 1 1/2" by 16ths

## TG150 COLLETS

Part No.	Shank
04011-17/64	17/64"
04011-3/8	3/8"
04011-7/32	7/32"
04011-1/2	1/2"
04011-33/64	33/64"
04011-17/32	17/32"
04011-35/64	35/64"
04011-9/16	9/16"
04011-37/64	37/64"
04011-19/32	19/32"
04011-39/64	39/64"
04011-5/8	5/8"
04011-41/64	41/64"
04011-21/32	21/32"
04011-43/64	43/64"
04011-11/16	11/16"
04011-45/64	45/64"

Part No.	Shank
04011-23/32	23/32"
04011-47/64	47/64"
04011-3/4	3/4"
04011-49/64	49/64"
04011-25/32	25/32"
04011-51/64	51/64"
04011-13/16	13/16"
04011-53/64	53/64"
04011-27/32	27/32"
04011-55/64	55/64"
04011-7/8	7/8"
04011-57/64	57/64"
04011-29/32	29/32"
04011-59/64	59/64"
04011-15/16	15/16"
04011-61/64	61/64"

Part No	Shank
04011-31/32	31/32"
04011-63/64	63/64"
04011-1	1 0"
04011-1 1/64	1-1/64"
04011-1 1/32	1-1/32"
04011-1 3/64	1-3/64"
04011-1 1/16	1-1/16"
04011-1 5/64	1-5/64"
04011-1 3/32	1-3/32"
04011-1 7/64	1-7/64"
04011-1 1/8	1-1/8"
04011-1 9/64	1-9/64"
04011-1 5/32	1-5/32"
04011-1 11/64	1-11/64"
04011-1 3/16	1-3/16"
04011-1 13/64	1-13/64"
04011-1 7/32	1-7/32"
04011-1 15/64	1-15/64"

Part No	Shank
04011-1 1/4	1-1/4"
04011-1 17/64	1-17/64"
04011-1 9/32	1-9/32"
04011-1 19/64	1-19/64"
04011-1 5/16	1-5/16"
04011-1 21/64	1-21/64"
04011-1 11/32	1-11/32"
04011-1 23/64	1-23/64"
04011-1 3/8	1-3/8"
04011-1 25/64	1-25/64"
04011-1 13/32	1-13/32"
04011-1 27/64	1-27/64"
04011-1 7/16	1-7/16"
04011-1 29/64	1-29/64"
04011-1 15/32	1-15/32"
04011-1 31/64	1-31/64"
04011-1 1/2	1-1/2"

# SYOZ / EOC (DIN 6388) PERSKE STYLE



pg. 62

pg. 64

pg. 229

pg. 236

pg. 238



## FEATURES

- T.I.R. (runout) .0004"
- Collapse range: 1/64"
- Made from high-carbon steel

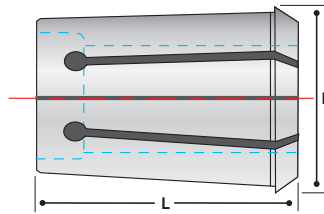

## DIMENSIONS

Part No.	L	D
SYOZ 20	34mm	20mm
SYOZ 25	52mm	35mm
EOC 08	26mm	14.4mm
EOC 16	40mm	25.5mm

These collets and collet nuts conform to DIN 6388 standards. Snap collet into the nut before screwing the nut onto the spindle or holder.

## EOC8

Part No.	Shank Size
83508-0.109	0.109"
83508-1/8	1/8"
83508-3/16	3/16"
83508-1/4	1/4"
03508-17/64	17/64"
83508-3/8	3/8"
83508-5/16	5/16"
03508-03	3mm
03508-04	4mm
03508-08	8mm
03508-L	LH nut
83508-NUT	Nut

## EOC 12

Part No.	Shank Size
83512-1/8	1/8"
83512-3/16	3/16"
83512-1/4	1/4"
83512-5/16	5/16"
83512-3/8	3/8"
83512-7/16	7/16"
83512-1/2	1/2"
83512-10	10mm

## SYOZ25

Part No.	Shank Size
83868-1/8	1/8"
83868-3/16	3/16"
83868-1/4	1/4"
83868-5/16	5/16"
83868-3/8	3/8"
83868-7/16	7/16"
83868-1/2	1/2"
83868-9/16	9/16"
83868-5/8	5/8"
83868-3/4	3/4"
83868-7/8	7/8"
83868-1	1.0"
83868-10	10mm
83868-16	16mm
83868-20	20mm
83868-25	25mm

SYOZ20 available upon request.

## EOC16

Part No.	Shank Size
83531-1/8	1/8"
83531-3/16	3/16"
83531-1/4	1/4"
83531-3/8	3/8"
83531-5/16	5/16"
83531-7/16	7/16"
83531-1/2	1/2"
83531-9/16	9/16"
83531-5/8	5/8"
83531-02	2mm
83531-03	3mm
83531-04	4mm
83531-05	5mm
83531-06	6mm
83531-07	7mm
83531-08	8mm
83531-09	9mm
83531-10	10mm
83531-11	11mm
83531-12	12mm
83531-13	13mm
83531-14	14mm
83531-15	15mm
83531-16	16mm

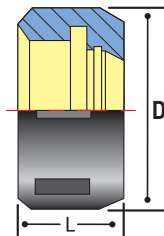

## FEATURES

- Balanced to 25,000 RPM
- Increases holding power by 75%
- Better rigidity and less T.I.R. (runout)

## DIN 6388 NUTS AND WRENCHES

Part No.	Description	L	D	Wrench
83508-NUT	EOC08 nut	19	30	-
03636-NUT	EOC16 nut	24	43	03636
83634	SYOZ20/EOC 12 nut	20	35	22220
83634-L	SYOZ20/EOC 12 left-hand nut	20	35	22220
83632	SYOZ25 PowerCOAT nut	30	60	03691



pg. 62



pg. 64



pg. 229



pg. 236



pg. 238

# DOUBLE ANGLE (DA) COLLETS

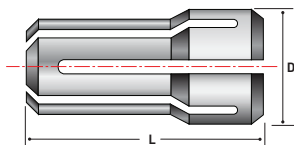

## DIMENSIONS

Series	L	D
DA180	1.625"	1.035"
DA100	1.438"	0.769"
DA200	1.188"	0.531"
DA300	1.000"	0.375"

## FEATURES

- Collapse range: 1/64"
- Made from high-carbon steel
- Precision ground accuracy

DA180	Size
01618-1/16	1/16"
01618-5/64	5/64"
01618-3/32	3/32"
01618-7/64	7/64"
01618-1/8	1/8"
01618-9/64	9/64"
01618-5/32	5/32"
01618-11/64	11/64"
01618-3/16	3/16"
01618-13/64	13/64"
01618-7/32	7/32"
01618-15/64	15/64"
01618-1/4	1/4"
01618-17/64	17/64"
01618-9/32	9/32"
01618-19/64	19/64"
01618-5/16	5/16"
01618-21/64	21/64"
01618-11/32	11/32"
01618-23/64	23/64"
01618-3/8	3/8"
01618-25/64	25/64"
01618-13/32	13/32"
01618-27/64	27/64"
01618-7/16	7/16"
01618-29/64	29/64"
01618-15/32	15/32"
01618-31/64	31/64"
01618-1/2	1/2"
01618-33/64	33/64"

DA180	Size
01618-17/32	17/32"
01618-35/64	35/64"
01618-9/16	9/16"
01618-37/64	37/64"
01618-19/32	19/32"
01618-39/64	39/64"
01618-5/8	5/8"
01618-41/64	41/64"
01618-21/32	21/32"
01618-43/64	43/64"
01618-11/16	11/16"
01618-45/64	45/64"
01618-23/32	23/32"
01618-47/64	47/64"
01618-3/4	3/4"

DA100	Size
01610-1/16	1/16"
01610-5/64	5/64"
01610-3/32	3/32"
01610-7/64	7/64"
01610-1/8	1/8"
01610-9/64	9/64"
01610-5/32	5/32"
01610-11/64	11/64"
01610-3/16	3/16"
01610-13/64	13/64"
01610-7/32	7/32"
01610-15/64	15/64"
01610-1/4	1/4"

## DOUBLE ANGLE COLLET SETS

DA180	Description	DA100	Description
01618-9S	9pc 1/4 - 3/4" by 16 <sup>ths</sup>	01610-8S	8pc 1/8 - 9/16" by 16 <sup>ths</sup>
01618-17S	17pc 1/4 - 3/4" by 32 <sup>nds</sup>	01610-15S	15pc 1/8 - 9/16" by 32 <sup>nds</sup>
01618-21S	21pc 1/8 - 3/4" by 32 <sup>nds</sup>	01610-21S	21pc 1/4 - 9/16" by 64 <sup>ths</sup>
01618-33S	33pc 1/4 - 3/4" by 64 <sup>ths</sup>	01610-29S	29pc 1/8 - 9/16" by 64 <sup>ths</sup>
01618-41S	41pc 1/8 - 3/4" by 64 <sup>ths</sup>	01610-33S	33pc 1/16 - 9/16" by 64 <sup>ths</sup>

DA200	Description	DA300	Description
01620-9S	9pc 1/8 - 3/8" by 32 <sup>nds</sup>	01630-7S	7pc 1/16 - 1/4" by 32 <sup>nds</sup>
01620-17S	17pc 1/8 - 3/8" by 64 <sup>ths</sup>	01630-14S	14pc 3/64 - 1/4" by 64 <sup>ths</sup>
01620-21S	21pc 1/16 - 3/8" by 64 <sup>ths</sup>		

DA100	Size
01610-17/64	17/64"
01610-9/32	9/32"
01610-19/64	19/64"
01610-5/16	5/16"
01610-21/64	21/64"
01610-11/32	11/32"
01610-23/64	23/64"
01610-3/8	3/8"
01610-25/64	25/64"
01610-13/32	13/32"
01610-27/64	27/64"
01610-7/16	7/16"
01610-29/64	29/64"
01610-15/32	15/32"
01610-31/64	31/64"
01610-1/2	1/2"
01610-33/64	33/64"
01610-17/32	17/32"
01610-35/64	35/64"
01610-9/16	9/16"

DA200	Size
01620-3/64	3/64"
01620-1/16	1/16"
01620-5/64	5/64"
01620-3/32	3/32"
01620-7/64	7/64"
01620-1/8	1/8"
01620-9/64	9/64"
01620-5/32	5/32"

DA200	Size
01620-11/64	11/64"
01620-3/16	3/16"
01620-13/64	13/64"
01620-7/32	7/32"
01620-15/64	15/64"
01620-1/4	1/4"
01620-17/64	17/64"
01620-9/32	9/32"
01620-19/64	19/64"
01620-5/16	5/16"
01620-21/64	21/64"
01620-11/32	11/32"
01620-23/64	23/64"
01620-3/8	3/8"

DA300	Size
01630-3/64	3/64"
01630-1/16	1/16"
01630-5/64	5/64"
01630-3/32	3/32"
01630-7/64	7/64"
01630-1/8	1/8"
01630-9/64	9/64"
01630-5/32	5/32"
01630-11/64	11/64"
01630-3/16	3/16"
01630-13/64	13/64"
01630-7/32	7/32"
01630-15/64	15/64"
01630-1/4	1/4"





# COLLET I.D. GUIDE AND SPECIAL ORDERS



Use the guide below for selecting replacement collets. The best way to tell what type of collet you have is to measure the length of the collet. Collets all have unique measurements. For best results always use a PowerCOAT nut tightened to proper specification using an accurate torque wrench.

ER Collet	L	D	Torque Spec
ER8	13mm (.51")	8.5mm (.33")	-
ER11	18mm (.708")	11.5mm (.45")	17 ft/lbs
ER16	27.5mm (1.08")	17mm (.67")	42 ft/lbs
ER20	31.5mm (1.24")	21mm (.83")	59 ft/lbs
ER25	34mm (1.34")	26mm (1.02")	77 ft/lbs
ER32	40mm (1.57")	33mm (1.3")	100 ft/lbs
ER40	46mm (1.81")	41mm (1.61")	130 ft/lbs
ER50	60mm (2.36")	52mm (2.05")	130 ft/lbs

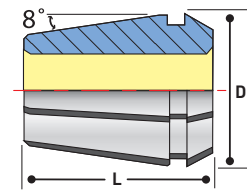

ER Collet Style

TG Collet	L	D	Torque Spec
TG75	47mm (1.85")	27mm (1.06")	90 ft/lbs
TG100	60mm (2.36")	35mm (1.38")	90 ft/lbs
TG150	76mm (3")	51mm (2")	110 ft/lbs

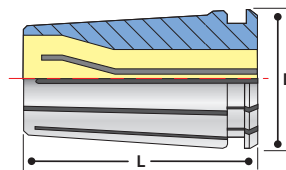

TG Collet Style

SYOZ / EOC Collet	L	D
EOC8	26mm (1.026")	14.4mm (.567")
SYOZ20	34mm (1.34")	20mm (.78")
RDO 20	34mm (1.34")	20mm (.78")
407E	34mm (1.34")	20mm (.78")
EOC 12	34mm (1.34")	20mm (.78")
SYOZ25	52mm (2.06")	35mm (1.38")
RDO 35	52mm (2.06")	35mm (1.38")
462E / SYOZ25	52mm (2.06")	35mm (1.38")
EOC 32	60mm (2.36")	43.7mm (1.72")

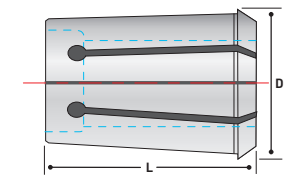

SYOZ Collet Style

DA Collet	L	D
DA180	1.625"	1.035"
DA100	1.438"	.769"
DA200	1.188"	.531"
DA300	1.000"	.375"

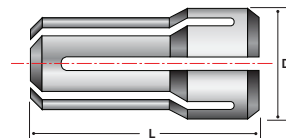

DA Collet Style

DNA Collet	L	D
DNA 11	16.9mm (0.67")	11.5mm (0.45")
DNA 16	24mm (0.94")	17mm (0.67")
DNA 20	30.42mm (1.20")	21.10mm (0.83")
DNA 32	40mm (1.57")	33.25mm (1.31")

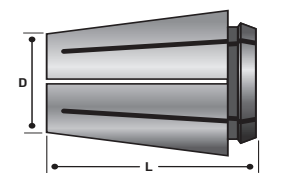

DNA Collet Style

SlimFIT Collet	T	Torque Spec
SBL6	M6 x 1.0P	9 ft/lbs
SBL12	M10 x 1.5P	44 ft/lbs
SBL20	M12 x 1.75P	74 ft/lbs

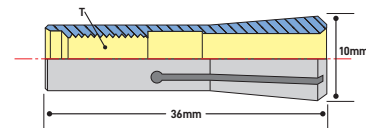

SlimFIT Collet Style

## SPECIAL ORDER COLLETS – CALL US FOR ASSISTANCE

Length \_\_\_\_\_ Diameter \_\_\_\_\_ Other Markings \_\_\_\_\_



# TECHNIKS CERTIFIED END MILL HOLDERS

## QUALITY & PERFORMANCE GUARANTEED

### H5 BORE TOLERANCE EXTENDS TOOL LIFE

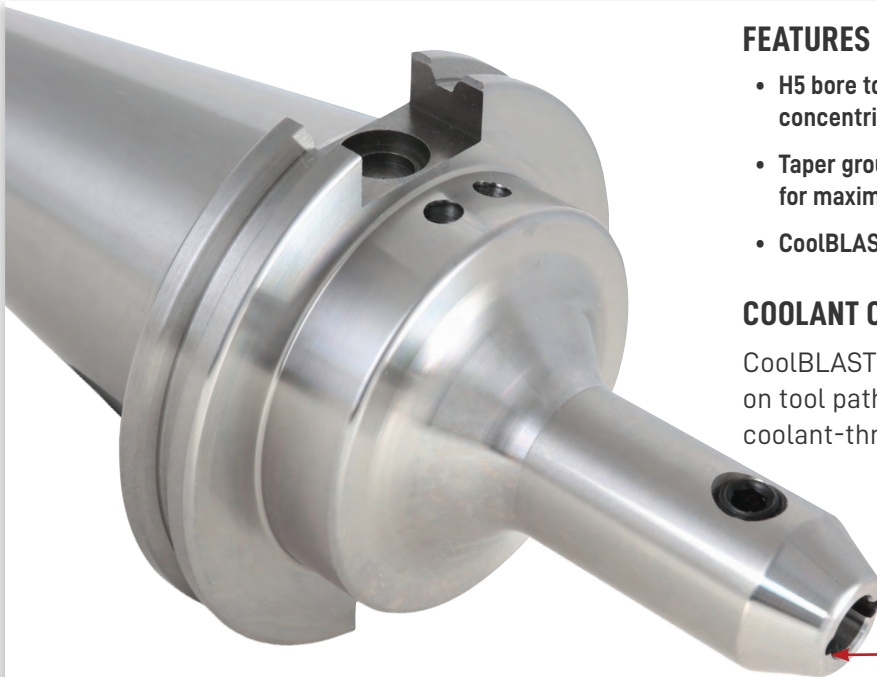

#### FEATURES

- H5 bore tolerance for improved concentricity and tool life
- Taper ground to AT3 specification for maximum spindle contact
- CoolBLAST and CoolFLEX coolant options

#### COOLANT OPTIONS

CoolBLAST coolant channels direct coolant on tool path. CoolFLEX holders feature coolant-thru tool or DIN B coolant.

CoolBLAST channels

**BRAND X = .0008"**

**TECHNIKS = .0002"**

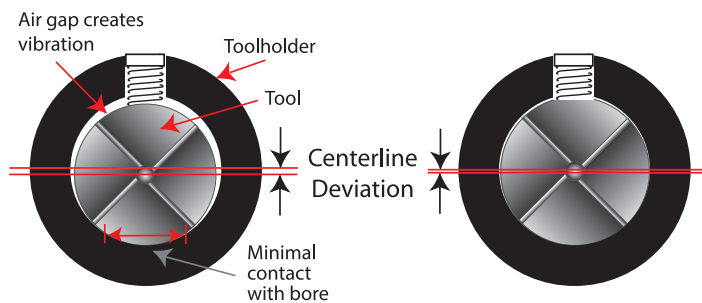

**YOU LOSE 10% OF TOOL LIFE FOR EVERY .0001" OF T.I.R.  
TECHNIKS H5 BORE TOLERANCE EXTENDS CUTTING TOOL LIFE.**



All Techniks products are backed by our 100% satisfaction guarantee!



We stand behind all our products with our 100% Satisfaction Guarantee • [www.techniksusa.com](http://www.techniksusa.com)



Techniks Certified for accuracy and balance. Each holder comes with a complete lab report. Techniks H5 bore tolerance extends tool life.

## FEATURES

- H5 bore tolerance for improved concentricity and tool life
- Taper ground to AT3 specification for maximum spindle contact
- Balanced to 15,000 RPM at G6.3

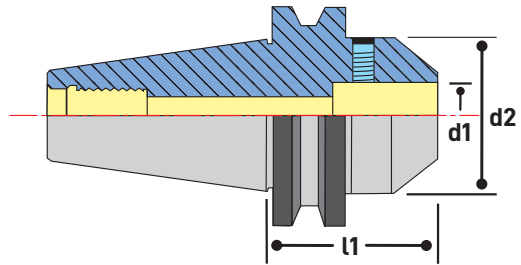

## CAT40 END MILL HOLDERS **STUBBY LENGTH**

Part No.	Description	l1	d1	d2
22907-1.75	CAT40 x SLN 1/8" - 1.75"	1.75"	1/8"	.75"
22909-1.75	CAT40 x SLN 3/16" - 1.75"	1.75"	3/16"	.79"
22911-1.75	CAT40 x SLN 1/4" - 1.75"	1.75"	1/4"	.79"
22913-1.75	CAT40 x SLN 5/16" - 1.75"	1.75"	5/16"	.88"
22915-1.75	CAT40 x SLN 3/8" - 1.75"	1.75"	3/8"	.88"
22916-1.75	CAT40 x SLN 7/16" - 1.75"	1.75"	7/16"	1.12"
22917-1.75	CAT40 x SLN 1/2" - 1.75"	1.75"	1/2"	1.5"
22919-1.75	CAT40 x SLN 5/8" - 1.75"	1.75"	5/8"	1.5"
22921-1.75	CAT40 x SLN 3/4" - 1.75"	1.75"	3/4"	1.75"
22925A-1.75	CAT40 x SLN 1" - 1.75"	1.75"	1"	2"
22927A-2	CAT40 x SLN 1-1/4" - 2"	2"	1-1/4"	2.5"

### Techniks H5 Bore Tolerance Extends Tool Life 60%

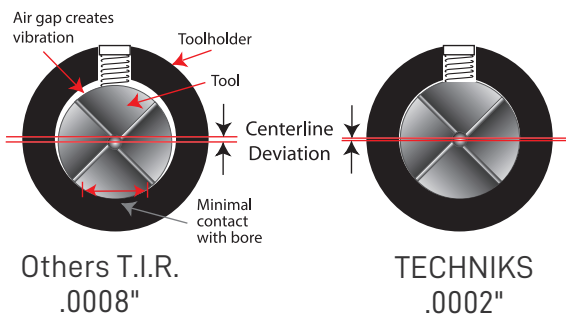

All Techniks end mill holder bores are manufactured to meet or exceed the H5 specification.

H5 is an extremely accurate bore I.D. and provides improved T.I.R. for extended cutting tool life.



pg. 94



pg. 229



pg. 236



pg. 238

# CAT40 END MILL HOLDERS

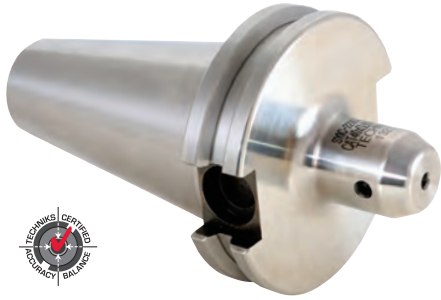

## FEATURES

- H5 bore tolerance for improved concentricity and tool life
- Taper ground to AT3 specification for maximum spindle contact
- Balanced to 15,000 RPM at G6.3

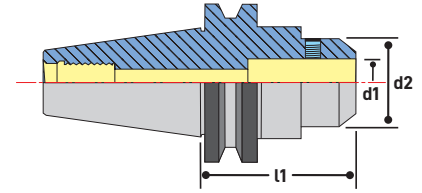

## CAT40 END MILL HOLDERS INCH & METRIC

Part No.	Description	l1	d1	d2
22907	CAT40 x SLN 1/8" - 2.37"	2.37"	1/8"	.69"
22909	CAT40 x SLN 3/16" - 2.5"	2.5"	3/16"	.69"
22911	CAT40 x SLN 1/4" - 3"	3"	1/4"	.78"
22911-2.5	CAT40 x SLN 1/4" - 2.5	2.5"	1/4"	.78"
22913	CAT40 x SLN 5/16" - 3"	3"	5/16"	.88"
22913-2.5	CAT40 x SLN 5/16" - 2.5"	2.5"	5/16"	.88"
22915	CAT40 x SLN 3/8" - 3"	3"	3/8"	1"
22915-2.5	CAT40 x SLN 3/8" - 2.5"	2.5"	3/8"	1"
22916-2.5	CAT40 x SLN 7/16" - 2.5"	2.5"	7/16"	1.13"
22917	CAT40 x SLN 1/2" - 3"	3"	1/2"	1.25"
22917-2.5	CAT40 x SLN 1/2" - 2.5"	2.5"	1/2"	1.25"
22917-2.63	CAT40 x SLN 1/2" - 2.63"	2.63"	1/2"	1.25"
22919	CAT40 x SLN 5/8" - 3"	3"	5/8"	1.5"
22920	CAT40 x SLN 5/8" - 3.75"	3.75"	5/8"	1.5"
22921	CAT40 x SLN 3/4" - 3.5"	3.5"	3/4"	1.75"
22921-3	CAT40 x SLN 3/4" - 3"	3"	3/4"	1.75"
22923	CAT40 x SLN 7/8" - 3.5"	3.5"	7/8"	1.88"
22925-3	CAT40 x SLN 1" - 3"	3"	1"	2"
22925	CAT40 x SLN 1" - 4"	4"	1"	2"
22927	CAT40 x SLN 1.25" - 4.6"	4.6"	1.25"	2.5"
22927-4	CAT40 x SLN 1.25" - 4"	4"	1.25"	2.5"
22929	CAT40 x SLN 1.5" - 4.5"	4.5"	1.5"	2.5"
22963	CAT40 x SLN 6mm - 63.5mm	63.5mm	6mm	25mm
22965	CAT40 x SLN 8mm - 63.5mm	63.5mm	8mm	28mm
22967	CAT40 x SLN 10mm - 63.5mm	63.5mm	10mm	35mm
22969	CAT40 x SLN 12mm - 63.5mm	63.5mm	12mm	42mm
22971	CAT40 x SLN 16mm - 63.5mm	63.5mm	16mm	44.45mm
22973	CAT40 x SLN 20mm - 76.2mm	76.2mm	20mm	44.45mm
22975	CAT40 x SLN 25mm - 101.6mm	101.6mm	25mm	65mm
22977	CAT40 x SLN 32mm - 101.6mm	101.6mm	32mm	72mm

# CAT40 END MILL HOLDERS

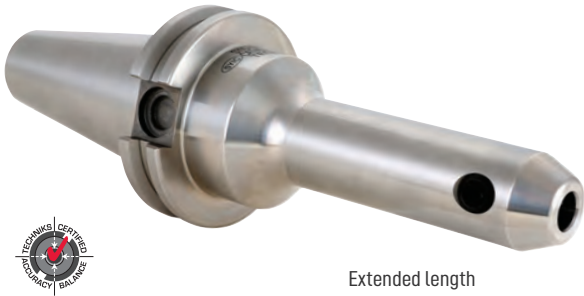

Extended length

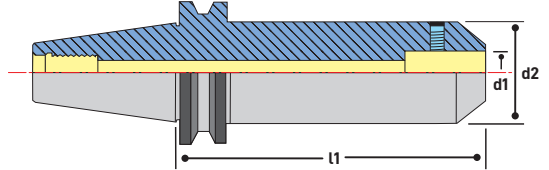

## CAT40 END MILL HOLDERS EXTENDED LENGTH

Part No.	Description	l1	d1	d2
22907-6	CAT40 x SLN 1/8" - 6"	6"	1/8"	.69"
22909-6	CAT40 x SLN 3/16" - 6"	6"	3/16"	.69"
22911-6	CAT40 x SLN 1/4" - 6"	6"	1/4"	.78"
22915-5	CAT40 x SLN 3/8" - 5"	5"	3/8"	1"
22915-6	CAT40 x SLN 3/8" - 6"	6"	3/8"	1"
22917-4.63	CAT40 x SLN 1/2" - 4.63"	4.63"	1/2"	1.25"
22917-6	CAT40 x SLN 1/2" - 6"	6"	1/2"	1.25"
22920-5.75	CAT40 x SLN 5/8" - 5.75"	5.75"	5/8"	1.5"
22921-5	CAT40 x SLN 3/4" - 5"	5"	3/4"	1.75"
22921-6.5	CAT40 x SLN 3/4" - 6.5"	6.5"	3/4"	1.75"
22925-6	CAT40 x SLN 1" - 6"	6"	1"	2"
22927-6	CAT40 x SLN 1 - 1/4" - 6"	6"	1 - 1/4"	2.5"



Rigid Reach

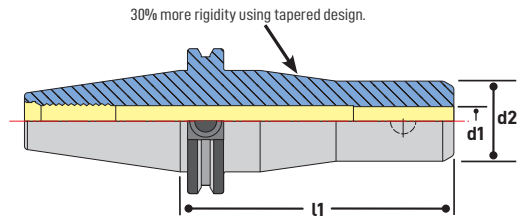

Our Rigid Reach End Mill holders are great for machining in tight areas or at extended length where tolerance is important. The tapered design improves rigidity and overall cutting performance.



## CAT40 END MILL HOLDERS RIGID REACH

Part No.	Description	l1	d1	d2
22907-5.00-RR	CAT40 x SLN 1/8" - 5"	5"	1/8"	.78"
22909-4.72-RR	CAT40 x SLN 3/16" - 4.72"	4.72"	3/16"	.78"
22911-4.72-RR	CAT40 x SLN 1/4" - 4.72"	4.72"	1/4"	.78"
22913-4.72-RR	CAT40 x SLN 5/16" - 4.72"	4.72"	5/16"	.86"
22915-4.72-RR	CAT40 x SLN 3/8" - 4.72"	4.72"	3/8"	1"
22917-4.72-RR	CAT40 x SLN 1/2" - 4.72"	4.72"	1/2"	1.38"



pg. 94



pg. 229



pg. 236



pg. 238

# CAT40 END MILL HOLDERS - COOLBLAST

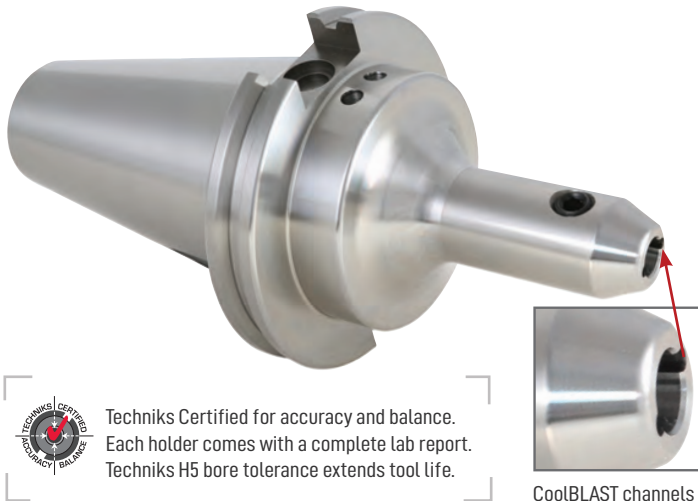

## FEATURES

- Coolant channels in the bore direct coolant precisely to the cutting edge
- Effective removal of chips for faster feed rates
- H5 bore tolerance for improved concentricity and tool life

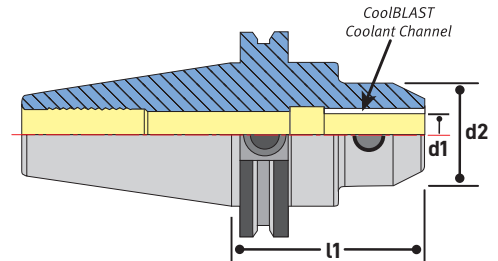

## CAT40 END MILL HOLDERS COOLBLAST

Part No.	Description	l1	d1	d2
22909-4B	CAT40 x SLN 3/16" - 4"	4"	3/16"	.69"
22909-6B	CAT40 x SLN 3/16" - 6"	6"	3/16"	.69"
22911-2.5B	CAT40 x SLN 1/4" - 2.5"	2.5"	1/4"	.78"
22911-6B	CAT40 x SLN 1/4" - 6"	6"	1/4"	.78"
22915-2.5B	CAT40 x SLN 3/8" - 2.5"	2.5"	3/8"	1"
22915-4B	CAT40 x SLN 3/8" - 4"	4"	3/8"	1"
22917-2.5B	CAT40 x SLN 1/2" - 2.5"	2.5"	1/2"	1.25"
22917B	CAT40 x SLN 1/2" - 3"	3"	1/2"	1.25"
22917-4B	CAT40 x SLN 1/2" - 4"	4"	1/2"	1.25"
22917-6B	CAT40 x SLN 1/2" - 6"	6"	1/2"	1.25"
22919B	CAT40 x SLN 5/8" - 3"	3"	5/8"	1.5"
22919-4B	CAT40 x SLN 5/8" - 4"	4"	5/8"	1.5"
22921-1.75B	CAT40 x SLN 3/4" - 1.75"	1.75"	3/4"	1.75"
22921-3B	CAT40 x SLN 3/4" - 3"	3"	3/4"	1.75"
22921-4B	CAT40 x SLN 3/4" - 4"	4"	3/4"	1.75"
22925B	CAT40 x SLN 1" - 4"	4"	1"	2"
22927B	CAT40 x SLN 1-1/4" - 4.6"	4.6"	1-1/4"	2.5"

## CAT40 END MILL HOLDERS RIGID REACH WITH COOLBLAST

Part No.	Description	l1	d1	d2
22907-4.72B-RR	CAT40 x SLN 1/8" - 4.72"	4.72"	1/8"	.78"
22909-4.72B-RR	CAT40 x SLN 3/16" - 4.72"	4.72"	3/16"	.78"
22911-4.75B-RR	CAT40 x SLN 1/4" - 4.75"	4.75"	1/4"	.78"
22913-4.72B-RR	CAT40 x SLN 5/16" - 4.72"	4.72"	5/16"	.86"
22915-4.72B-RR	CAT40 x SLN 3/8" - 4.72"	4.72"	3/8"	1"
22917-4.72B-RR	CAT40 x SLN 1/2" - 4.72"	4.72"	1/2"	1.38"





# CAT40 END MILL HOLDERS - COOLBLAST



## FEATURES

- Coolant channels in the bore direct coolant precisely to the cutting edge
- Effective removal of chips for faster feed rates
- Through spindle and DIN-B coolant enabled



Techniks Certified for accuracy and balance. Each holder comes with a complete lab report. Techniks H5 bore tolerance extends tool life.

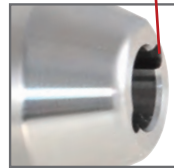

CoolBLAST channels

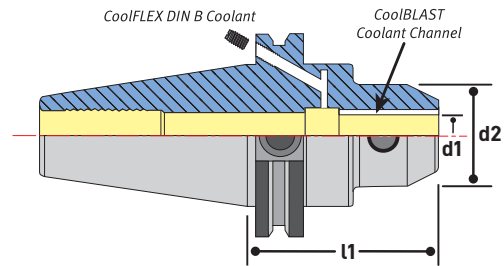

### Techniks H5 Bore Tolerance Extends Tool Life 60%

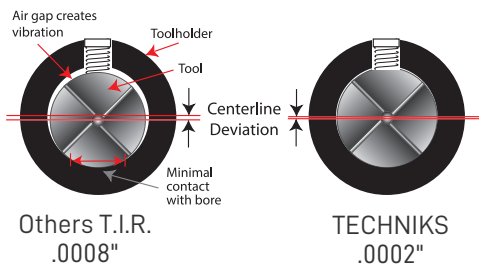

### COOLFLEX FEATURE

CoolFLEX holders are factory set for coolant-thru spindle. Remove the stop screws for DIN B coolant-thru flange.

Part No.	Description
HSA-4-6	40 taper DIN B screw

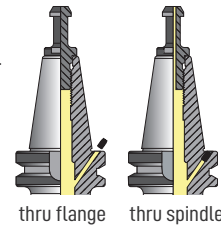

## CAT40 END MILL HOLDERS COOLBLAST WITH COOLFLEX

Part No.	Description	l1	d1	d2
22909-6FB	CAT40 x SLN 3/16" - 6"	6"	3/16"	.69"
22911-2.5FB	CAT40 x SLN 1/4" - 2.5"	2.5"	1/4"	.78"
22911-4FB	CAT40 x SLN 1/4" - 4"	4"	1/4"	.78"
22911-6FB	CAT40 x SLN 1/4" - 6"	6"	1/4"	.78"
22913-6FB	CAT40 x SLN 5/16" - 6"	6"	5/16"	.88"
22915-2.5FB	CAT40 x SLN 3/8" - 2.5"	2.5"	3/8"	1"
22915-5FB	CAT40 x SLN 3/8" - 5"	5"	3/8"	1"
22917-2.5FB	CAT40 x SLN 1/2" - 2.5"	2.5"	1/2"	1.25"
22917-4FB	CAT40 x SLN 1/2" - 4"	4"	1/2"	1.25"
22919-1.75FB	CAT40 x SLN 5/8" - 1.75"	1.75"	5/8"	1.5"
22920-6FB	CAT40 x SLN 5/8" - 6"	6"	5/8"	1.5"
22921-3FB	CAT40 x SLN 3/4" - 3"	3"	3/4"	1.75"
22925FB	CAT40 x SLN 1" - 4"	4"	1"	2"



pg. 94



pg. 229



pg. 236



pg. 238

# CAT40 END MILL HOLDERS - COOLFLEX

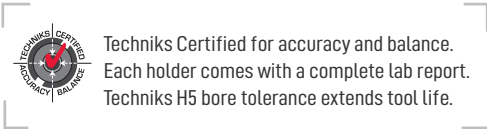

Techniks Certified for accuracy and balance. Each holder comes with a complete lab report. Techniks H5 bore tolerance extends tool life.

## Techniks H5 Bore Tolerance Extends Tool Life 60%

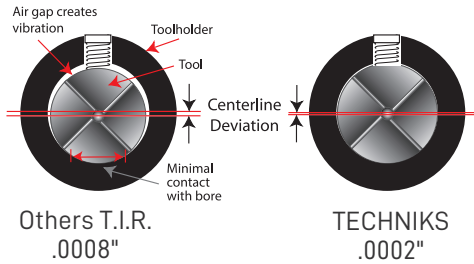

## FEATURES

- Through spindle and DIN-B coolant enabled
- H5 bore tolerance for improved concentricity and tool life
- Balanced to 15,000 RPM @ G6.3

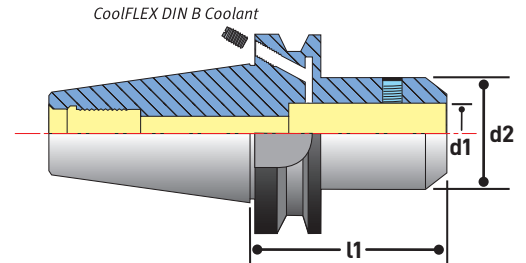

## COOLFLEX FEATURE

CoolFLEX holders are factory set for coolant-thru spindle. Remove the stop screws for DIN B coolant-thru flange.

Part No.	Description
HSA-4-6	40 taper DIN B screw

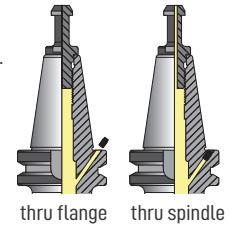

## CAT40 END MILL HOLDER COOLFLEX

Part No.	Description	l1	d1	d2
22911F	CAT40 x SLN 1/4" - 3"	3"	1/4"	.78"
22911-2.5F	CAT40 x SLN 1/4" - 2.5"	2.5"	1/4"	.78"
22913-2.5F	CAT40 x SLN 5/16" - 2.5"	2.5"	5/16"	.88"
22913F	CAT40 x SLN 5/16" - 3"	3"	5/16"	.88"
22915-2.5F	CAT40 x SLN 3/8" - 2.5"	2.5"	3/8"	1"
22915F	CAT40 x SLN 3/8" - 3"	3"	3/8"	1"
22915-5F	CAT40 x SLN 3/8" - 5"	5"	3/8"	1"
22916-2.5F	CAT40 x SLN 7/16" - 2.5"	2.5"	7/16"	1.13"
22917F	CAT40 x SLN 1/2" - 3"	3"	1/2"	1.25"
22919-1.75F	CAT40 x SLN 5/8" - 1.75"	1.75"	5/8"	1.5"
22919F	CAT40 x SLN 5/8" - 3"	3"	5/8"	1.5"
22921-1.75F	CAT40 x SLN 3/4" - 1.75"	1.75"	3/4"	1.75"
22921-3F	CAT40 x SLN 3/4" - 3"	3"	3/4"	1.75"
22921-5F	CAT40 x SLN 3/4" - 5"	5"	3/4"	1.75"
22925-1.75F	CAT40 x SLN 1" - 1.75"	1.75"	1"	2"
22925F	CAT40 x SLN 1" - 4"	4"	1"	2"
22927F	CAT40 x SLN 1-1/4" - 4.6"	4.6"	1-1/4"	2.5"
22929F	CAT40 x SLN 1-1/2" - 4.5"	4.5"	1-1/2"	2.5"



# CAT40 END MILL HOLDERS - DUALDRIVE

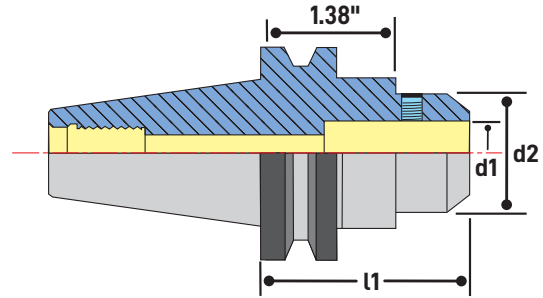

## CAT40 END MILL HOLDERS **DUALDRIVE**

Part No.	Description	l1	d1	d2
43.653.53.300	SCAT40 x SLN 3/16" - 3" DualDRIVE	3"	3/16"	.69"
43.653.54.300	SCAT40 x SLN 1/4" - 3" DualDRIVE	3"	1/4"	.78"
43.653.55.300	SCAT40 x SLN 5/16" - 3" DualDRIVE	3"	5/16"	.88"
43.653.56.300	SCAT40 x SLN 3/8" - 3" DualDRIVE	3"	3/8"	1"
43.653.56.500	SCAT40 x SLN 3/8" - 5" DualDRIVE	5"	3/8"	1"
43.653.57.300	SCAT40 x SLN 7/16" - 3" DualDRIVE	3"	3/4"	1.13"
43.653.58.300	SCAT40 x SLN 1/2" - 3" DualDRIVE	3"	1/2"	1.25"
43.653.58.463	SCAT40 x SLN 1/2" - 4.63" DualDRIVE	4.63"	1/2"	1.25"
43.653.61.300	SCAT40 x SLN 5/8" - 3" DualDRIVE	3"	5/8"	1.5"
43.653.61.375	SCAT40 x SLN 5/8" - 3.75" DualDRIVE	3.75"	5/8"	1.5"
43.653.61.575	SCAT40 x SLN 5/8" - 5.75" DualDRIVE	5.75"	5/8"	1.5"
43.653.64.175	SCAT40 x SLN 3/4" - 1.75" DualDRIVE	1.75"	3/4"	1.75"
43.653.64.350	SCAT40 x SLN 3/4" - 3.5" DualDRIVE	3.5"	3/4"	1.75"
43.653.64.500	SCAT40 x SLN 3/4" - 5" DualDRIVE	5"	3/4"	1.75"
43.653.68.175	SCAT40 x SLN 1" - 1.75" DualDRIVE	1.75"	1"	2"
43.653.68.400	SCAT40 x SLN 1" - 4" DualDRIVE	4"	1"	2"
43.653.68.600	SCAT40 x SLN 1" - 6" DualDRIVE	6"	1"	2"
43.653.72.200	SCAT40 x SLN 1-1/4" - 2" DualDRIVE	2"	1-1/4"	2.5"
43.653.72.400	SCAT40 x SLN 1-1/4" - 4" DualDRIVE	4"	1-1/4"	2.5"
43.653.72.460	SCAT40 x SLN 1-1/4" - 4.6" DualDRIVE	4.6"	1-1/4"	2.5"
43.653.72.600	SCAT40 x SLN 1-1/4" - 6" DualDRIVE	6"	1-1/4"	2.5"
43.653.77.400	SCAT40 x SLN 1-1/2" - 4" DualDRIVE	4"	1-1/2"	2.5"
43.653.77.450	SCAT40 x SLN 1-1/2" - 4.5" DualDRIVE	4.5"	1-1/2"	2.5"

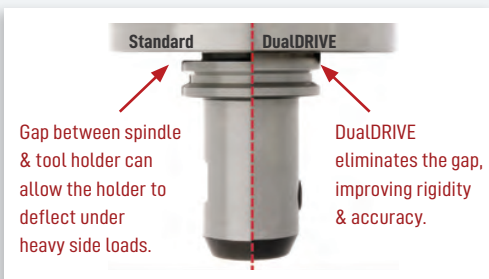

## DUAL-CONTACT SPINDLES

Dual-Contact is a spindle option offered by some machine tool builders where both the toolholder taper and the flange make contact with the spindle. The dual-contact provides increased rigidity and accuracy during heavy side loads.



pg. 94



pg. 229



pg. 236



pg. 238

# CAT40 END MILL HOLDERS - DUALDRIVE

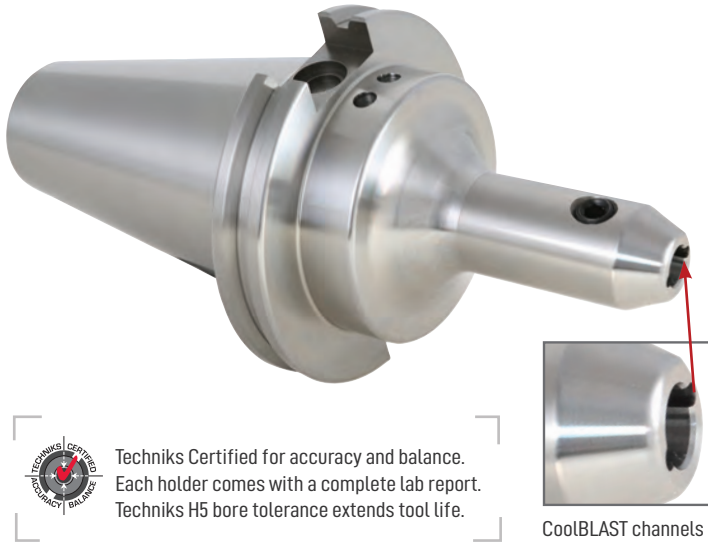

## FEATURES

- Compatible with standard and dual-contact spindles
- Dual-contact provides maximum rigidity for extreme applications
- Improved performance at high metal removal rates and when machining at extended lengths

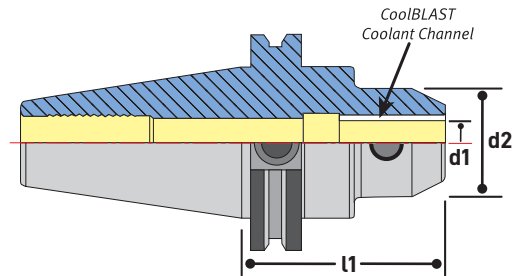

## CAT40 END MILL HOLDERS **DUALDRIVE WITH COOLBLAST**

Part No.	Description	l1	d1	d2
43.653.54.300B	SCAT40 x SLN 1/4" - 3" DualDRIVE with CoolBLAST	3"	1/4"	.78"
43.653.55.300B	SCAT40 x SLN 5/16" - 3" DualDRIVE with CoolBLAST	3"	5/16"	.88"
43.653.56.300B	SCAT40 x SLN 3/8" - 3" DualDRIVE with CoolBLAST	3"	3/8"	1"
43.653.57.300B	SCAT40 x SLN 7/16" - 3" DualDRIVE with CoolBLAST	3"	7/16"	1.13"
43.653.58.175B	SCAT40 x SLN 1/2" - 1.75" DualDRIVE with CoolBLAST	1.75"	1/2"	1.25"
43.653.58.250B	SCAT40 x SLN 1/2" - 2.5" DualDRIVE with CoolBLAST	2.5"	1/2"	1.25"
43.653.58.300B	SCAT40 x SLN 1/2" - 3" DualDRIVE with CoolBLAST	3"	1/2"	1.25"
43.653.58.463B	SCAT40 x SLN 1/2" - 4.63" DualDRIVE with CoolBLAST	4.63"	1/2"	1.25"
43.653.61.175B	SCAT40 x SLN 5/8" - 1.75" DualDRIVE with CoolBLAST	1.75"	5/8"	1.5"
43.653.61.300B	SCAT40 x SLN 5/8" - 3" DualDRIVE with CoolBLAST	3"	5/8"	1.5"
43.653.61.375B	SCAT40 x SLN 5/8" - 3.75" DualDRIVE with CoolBLAST	3.75"	5/8"	1.5"
43.653.61.575B	SCAT40 x SLN 5/8" - 5.75" DualDRIVE with CoolBLAST	5.75"	5/8"	1.5"
43.653.64.175B	SCAT40 x SLN 3/4" - 1.75" DualDRIVE with CoolBLAST	1.75"	3/4"	1.75"
43.653.64.350B	SCAT40 x SLN 3/4" - 3.5" DualDRIVE with CoolBLAST	3.5"	3/4"	1.75"
43.653.64.500B	SCAT40 x SLN 3/4" - 5" DualDRIVE with CoolBLAST	5"	3/4"	1.75"
43.653.68.175B	SCAT40 x SLN 1" - 1.75" DualDRIVE with CoolBLAST	1.75"	1"	2"
43.653.68.400B	SCAT40 x SLN 1" - 4" DualDRIVE with CoolBLAST	4"	1"	2"
43.653.72.400B	SCAT40 x SLN 1-1/4" - 4" DualDRIVE with CoolBLAST	4"	1-1/4"	2.5"



Stubby length



Techniks Certified for accuracy and balance. Each holder comes with a complete lab report. Techniks H5 bore tolerance extends tool life.

## FEATURES

- H5 bore tolerance for improved concentricity and tool life
- Taper ground to AT3 specification for maximum spindle contact
- Balanced to 15,000 RPM at G6.3

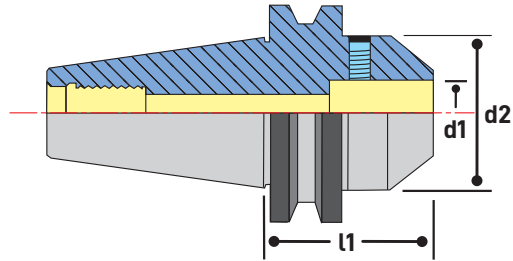

## CAT50 END MILL HOLDERS **STUBBY LENGTH**

Part No.	Description	l1	d1	d2
22931-2 1/2	CAT50 x SLN 1/4" - 2.5"	2.5"	1/4"	.78"
22935-2 1/2	CAT50 x SLN 3/8" - 2.5"	2.5"	3/8"	1"
22937-2 5/8	CAT50 x SLN 1/2" - 2.67"	2.67"	1/2"	1.5"
22939-9/16-1.44	CAT50 x SLN 9/16" - 1.44"	1.44"	9/16"	1.5"
22939-9/16-3	CAT50 x SLN 9/16" - 3"	3"	9/16"	1.5"
22939-1.44	CAT50 x SLN 5/8" - 1.44"	1.44"	5/8"	1.5"
22941-1.44	CAT50 x SLN 3/4" - 1.44"	1.44"	3/4"	1.75"
22945-2.62	CAT50 x SLN 1" - 2.62"	2.62"	1"	2"
22947-2.62	CAT50 x SLN 1-1/4" - 2.62"	2.62"	1-1/4"	2.5"
22949-2	CAT50 x SLN 1-1/2" - 2"	2"	1-1/2"	2.75"

### Techniks H5 Bore Tolerance Extends Tool Life 60%

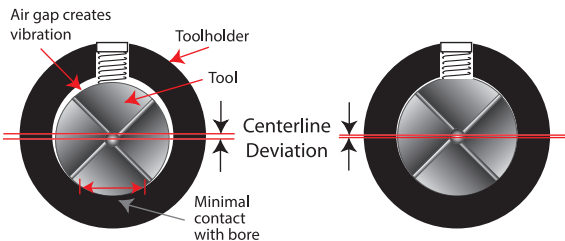

Others T.I.R.  
.0008"

TECHNIKS  
.0002"



All Techniks end mill holder bores are manufactured to meet or exceed the H5 specification.

H5 is an extremely accurate bore I.D. and provides improved T.I.R. for extended cutting tool life.



pg. 94



pg. 229



pg. 236



pg. 238

# CAT50 END MILL HOLDERS



Techniks Certified for accuracy and balance.  
Each holder comes with a complete lab report.  
Techniks H5 bore tolerance extends tool life.

## FEATURES

- H5 bore tolerance for improved concentricity and tool life
- Taper ground to AT3 specification for maximum spindle contact
- Balanced to 15,000 RPM at G6.3

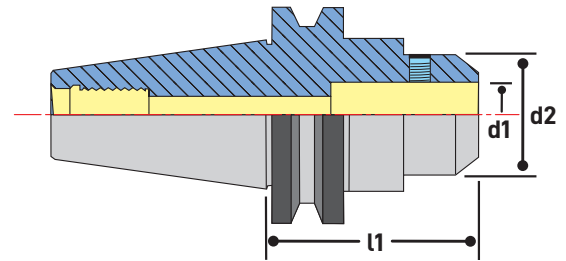

## CAT50 END MILL HOLDERS INCH & METRIC

Part No.	Description	l1	d1	d2
22931	CAT50 x SLN 1/4" - 4"	4"	1/4"	.78"
22933	CAT50 x SLN 5/16" - 4"	4"	5/16"	.88"
22935	CAT50 x SLN 3/8" - 4"	4"	3/8"	1"
22937	CAT50 x SLN 1/2" - 4"	4"	1/2"	1.25"
22939-3	CAT50 x SLN 5/8" - 3"	3"	5/8"	1.5"
22939	CAT50 x SLN 5/8" - 4"	4"	5/8"	1.5"
22941-3	CAT50 x SLN 3/4" - 3"	3"	3/4"	1.75"
22941	CAT50 x SLN 3/4" - 4"	4"	3/4"	1.75"
22943	CAT50 x SLN 7/8" - 4"	4"	7/8"	1.88"
22945	CAT50 x SLN 1" - 4"	4"	1"	2"
22947	CAT50 x SLN 1-1/4" - 4.6"	4.6"	1-1/4"	2.5"
22949	CAT50 x SLN 1-1/2" - 4.6"	4.6"	1-1/2"	2.5"
22981	CAT50 x SLN 6mm - 101.6mm	101.6mm	6mm	25mm
22983	CAT50 x SLN 8mm - 101.6mm	101.6mm	8mm	28mm
22985	CAT50 x SLN 10mm - 101.6mm	101.6mm	10mm	35mm
22987	CAT50 x SLN 12mm - 101.6mm	101.6mm	12mm	42mm
22989	CAT50 x SLN 16mm - 101.6mm	101.6mm	16mm	48mm
22990	CAT50 x SLN 20mm - 76.2mm	76.2mm	20mm	52mm
22993	CAT50 x SLN 25mm - 101.6mm	101.6mm	25mm	65mm
22996	CAT50 x SLN 32mm - 16.84mm	116.84mm	32mm	72mm



# CAT50 END MILL HOLDERS

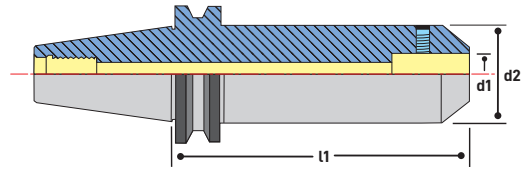

## CAT50 END MILL HOLDER EXTENDED LENGTH

Part No.	Description	l1	d1	d2
22931-8	CAT50 x SLN 1/4" - 8"	8"	1/4"	.78"
22935-6	CAT50 x SLN 3/8" - 6"	6"	3/8"	1"
22935-8	CAT50 x SLN 3/8" - 8"	8"	3/8"	1"
22937-6	CAT50 x SLN 1/2" - 6"	6"	1/2"	1.25"
22937-8	CAT50 x SLN 1/2" - 8"	8"	1/2"	1.25"
22939-6	CAT50 x SLN 5/8" - 6"	6"	5/8"	1.5"
22939-8	CAT50 x SLN 5/8" - 8"	8"	5/8"	1.5"
22941-5.75	CAT50 x SLN 3/4" - 5.75"	5.75"	3/4"	1.75"
22941-6	CAT50 x SLN 3/4" - 6"	6"	3/4"	1.75"
22941-8	CAT50 x SLN 3/4" - 8"	8"	3/4"	1.75"
22943-6	CAT50 x SLN 7/8" - 6"	6"	7/8"	1.88"
22943-8	CAT50 x SLN 7/8" - 8"	8"	7/8"	1.88"
22945-6	CAT50 x SLN 1" - 6"	6"	1"	2"
22946-8	CAT50 x SLN 1" - 8"	8"	1"	2"
22947-6	CAT50 x SLN 1-1/4" - 6"	6"	1-1/4"	2.5"
22947-8	CAT50 x SLN 1-1/4" - 8"	8"	1-1/4"	2.5"
22951	CAT50 x SLN 2" - 6"	6"	2"	3.75"



30% more rigidity using taper design.

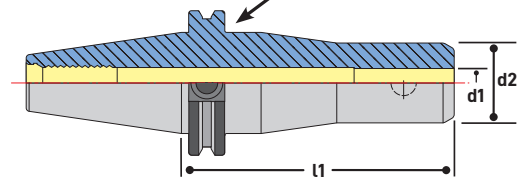

## CAT50 END MILL HOLDERS RIGID REACH

Part No.	Description	l1	d1	d2
22931-6.5T	CAT50 x SLN 1/4" - 6.5"	6.5"	1/4"	.78"
22931-10T	CAT50 x SLN 1/4" - 10"	10"	1/4"	.78"
22935-6.5T	CAT50 x SLN 3/8" - 6.5"	6.5"	3/8"	1"
22935-10T	CAT50 x SLN 3/8" - 10"	10"	3/8"	1"
22937-6.5T	CAT50 x SLN 1/2" - 6.5"	6.5"	1/2"	1.38"
22937-10T	CAT50 x SLN 1/2" - 10"	10"	1/2"	1.38"
22939-7.25T	CAT50 x SLN 5/8" - 7.25"	7.25"	5/8"	1.5"
22939-10T	CAT50 x SLN 5/8" - 10"	10"	5/8"	1.5"
22941-7.25T	CAT50 x SLN 3/4" - 7.25"	7.25"	3/4"	1.75"
22941-10T	CAT50 x SLN 3/4" - 10"	10"	3/4"	1.75"
22945-8T	CAT50 x SLN 1" - 8"	8"	1"	2"
22945-10T	CAT50 x SLN 1" - 10"	10"	1"	2"
22947-10T	CAT50 x SLN 1-1/4" - 10"	10"	1-1/4"	2.5"



pg. 94



pg. 229



pg. 236



pg. 238

# CAT50 END MILL HOLDERS - COOLBLAST

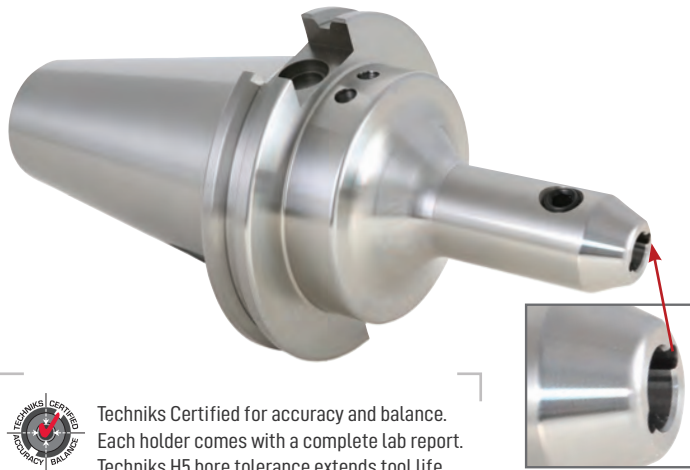

Techniks Certified for accuracy and balance. Each holder comes with a complete lab report. Techniks H5 bore tolerance extends tool life.

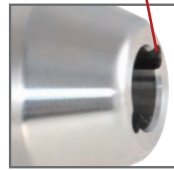

CoolBLAST channels

## FEATURES

- Coolant channels in the bore direct coolant precisely to the cutting edge
- Effective removal of chips for faster feed rates
- Through spindle and DIN-B coolant enabled

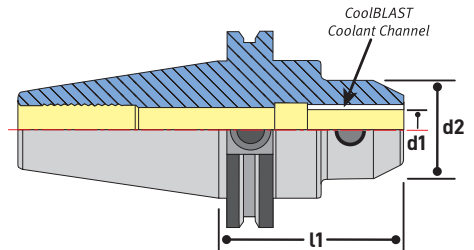

## CAT50 END MILL HOLDERS COOLBLAST

Part No.	Description	l1	d1	d2
22931-2.5B	CAT50 x SLN 1/4" - 2.5"	2.5"	1/4"	.78"
22931B	CAT50 x SLN 1/4" - 4"	4"	1/4"	.78"
22931-6B	CAT50 x SLN 1/4" - 6"	6"	1/4"	.78"
22931-8B	CAT50 x SLN 1/4" - 8"	8"	1/4"	.78"
22935-2.5B	CAT50 x SLN 3/8" - 2.5"	2.5"	3/8"	1"
22935B	CAT50 x SLN 3/8" - 4"	4"	3/8"	1"
22935-6B	CAT50 x SLN 3/8" - 6"	6"	3/8"	1"
22935-8B	CAT50 x SLN 3/8" - 8"	8"	3/8"	1"
22937-2.625B	CAT50 x SLN 1/2" - 2.62"	2.62"	1/2"	1.25"
22937B	CAT50 x SLN 1/2" - 4"	4"	1/2"	1.25"
22937-6B	CAT50 x SLN 1/2" - 6"	6"	1/2"	1.25"
22937-8B	CAT50 x SLN 1/2" - 8"	8"	1/2"	1.25"
22939-3B	CAT50 x SLN 5/8" - 3"	3"	5/8"	1.5"
22939B	CAT50 x SLN 5/8" - 4"	4"	5/8"	1.5"
22939-6B	CAT50 x SLN 5/8" - 6"	6"	5/8"	1.5"

Part No.	Description	l1	d1	d2
22941-1.44B	CAT50 x SLN 3/4" - 1.44"	1.44"	3/4"	1.75"
22941-3B	CAT50 x SLN 3/4" - 3"	3"	3/4"	1.75"
22941B	CAT50 x SLN 3/4" - 4"	4"	3/4"	1.75"
22941-6B	CAT50 x SLN 3/4" - 6"	6"	3/4"	1.75"
22941-8B	CAT50 x SLN 3/4" - 8"	8"	3/4"	1.75"
22943-6B	CAT50 x SLN 7/8" - 6"	6"	7/8"	1.88"
22943-8B	CAT50 x SLN 7/8" - 8"	8"	7/8"	2"
22945B	CAT50 x SLN 1" - 4"	4"	1"	2"
22945-6B	CAT50 x SLN 1" - 6"	6"	1"	2"
22946-8B	CAT50 x SLN 1" - 8"	8"	1"	2"
22947-2.62B	CAT50 x SLN 1-1/4" - 2.62"	2.62"	1-1/4"	2.5"
22947B	CAT50 x SLN 1-1/4" - 4.6"	4.6"	1-1/4"	2.5"
22947-6B	CAT50 x SLN 1-1/4" - 6"	6"	1-1/4"	2.5"
22947-8B	CAT50 x SLN 1-1/4" - 8"	8"	1-1/4"	2.5"
22949B	CAT50 x SLN 1-1/2" - 4.6"	4.6"	1-1/2"	2.5"
22951B	CAT50 x SLN 2" - 6"	6"	2"	3.75"

## CAT50 END MILL HOLDERS RIGID REACH WITH COOLBLAST

Part No.	Description	l1	d1	d2
22931-10BT	CAT50 x SLN 1/4" - 10" with CoolBLAST	1/4"	10"	.78"
22935-10BT	CAT50 x SLN 3/8" - 10" with CoolBLAST	3/8"	10"	1"
22937-10BT	CAT50 x SLN 1/2" - 10" with CoolBLAST	1/2"	10"	1.38"
22939-10BT	CAT50 x SLN 5/8" - 10" with CoolBLAST	5/8"	10"	1.5"
22941-10BT	CAT50 x SLN 3/4" - 10" with CoolBLAST	3/4"	10"	1.75"
22945-10BT	CAT50 x SLN 1" - 10" with CoolBLAST	1"	10"	2"
22947-10BT	CAT50 x SLN 1-1/4" - 10" with CoolBLAST	1-1/4"	10"	2.5"





 Techniks Certified for accuracy and balance. Each holder comes with a complete lab report. Techniks H5 bore tolerance extends tool life.

## FEATURES

- Through spindle and DIN-B coolant enabled
- H5 bore tolerance for improved concentricity and tool life
- Balanced to 15,000 RPM @ G6.3

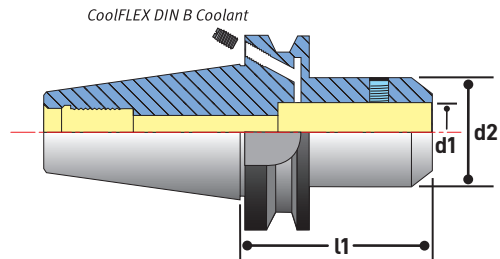

### Techniks H5 Bore Tolerance Extends Tool Life 60%

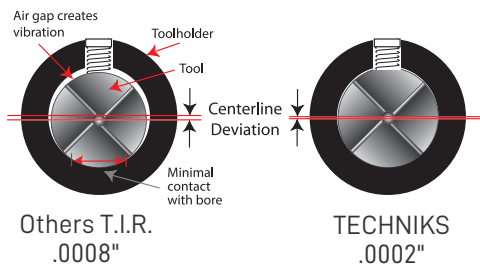

## COOLFLEX FEATURE

CoolFLEX holders are factory set for coolant-thru spindle. Remove the stop screws for DIN B coolant-thru flange.

Part No.	Description
HSA-6-6	50 taper DIN B screw

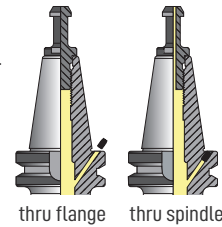

## CAT50 END MILL HOLDERS COOLFLEX

Part No.	Description	l1	d1	d2
22931F	CAT50 x SLN 1/4" - 4"	4"	1/4"	.78"
22935F	CAT50 x SLN 3/8" - 4"	4"	1/4"	1"
22937F	CAT50 x SLN 1/2" - 4"	4"	1/2"	1.25"
22937-6F	CAT50 x SLN 1/2" - 6"	6"	1/2"	1.25"
22937-8F	CAT50 x SLN 1/2" - 8"	8"	1/2"	1.25"
22939F	CAT50 x SLN 5/8" - 4"	4"	5/8"	1.5"
22941-3F	CAT50 x SLN 3/4" - 3"	3"	3/4"	1.75"
22941F	CAT50 x SLN 3/4" - 4"	4"	3/4"	1.75"
22945-2.62F	CAT50 x SLN 1" - 2.62"	2.62"	1"	2"
22945F	CAT50 x SLN 1" - 4"	4"	1"	2"
22947F	CAT50 x SLN 1-1/4" - 4.6"	4.6"	1-1/4"	2.5"
22949F	CAT50 x SLN 1-1/2" - 4.6"	4.6"	1-1/2"	2.5"



pg. 94



pg. 229



pg. 236



pg. 238

# CAT50 END MILL HOLDERS - DUALDRIVE

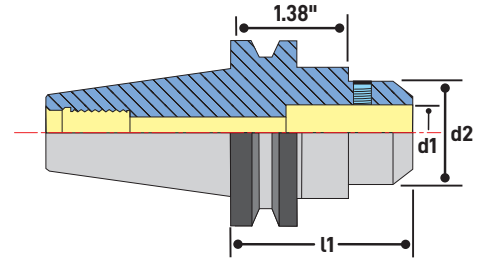

## CAT50 END MILL HOLDERS **DUALDRIVE**

Part No.	Description	l1	d1	d2
44.653.52.600	SCAT50 x SLN 1/8" - 6" DualDRIVE	6"	1/8"	.75"
44.653.54.400	SCAT50 x SLN 1/4" - 4" DualDRIVE	4"	1/4"	.79"
44.653.55.400	SCAT50 x SLN 5/16" - 4" DualDRIVE	4"	5/16"	.88"
44.653.56.400	SCAT50 x SLN 3/8" - 4" DualDRIVE	4"	3/8"	.88"
44.653.56.800	SCAT50 x SLN 3/8" - 8" DualDRIVE	8"	3/8"	.88"
44.653.58.400	SCAT50 x SLN 1/2" - 4" DualDRIVE	4"	1/2"	1.25"
44.653.58.600	SCAT50 x SLN 1/2" - 6" DualDRIVE	6"	1/2"	1.25"
44.653.58.800	SCAT50 x SLN 1/2" - 8" DualDRIVE	8"	1/2"	1.5"
44.653.61.400	SCAT50 x SLN 5/8" - 4" DualDRIVE	4"	5/8"	1.5"
44.653.61.600	SCAT50 x SLN 5/8" - 6" DualDRIVE	6"	5/8"	1.5"
44.653.61.800	SCAT50 x SLN 5/8" - 8" DualDRIVE	8"	5/8"	1.5"
44.653.64.144	SCAT50 x SLN 3/4" - 1.44" DualDRIVE	1.44"	3/4"	1.75"
44.653.64.300	SCAT50 x SLN 3/4" - 3" DualDRIVE	3"	3/4"	1.75"
44.653.64.400	SCAT50 x SLN 3/4" - 4" DualDRIVE	4"	3/4"	1.75"
44.653.64.600	SCAT50 x SLN 3/4" - 6" DualDRIVE	6"	3/4"	1.75"
44.653.64.800	SCAT50 x SLN 3/4" - 8" DualDRIVE	8"	3/4"	1.75"
44.653.68.262	SCAT50 x SLN 1" - 2.62" DualDRIVE	2.62"	1"	2.484"
44.653.68.400	SCAT50 x SLN 1" - 4" DualDRIVE	4"	1"	2"
44.653.68.600	SCAT50 x SLN 1" - 6" DualDRIVE	6"	1"	2.484"
44.653.68.800	SCAT50 x SLN 1" - 8" DualDRIVE	8"	1"	2"
44.653.72.262	SCAT50 x SLN 1-1/4" - 2.62" DualDRIVE	2.62"	1-1/4"	2.75"
44.653.72.460	SCAT50 x SLN 1-1/4" - 4.6" DualDRIVE	4.6"	1-1/4"	2.5"
44.653.72.600	SCAT50 x SLN 1-1/4" - 6" DualDRIVE	6"	1-1/4"	2.75"
44.653.72.800	SCAT50 x SLN 1-1/4" - 8" DualDRIVE	8"	1-1/4"	2.5"
44.653.77.460	SCAT50 x SLN 1-1/2" - 4.6" DualDRIVE	4.6"	1-1/2"	2.5"
44.653.77.800	SCAT50 x SLN 1-1/2" - 8" DualDRIVE	8"	1-1/2"	2.5"
44.653.86.600	SCAT50 x SLN 2" - 6" DualDRIVE	6"	2"	3.75"

## CAT50 END MILL HOLDERS **DUALDRIVE WITH COOLBLAST**

Part No.	Description	L	d1	d2
44.653.58.400B	SCAT50 x SLN 1/2" - 4" DualDRIVE with CoolBLAST	4"	1/2"	1.25"
44.653.61.400B	SCAT50 x SLN 5/8" - 4" DualDRIVE with CoolBLAST	4"	5/8"	1.5"
44.653.64.300B	SCAT50 x SLN 3/4" - 3" DualDRIVE with CoolBLAST	3"	3/4"	1.75"



# HSK63A / 63F END MILL HOLDERS



Techniks Certified for accuracy and balance. Each holder comes with a complete lab report. Techniks H5 bore tolerance extends tool life.

## FEATURES

- H5 bore tolerance for improved concentricity and tool life
- Balance to 15,000 RPM @ G6.3
- Coolant tubes for through-spindle coolant

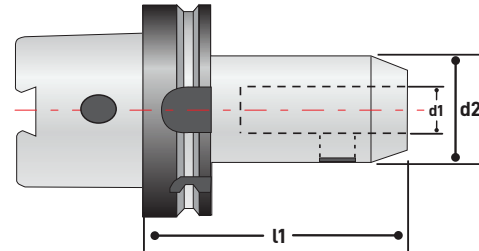

## HSK63A END MILL HOLDERS

Part No.	Description	l1	d1	d2
32946	HSK63A x SLN 1/8" - 3"	3"	1/8"	.68"
32946-5	HSK63A x SLN 1/8" - 5"	5"	1/8"	.68"
32947	HSK63A x SLN 3/16" - 3"	3"	3/16"	.68"
32947-5	HSK63A x SLN 3/16" - 5"	5"	3/16"	.68"
32948	HSK63A x SLN 1/4" - 3"	3"	1/4"	.78"
32948-5	HSK63A x SLN 1/4" - 5"	5"	1/4"	.78"
32952	HSK63A x SLN 3/8" - 3"	3"	3/8"	1"
32952-5	HSK63A x SLN 3/8" - 5"	5"	3/8"	1"
32954	HSK63A x SLN 1/2" - 3"	3"	1/2"	1.38"
32954-4	HSK63A x SLN 1/2" - 4"	4"	1/2"	.78"
32954-5	HSK63A x SLN 1/2" - 5"	5"	1/2"	1.38"
32956	HSK63A x SLN 5/8" - 3.75"	3.75"	5/8"	1.63"
32956-5	HSK63A x SLN 5/8" - 5"	5"	5/8"	1.63"
32958	HSK63A x SLN 3/4" - 3.75"	3.75"	3/4"	1.75"
32958-4	HSK63A x SLN 3/4" - 4"	4"	3/4"	1.75"
32958-6	HSK63A x SLN 3/4" - 6"	6"	3/4"	1.75"
32962	HSK63A x SLN 1" - 3.75"	3.75"	1"	2"
32964	HSK63A x SLN 1-1/4" - 4.25"	4.25"	1-1/4"	2.5"

## HSK63F END MILL HOLDERS

Part No.	Description	l1	d1	d2
32958-4-F	HSK63F x SLN 3/4" - 4"	4"	3/4"	1.75"
32962-4-F	HSK63F x SLN 1" - 4"	4"	1"	2"
32838-4-F	HSK63F x SLN 25mm - 101.6mm	101.6mm	25mm	65mm
32840-F	HSK63F x SLN 32mm - 110mm	110mm	32mm	72mm



pg. 94



pg. 229



pg. 236



pg. 238

# HSK END MILL HOLDERS



Technics Certified for accuracy and balance. Each holder comes with a complete lab report. Technics H5 bore tolerance extends tool life.

## FEATURES

- H5 bore tolerance for improved concentricity and tool life
- Balance to 15,000 RPM @ G6.3
- Use coolant tubes for through-spindle coolant

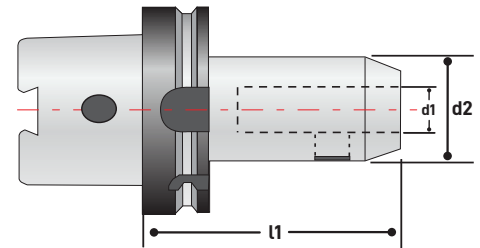

## HSK100A END MILL HOLDERS

Part No.	Description	l1	d1	d2
32978	HSK100A x SLN 1/4" - 3"	3"	1/4"	.78"
32978-6	HSK100A x SLN 1/4" - 6"	6"	1/4"	.78"
32982	HSK100A x SLN 3/8" - 3"	3"	3/8"	1"
32982-6	HSK100A x SLN 3/8" - 6"	6"	3/8"	1"
32984	HSK100A x SLN 1/2" - 3.25"	3.25"	1/2"	1.38"
32984-6	HSK100A x SLN 1/2" - 6"	6"	1/2"	1.25"
32986	HSK100A x SLN 5/8" - 3.75"	3.75"	5/8"	1.63"
32986-6	HSK100A x SLN 5/8" - 6"	6"	5/8"	1.25"
32988	HSK100A x SLN 3/4" - 3.75"	3.75"	3/4"	1.75"
32988-6	HSK100A x SLN 3/4" - 6"	6"	3/4"	1.75"
32992	HSK100A x SLN 1" - 4.25"	4.25"	1"	2"
32992-6	HSK100A x SLN 1" - 6"	6"	1"	2"
32994	HSK100A x SLN 1-1/4" - 4.25"	4.25"	1-1/4"	2.5"
32994-6	HSK100A x SLN 1-1/4" - 6"	6"	1-1/4"	2.5"
32996	HSK100A x SLN 1-1/2" - 4.5"	4.5"	1-1/2"	2.75"
32996-6	HSK100A x SLN 1-1/2" - 6"	6"	1-1/2"	2.5"
32998	HSK100A x SLN 2" - 5.5"	5.5"	2"	3.75"
32998-6	HSK100A x SLN 2" - 6"	6"	2"	3.75"



# BT30 END MILL HOLDERS

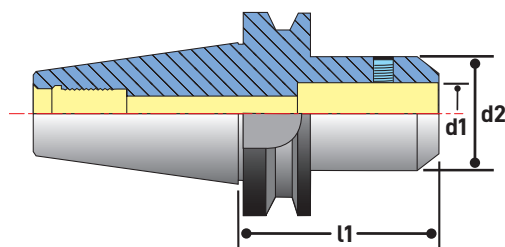

## BT30 END MILL HOLDERS

Part No.	Description	l1	d1	d2
17130-1/8	BT30 x SLN 1/8" - 2.36"	2.36"	1/8"	.68"
17130-3/16	BT30 x SLN 3/16" - 2.36"	2.36"	3/16"	.68"
17130-1/4	BT30 x SLN 1/4" - 2.36"	2.36"	1/4"	.78"
17130-5/16	BT30 x SLN 5/16" - 2.36"	2.36"	5/16"	.88"
17130-3/8	BT30 x SLN 3/8" - 2.36"	2.36"	3/8"	1"
17130-7/16	BT30 x SLN 7/16" - 2.36"	2.36"	7/16"	1.12"
17130-1/2	BT30 x SLN 1/2" - 2.36"	2.36"	1/2"	1.25"
17130-9/16	BT30 x SLN 9/16" - 2.36"	9/16"	2.36"	1.25"
17130-5/8	BT30 x SLN 5/8" - 2.36"	2.36"	5/8"	1.5"
17130-3/4	BT30 x SLN 3/4" - 2.36"	2.36"	3/4"	1.75"

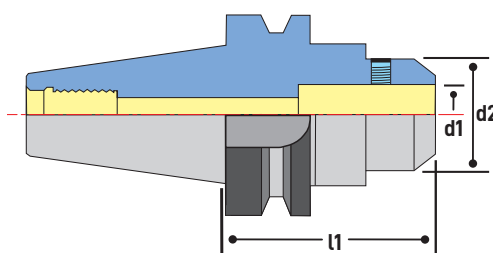

## BT30 END MILL HOLDERS **DUALDRIVE**

Part No.	Description	l1	d2	d1
25.653.52.250	SBT30 x SLN 1/8" - 2.5" DualDRIVE	2.5"	1/8"	.68"
25.653.53.250	SBT30 x SLN 3/16" - 2.5" DualDRIVE	2.5"	3/16"	.68"
25.653.54.250	SBT30 x SLN 1/4" - 2.5" DualDRIVE	2.5"	1/4"	.78"
25.653.56.250	SBT30 x SLN 3/8" - 2.5" DualDRIVE	2.5"	3/8"	1"
25.653.57.250	SBT30 x SLN 7/16" - 2.5" DualDRIVE	2.5"	7/16"	1.12"
25.653.58.250	SBT30 x SLN 1/2" - 2.5" DualDRIVE	2.5"	1/2"	1.25"
25.653.61.250	SBT30 x SLN 5/8" - 2.5" DualDRIVE	2.5"	5/8"	1.5"
25.653.64.300	SBT30 x SLN 3/4" - 3" DualDRIVE	3"	3/4"	1.75"



pg. 94



pg. 229



pg. 236



pg. 238

# BT40 END MILL HOLDERS



Techniks Certified for accuracy and balance.  
Each holder comes with a complete lab report.  
Techniks H5 bore tolerance extends tool life.

## FEATURES

- H5 bore tolerance for improved concentricity and tool life
- Taper ground to AT3 specification for maximum spindle contact
- Balanced to 15,000 RPM at G6.3

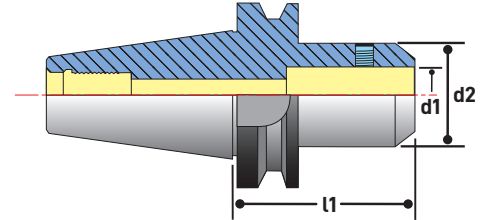

## BT40 END MILL HOLDERS INCH & METRIC

Part No.	Description	l1	d1	d2
17140-1/8	BT40 x SLN 1/8" - 2.5"	2.5"	1/8"	.68"
17140-3/16	BT40 x SLN 3/16" - 2.5"	2.5"	3/16"	.68"
17140-1/4	BT40 x SLN 1/4" - 2.5"	2.5"	1/4"	.78"
17140-5/16	BT40 x SLN 5/16" - 2.5"	2.5"	5/16"	.88"
17140-3/8	BT40 x SLN 3/8" - 2.5"	2.5"	3/8"	1"
17140-7/16	BT40 x SLN 7/16" - 2.5"	2.5"	7/16"	1.1"
17140-1/2	BT40 x SLN 1/2" - 2.5"	2.5"	1/2"	1.25"
17140-5/8	BT40 x SLN 5/8" - 2.5"	2.5"	5/8"	1.5"
17140-3/4	BT40 x SLN 3/4" - 2.5"	2.5"	3/4"	1.75"
17140-1	BT40 x SLN 1" - 3.56"	3.56"	1"	2"
17140-1-1/4	BT40 x SLN 1-1/4" - 3.56"	3.56"	1-1/4"	2.5"
17140-1-1/2	BT40 x SLN 1-1/2" - 3.56"	3.56"	1-1/2"	2.5"
17131	BT40 x SLN 6mm - 50mm	50mm	6mm	25mm
17132	BT40 x SLN 8mm - 50mm	50mm	8mm	28mm
17133	BT40 x SLN 10mm - 63mm	63mm	10mm	35mm
17134	BT40 x SLN 12mm - 63mm	63mm	12mm	42mm
17135	BT40 x SLN 16mm - 63mm	63mm	16mm	48mm
17135-18	BT40 x SLN 18mm - 63mm	63mm	18mm	50mm
17136	BT40 x SLN 20mm - 63mm	63mm	20mm	52mm
17137	BT40 x SLN 25mm - 100mm	100mm	25mm	65mm
17138	BT40 x SLN 32mm - 100mm	100mm	32mm	72mm



# BT40 END MILL HOLDERS



pg. 94



pg. 229



pg. 236



pg. 238



Extended length



Techniks Certified for accuracy and balance. Each holder comes with a complete lab report. Techniks H5 bore tolerance extends tool life.

## FEATURES

- H5 bore tolerance for improved concentricity and tool life
- Taper ground to AT3 specification for maximum spindle contact
- Balanced to 15,000 RPM at G6.3

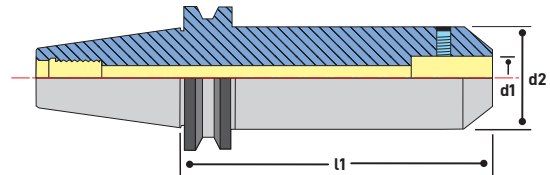

## BT40 END MILL HOLDERS EXTENDED LENGTH

Part No.	Description	l1	d1	d2
17140-1/8-4	BT40 x SLN 1/8" - 4"	4"	1/8"	.68"
17140-3/16-4	BT40 x SLN 3/16" - 4"	4"	3/16"	.68"
17140-1/4-4	BT40 x SLN 1/4" - 4"	4"	1/4"	.78"
17140-3/8-4	BT40 x SLN 3/8" - 4"	4"	3/8"	1"
17140-1/2-4	BT40 x SLN 1/2" - 4"	4"	1/2"	1.25"
17140-5/8-4	BT40 x SLN 5/8" - 4"	4"	5/8"	1.5"
17140-3/4-4	BT40 x SLN 3/4" - 4"	4"	3/4"	1.75"
17140-7/8-5	BT40 x SLN 7/8" - 5"	5"	7/8"	1.75"
17140-1-5	BT40 x SLN 1" - 5"	5"	1"	2"



Rigid Reach



30% more rigidity using taper design.

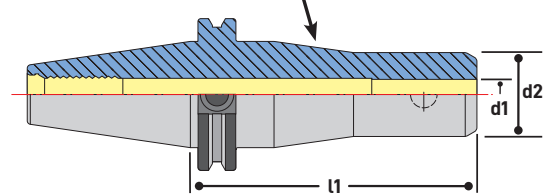

Our Rigid Reach End Mill holders are great for machining in tight areas or at extended length where tolerance is important. The tapered design improves rigidity and overall cutting performance.

## BT40 END MILL HOLDERS RIGID REACH

Part No.	Description	l1	d1	d2
17140-1/8-5.0-RR	BT40 x SLN 1/8" - 5"	5"	1/8"	.78"
17140-3/16-4.72-RR	BT40 x SLN 3/16" - 4.72"	4.72"	3/16"	.78"
17140-1/4-4.72-RR	BT40 x SLN 1/4" - 4.72"	4.72"	1/4"	.78"
17140-3/8-4.72-RR	BT40 x SLN 3/8" - 4.72"	4.72"	3/8"	1"
17140-1/2-4.72-RR	BT40 x SLN 1/2" - 4.72"	4.72"	1/2"	1.38"
17140-3/4-6-RR	BT40 x SLN 3/4" - 6"	6"	3/4"	1.38"



pg. 94



pg. 229



pg. 236



pg. 238

# BT40 / BT50 END MILL HOLDERS



Techniks Certified for accuracy and balance. Each holder comes with a complete lab report. Techniks H5 bore tolerance extends tool life.

## FEATURES

- H5 bore tolerance for improved concentricity and tool life
- Taper ground to AT3 specification for maximum spindle contact
- Balanced to 15,000 RPM at G6.3

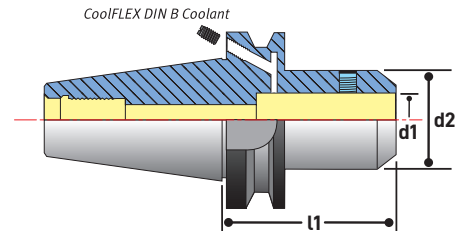

## BT40 END MILL HOLDERS **COOLFLEX**

Part No.	Description	l1	d1	d2
17140-1/4F	BT40 x SLN 1/4" - 2.5"	2.5"	1/4"	.78"
17140-3/8F	BT40 x SLN 3/8" - 2.5"	2.5"	3/8"	1"
17140-1/2F	BT40 x SLN 1/2" - 2.5"	2.5"	1/2"	1.25"
17140-5/8F	BT40 x SLN 5/8" - 2.5"	2.5"	5/8"	1.5"
17140-3/4F	BT40 x SLN 3/4" - 2.5"	2.5"	3/4"	1.75"
17140-1F	BT40 x SLN 1" - 3.56"	3.56"	1"	2"
17140-1-1/4F	BT40 x SLN 1-1/4" - 3.56"	3.56"	1-1/4"	2.5"



## BT50 END MILL HOLDERS

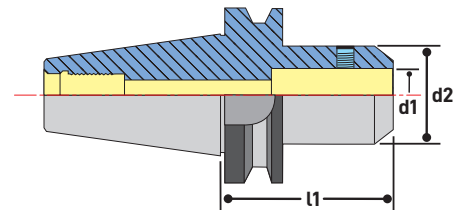

Part No.	Description	l1	d1	d2
17150-1/4	BT50 x SLN 1/4" - 3"	3"	1/4"	.78"
17150-3/8	BT50 x SLN 3/8" - 2.75"	2.75"	3/8"	1"
17150-1/2	BT50 x SLN 1/2" - 3"	3"	1/2"	1.25"
17150-5/8	BT50 x SLN 5/8" - 3"	3"	5/8"	1.5"
17150-3/4	BT50 x SLN 3/4" - 3"	3"	3/4"	1.75"
17150-1-4.5	BT50 x SLN 1" - 4.5"	4.5"	1"	2"
17150-1-6	BT50 x SLN 1" - 6"	6"	1"	2"
17150-1-1/4-4.5	BT50 x SLN 1.25" - 4.5"	4.5"	1.25"	2.5"
18593	BT50 x SLN 1.5" - 4.13"	4.13"	1.5"	2.5"



# REPLACEMENT SET SCREWS



pg. 94



pg. 229



pg. 236



pg. 238



## REPLACEMENT SET SCREWS

Please specify your bore I.D. (shank size) when ordering replacement lock screws to ensure correct replacement.

Part No.	Metric	Thread
17137-screw	18mm, 25mm	M18 x 2.0P
HSA-20-20	20mm, 32mm	M20 x 2.0P

Part No.	Fits EMH I.D.	Length	Torque	Stubby Body	Thread
22954-5/16	1/8"	5/16" (.3125)	10 ft/lbs	-	6-32
22955-1/4	3/16"	1/4" (.25)	3 ft/lbs	-	8-32
22956-5/16	1/4"	5/16" (.3125)	5 ft/lbs	-	1/4-28
22957-1/4	3/8"	1/4" (.25)	15 ft/lbs	22915-1.75	5/16-24
22957-5/16	5/16"	5/16" (.3125)	14 ft/lbs	-	5/16-24
22958-5/16	3/8"	5/16" (.3125)	15 ft/lbs	-	3/8-24
22959-5/16	7/16"	5/16" (.3125)	16 ft/lbs	-	7/16-20
22959-3/8	1/2"	3/8" (.375)	20 ft/lbs	-	7/16-20
22959-7/16	5/8"	7/16" (.4375)	40 ft/lbs	-	1/2-20
22961-9/32	1-1/4"	9/32" (.2813)	110 ft/lbs	22927A-2	5/8-18
22961-7/16	1"	7/16" (.4375)	110 ft/lbs	22925A-1.75(F), 22923, 22925-3	5/8-18
22961-1/2	3/4"	1/2" (.5)	70 ft/lbs	-	5/8-18
22961-1/2	7/8"	1/2" (.5)	70 ft/lbs	-	5/8-18
22962-1/2	1-1/2"	1/2" (.5)	110 ft/lbs	22925	3/4-16
22961-5/8	1-1/4"	5/8" (.625)	110 ft/lbs	22947-2.62	5/8-18



# TECHNIKS CERTIFIED SHRINKFIT TOOLS

## QUALITY & PERFORMANCE GUARANTEED



**SFS12 MODULAR SHRINKFIT SYSTEM**

- Powerful internal drawbar design
- Ultra-slim modular adapters
- Coolant-thru capable

**SHRINKFIT ADAPTERS ARE MADE FROM H13 TOOL STEEL.**



**00450 SHRINKSTATION HEAT SHRINK MACHINE**

- Compact and powerful heat shrink machine
- Compatible with gauge lengths up to 22"
- Easy-to-use touch screen operation

The ShrinkSTATION is an ideal solution for job shops or manufacturing facilities that need a reliable shrink fit machine that can handle practically all sizes and types of toolholders and is affordable.



**COOLBLAST OR COOLFLEX DIN-B COOLANT THRU COMPATIBLE**

- 3-port coolant thru design
  - CoolBLAST with internal coolant ports
  - CoolFLEX DIN B coolant thru flange

Three coolant ports for increased volume & easier tool removal.

 Techniks Certified DualDRIVE ShrinkFIT holders for your dual-contact spindles.

**IT'S NOT JUST SHRINKFIT. IT'S SHRINKLOCKED!**

**PATENTED TTG-594 COATING FORMULA FOR UNBREAKABLE HOLDING FORCE.**



**SHRINK LOCKED™**  
WITH FORMULA TTG 594





# CAT40 SHRINKFIT HOLDERS



## FEATURES

- Maximum T.I.R. only 0.0001"
- Balanced 25,000 RPM at G2.5
- Coolant-thru stop screw included

 Techniks Certified ShrinkFIT holders are individually measured, tested and verified to meet or exceed our published specifications.

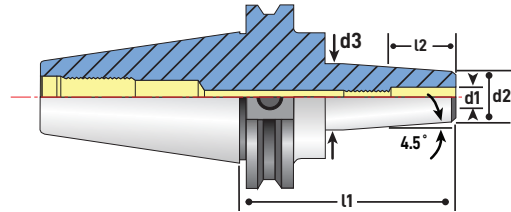

## CAT40 SHRINKFIT HOLDERS INCH

Part No.	Description	d1	d2	d3	l1	l2	stop screw thread	coolant stop screw
29002	CAT40 x 1/8" I.D. - 3.5"	1/8"	.36"	.63"	3.5"	.79"	-	-
29004	CAT40 x 1/8" I.D. - 5"	1/8"	.36"	.87"	5"	.79"	-	-
29006	CAT40 x 3/16" I.D. - 3.5"	3/16"	.43"	.70"	3.5"	.79"	M6 x 1.0P	16081C-20
29008	CAT40 x 3/16" I.D. - 5"	3/16"	.43"	.71"	5"	.79"	M6 x 1.0P	16081C-20
29010	CAT40 x 1/4" I.D. - 3"	1/4"	.71"	.94"	3"	1.42"	M5 x 0.8P	16080C-20
29011	CAT40 x 1/4" I.D. - 3.5"	1/4"	.71"	.94"	3.5"	1.42"	M5 x 0.8P	16080C-20
29013	CAT40 x 1/4" I.D. - 5"	1/4"	.71"	1.06"	5"	1.42"	M5 x 0.8P	16080C-20
29014	CAT40 x 1/4" I.D. - 6"	1/4"	.71"	1.37"	6"	1.42"	M5 x 0.8P	16080C-20
29016	CAT40 x 5/16" I.D. - 3.5"	5/16"	.79"	1.06"	3.5"	1.42"	M6 x 1.0P	16081C-20
29018	CAT40 x 5/16" I.D. - 5"	5/16"	.79"	1.06"	5"	1.42"	M6 x 1.0P	16081C-20
29020	CAT40 x 3/8" I.D. - 3"	3/8"	.94"	1.18"	3"	1.53"	M8 x 1.25P	16082C-20
29021	CAT40 x 3/8" I.D. - 3.75"	3/8"	.94"	1.26"	3.75"	1.53"	M8 x 1.25P	16082C-20
29023	CAT40 x 3/8" I.D. - 5"	3/8"	.94"	1.37"	5"	1.53"	M8 x 1.25P	16082C-20
29024	CAT40 x 3/8" I.D. - 6"	3/8"	.94"	1.37"	6"	1.53"	M8 x 1.25P	16082C-20
29025	CAT40 x 7/16" I.D. - 3"	7/16"	.94"	1.18"	3"	1.62"	M10 x 1.5P	16083C-20
29026	CAT40 x 1/2" I.D. - 3"	1/2"	1.10"	1.34"	3"	1.85"	M10 x 1.5P	16083C-20
29027	CAT40 x 1/2" I.D. - 3.75"	1/2"	1.10"	1.34"	3.75"	1.85"	M10 x 1.5P	16083C-20
29029	CAT40 x 1/2" I.D. - 5"	1/2"	1.10"	1.37"	5"	1.85"	M10 x 1.5P	16083C-20
29030	CAT40 x 1/2" I.D. - 6"	1/2"	1.10"	1.37"	6"	1.85"	M10 x 1.5P	16083C-20
29032	CAT40 x 5/8" I.D. - 3.75"	5/8"	1.06"	1.34"	3.75"	1.97"	M12 x 1.75P	16085C-20
29034	CAT40 x 3/4" I.D. - 3"	3/4"	1.42"	1.65"	3"	2.04"	M16 x 2.0P	16089C-20
29036	CAT40 x 3/4" I.D. - 4"	3/4"	1.42"	1.65"	4"	2.04"	M16 x 2.0P	16089C-20
29037	CAT40 x 3/4" I.D. - 5"	3/4"	1.26"	1.37"	5"	2.04"	M16 x 2.0P	16089C-20
29038	CAT40 x 3/4" I.D. - 6"	3/4"	1.26"	1.37"	6"	2.04"	M16 x 2.0P	16089C-20
29040	CAT40 x 1" I.D. - 3"	1"	1.81"	2.04"	3"	2.28"	M20 x 2.0P	16091C-20
29042	CAT40 x 1" I.D. - 4"	1"	1.81"	2.09"	4"	2.28"	M20 x 2.0P	16091C-20
29044	CAT40 x 1" I.D. - 6"	1"	1.81"	2.09"	6"	2.28"	M20 x 2.0P	16091C-20
29046	CAT40 x 1-1/4" I.D. - 4"	1-1/4"	1.81"	2.09"	4"	2.28"	M20 x 2.0P	16091C-20



pg. 119



pg. 115



pg. 229



pg. 236

# CAT40 SHRINKFIT HOLDERS

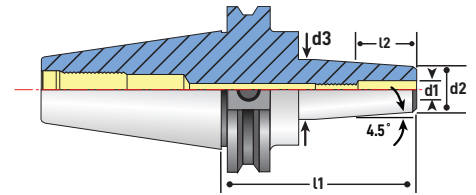

## CAT40 SHRINKFIT HOLDERS METRIC

Part No.	Description	d1	d2	d3	l1	l2	stop screw thread	coolant stop screw
29204	CAT40 x 4mm I.D. - 100mm	4mm	10mm	18.7mm	100mm	20mm	M6 x 1.0P	16081C-20
29206	CAT40 x 5mm I.D. - 100mm	5mm	16mm	22mm	100mm	20mm	M8 x 1.25P	16081C-20
29208	CAT40 x 6mm I.D. - 100mm	6mm	21mm	27mm	100mm	36mm	M5 x 0.8P	16080C-20
29210	CAT40 x 6mm I.D. - 150mm	6mm	21mm	27mm	150mm	36mm	M5 x 0.8P	16080C-20
29212	CAT40 x 8mm I.D. - 100mm	8mm	21mm	27mm	100mm	36mm	M6 x 1.0P	16081C-20
29214	CAT40 x 8mm I.D. - 150mm	8mm	21mm	27mm	150mm	36mm	M6 x 1.0P	16081C-20
29216	CAT40 x 10mm I.D. - 100mm	10mm	24mm	32mm	100mm	42mm	M8 x 1.25P	16082C-20
29218	CAT40 x 10mm I.D. - 150mm	10mm	24mm	32mm	150mm	42mm	M8 x 1.25P	16082C-20
29220	CAT40 x 12mm I.D. - 100mm	12mm	24mm	32mm	100mm	47mm	M10 x 1.5P	16083C-20
29222	CAT40 x 12mm I.D. - 150mm	12mm	24mm	32mm	150mm	47mm	M10 x 1.5P	16083C-20
29226	CAT40 x 14mm I.D. - 100mm	14mm	27mm	34mm	100mm	47mm	M10 x 1.5P	16083C-20
29228	CAT40 x 14mm I.D. - 152.4mm	14mm	27mm	34mm	152.4mm	47mm	M10 x 1.5P	16083C-20
29230	CAT40 x 16mm I.D. - 95.3mm	16mm	27mm	34mm	95.3mm	50mm	M12 x 1.75P	16085C-20
29232	CAT40 x 16mm I.D. - 100mm	16mm	27mm	34mm	100mm	50mm	M12 x 1.75P	16085C-20
29234	CAT40 x 16mm I.D. - 160mm	16mm	27mm	34mm	160mm	50mm	M12 x 1.75P	16085C-20
29236	CAT40 x 18mm I.D. - 100mm	18mm	33mm	42mm	100mm	50mm	M12 x 1.75P	16089C-20
29238	CAT40 x 20mm I.D. - 80mm	20mm	33mm	42mm	80mm	52mm	M16 x 2.0P	16089C-20
29240	CAT40 x 25mm I.D. - 101.6mm	25mm	44mm	53mm	101.6mm	58mm	M20 x 2.0P	16091C-20

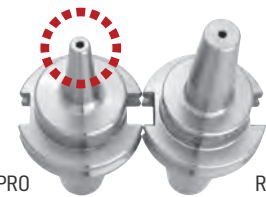

SlimPRO

Regular

Use SlimPRO holders where small nose diameter (d2) tooling is needed.

## CAT40 SHRINKFIT HOLDERS SLIMPRO

Part No.	Description	d1	d2	d3	l1	l2	stop screw thread	coolant stop screw
31528	CAT40 x 1/8" I.D. - 3.15" SlimPRO	1/8"	.35"	.60"	3.15"	.78"	M6 x 1.0P	16081C-20
31538	CAT40 x 3/16" I.D. - 3.15" SlimPRO	3/16"	.43"	.68"	3.15"	.78"	M6 x 1.0P	16081C-20
31548	CAT40 x 1/4" I.D. - 3.15" SlimPRO	1/4"	.47"	.72"	3.15"	1.42"	M5 x 0.8P	16080C-20
31568	CAT40 x 3/8" I.D. - 3.15" SlimPRO	3/8"	.63"	.88"	3.15"	1.93"	M8 x 1.25P	16082C-20
31588	CAT40 x 1/2" I.D. - 3.15" SlimPro	1/2"	.70"	.96"	3.15"	1.93"	M10 x 1.5P	16083C-20
29103	CAT40 x 3mm I.D. - 80mm SlimPRO	3mm	9mm	15.5mm	80mm	45mm	M6 x 1.0P	16081C-20
29104	CAT40 x 4mm I.D. - 80mm SlimPRO	4mm	10mm	16.3mm	80mm	45mm	M6 x 1.0P	16081C-20
29106	CAT40 x 6mm I.D. - 80mm SlimPRO	6mm	12mm	18.3mm	80mm	45mm	M5 x 0.8P	16080C-20



# CAT40 SHRINKFIT HOLDERS



## FEATURES

- Balanced 25,000 RPM at G2.5
- 3 angled CoolBLAST ports direct coolant onto tool
- Maximum T.I.R. only 0.0001"

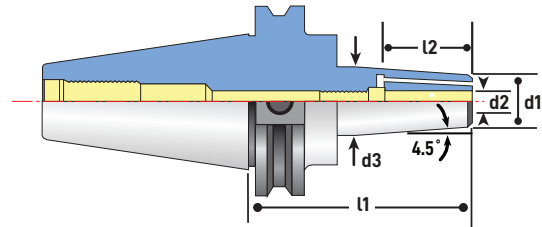

Techniks Certified ShrinkFIT holders are individually measured, tested and verified to meet or exceed our published specifications.

## CAT40 SHRINKFIT HOLDERS COOLBLAST

Part No.	Description	d1	d2	d3	l1	l2	stop screw thread	coolant stop screw
29004B	CAT40 x 1/8" I.D. - 5" with CoolBLAST	1/8"	.63"	.87"	5"	.79"	M8 x 1.25P	16081C-20
29008B	CAT40 x 3/16" I.D. - 5" with CoolBLAST	3/16"	.63"	.87"	5"	.79"	M6 x 1.0P	16081C-20
29014B	CAT40 x 1/4" I.D. - 6" with CoolBLAST	1/4"	.71"	1.40"	6"	1.42"	M5 x 0.8P	16080C-20
29018B	CAT40 x 5/16" I.D. - 5" with CoolBLAST	5/16"	.78"	1.06"	5"	1.42"	M6 x 1.0P	16081C-20
29023B	CAT40 x 3/8" I.D. - 5" with CoolBLAST	3/8"	.94"	1.26"	5"	1.53"	M8 x 1.25P	16082C-20
29029B	CAT40 x 1/2" I.D. - 5" with CoolBLAST	1/2"	1.10"	1.34"	5"	1.85"	M10 x 1.5P	16083C-20
29033B	CAT40 x 5/8" I.D. - 5" with CoolBLAST	5/8"	1.06"	1.34"	5"	1.97"	M12 x 1.75P	16085C-20
29036B	CAT40 x 3/4" I.D. - 4" with CoolBLAST	3/4"	1.42"	1.65"	4"	2.04"	M16 x 2.0P	16089C-20
29037B	CAT40 x 3/4" I.D. - 5" with CoolBLAST	3/4"	1.42"	1.65"	5"	2.04"	M16 x 2.0P	16089C-20

## COOLFLEX FEATURE

CoolFLEX holders are factory set for coolant-thru spindle. Remove the CoolFLEX screws for DIN B coolant-thru flange.

Part No.	Description
HSA-4-6	40 taper DIN B screw

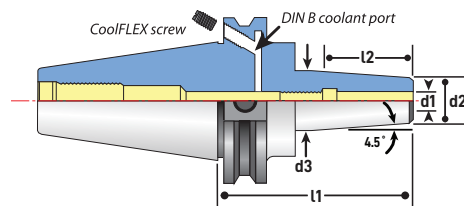
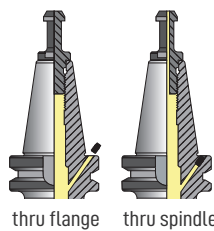

## CAT40 SHRINKFIT HOLDERS COOLFLEX

Part No.	Description	d1	d2	d3	l1	l2	stop screw thread	coolant stop screw
29011F	CAT40 x 1/4" I.D. - 3.5" with CoolFLEX	1/4"	.71"	1.06"	3.5"	1.42"	M5 x 0.8P	16080C-20
29021F	CAT40 x 3/8" I.D. - 3.75" with CoolFLEX	3/8"	.94"	1.26"	3.75"	1.53"	M8 x 1.25P	16082C-20
29027F	CAT40 x 1/2" I.D. - 3.75" with CoolFLEX	1/2"	1.10"	1.34"	3.75"	1.85"	M10 x 1.5P	16083C-20
29040F	CAT40 x 1" I.D. - 3" with CoolFLEX	1"	1.81"	2.04"	3"	2.28"	M20 x 2.0P	16091C-20
29042F	CAT40 x 1" I.D. - 4" with CoolFLEX	1"	1.81"	2.09"	4"	2.28"	M20 x 2.0P	16091C-20
29046F	CAT40 x 1-1/4" I.D. - 4" with CoolFLEX	1-1/4"	1.81"	2.09"	4"	2.28"	M20 x 2.0P	16091C-20



pg. 119



pg. 115



pg. 229



pg. 236

# CAT40 SHRINKFIT HOLDERS



Techniks Certified ShrinkFIT holders are individually measured, tested and verified to meet or exceed our published specifications.

## FEATURES

- Balanced 25,000 RPM at G2.5
- 3 angled CoolBLAST ports direct coolant onto tool
- CoolFLEX: through spindle and DIN-B coolant enabled

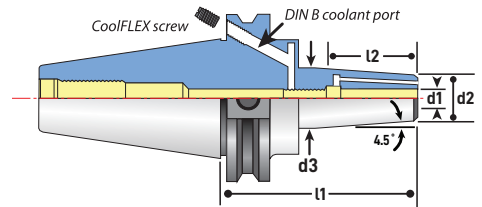

## CAT40 SHRINKFIT HOLDERS COOLBLAST AND COOLFLEX

Part No.	Description	d1	d2	d3	l1	l2	stop screw thread	coolant stop screw
29002FB	CAT40 x 1/8" I.D. - 3.5"	1/8"	.63"	.87"	3.5"	-	M6 x 1.0P	16081C-20
29006FB	CAT40 x 3/16" I.D. - 3.5"	3/16"	.63"	.87"	3.5"	-	M8 x 1.25P	16081C-20
29011FB	CAT40 x 1/4" I.D. - 3.5"	1/4"	.71"	1.06"	3.5"	1.42"	M5 x 0.8P	16080C-20
29016FB	CAT40 x 5/16" I.D. - 3.5"	5/16"	.78"	1.06"	3.5"	1.42"	M6 x 1.0P	16081C-20
29021FB	CAT40 x 3/8" I.D. - 3.75"	3/8"	.94"	1.26"	3.75"	1.53"	M8 x 1.25P	16082C-20
29023FB	CAT40 x 3/8" I.D. - 5"	3/8"	.94"	1.26"	5"	1.53"	M8 x 1.25P	16082C-20
29027FB	CAT40 x 1/2" I.D. - 3.75"	1/2"	1.10"	1.34"	3.75"	1.85"	M10 x 1.5P	16083C-20
29032FB	CAT40 x 5/8" I.D. - 3.75"	5/8"	1.06"	1.34"	3.75"	1.97"	M12 x 1.75P	16085C-20
29036FB	CAT40 x 3/4" I.D. - 4"	3/4"	1.42"	1.65"	4"	2.04"	M16 x 2.0P	16089C-20
29042FB	CAT40 x 1" I.D. - 4"	1"	1.81"	2.09"	4"	2.28"	M20 x 2.0P	16091C-20



**SHRINK LOCKED™**  
WITH FORMULA TTG 594

### Why Try ShrinkLOCKED?

- Run harder – higher speeds and feeds.
- Never spin or pull out a cutting tool.
- No modification to your tool shank required.
- No impact to accuracy or tool changes.
- Locked drive on standard carbide round shanks.

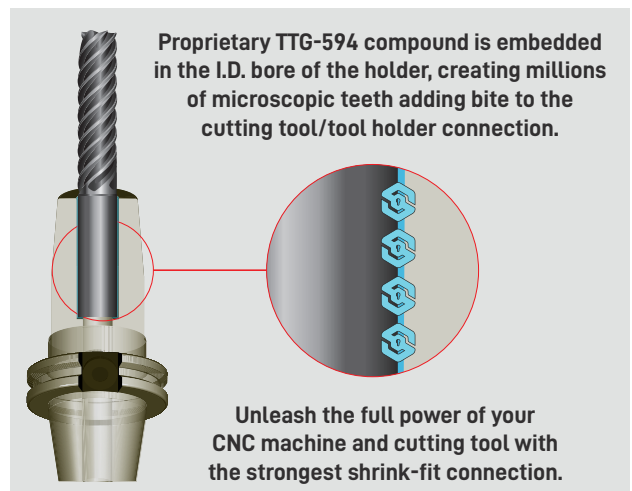

# CAT40 SHRINKFIT HOLDERS



## FEATURES

- Balanced 25,000 RPM at G2.5
- Maximum T.I.R. only 0.0001"
- CoolFLEX: through spindle and DIN-B coolant enabled

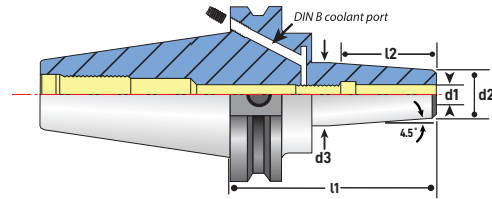

## CAT40 SHRINKFIT HOLDERS **DUALDRIVE WITH COOLFLEX**

Part No.	Description	d1	d2	d3	l1	l1	stop screw thread	coolant stop screw
46.651.54.350	SCAT40 x 1/4" I.D. - 3.5" DualDRIVE	1/4"	18mm	27mm	3.5"	36mm	M5 x 0.8P	16080C-20
46.651.56.375	SCAT40 x 3/8" I.D. - 3.75" DualDRIVE	3/8"	24mm	32mm	3.75"	42mm	M8 x 1.25P	16082C-20
46.651.58.375	SCAT40 x 1/2" I.D. - 3.75" DualDRIVE	1/2"	28mm	34mm	3.75"	47mm	M10 x 1.5P	16083C-20
46.651.64.400	SCAT40 x 3/4" I.D. - 4" DualDRIVE	3/4"	36mm	42mm	4"	52mm	M16 x 2.0P	16089C-20
46.651.68.400	SCAT40 x 1" I.D. - 4" DualDRIVE	1"	46mm	53mm	4"	58mm	M20 x 2.0P	16091C-20
46.651.72.400	SCAT40 x 1-1/4" I.D. - 4" DualDRIVE	1-1/4"	46mm	53mm	4"	58mm	M20 x 2.0P	16091C-20
46.651.03.400	SCAT40 x 3mm I.D. - 4" DualDRIVE	3mm	9mm	17mm	4"	18mm	M6 x 1.0P	16081C-20
46.651.03.600	SCAT40 x 3mm I.D. - 6" DualDRIVE	3mm	9mm	17mm	6"	18mm	M6 x 1.0P	16081C-20
46.651.04.300	SCAT40 x 4mm I.D. - 3" DualDRIVE	4mm	10mm	18mm	3"	20mm	M6 x 1.0P	16081C-20
46.651.06.300	SCAT40 x 6mm I.D. - 3" DualDRIVE	6mm	21mm	27mm	3"	36mm	M5 x 0.8P	16080C-20
46.651.06.600	SCAT40 x 6mm I.D. - 6" DualDRIVE	6mm	21mm	27mm	6"	36mm	M5 x 0.8P	16080C-20
46.651.08.300	SCAT40 x 8mm I.D. - 3" DualDRIVE	8mm	21mm	27mm	3"	36mm	M6 x 1.0P	16081C-20
46.651.10.300	SCAT40 x 10mm I.D. - 3" DualDRIVE	10mm	24mm	32mm	3"	42mm	M8 x 1.25P	16082C-20



**SHRINK LOCKED™**  
WITH FORMULA TTG 594

### Why Try ShrinkLOCKED?

- Run harder – higher speeds and feeds.
- Never spin or pull out a cutting tool.
- No modification to your tool shank required.
- No impact to accuracy or tool changes.
- Locked drive on standard carbide round shanks.

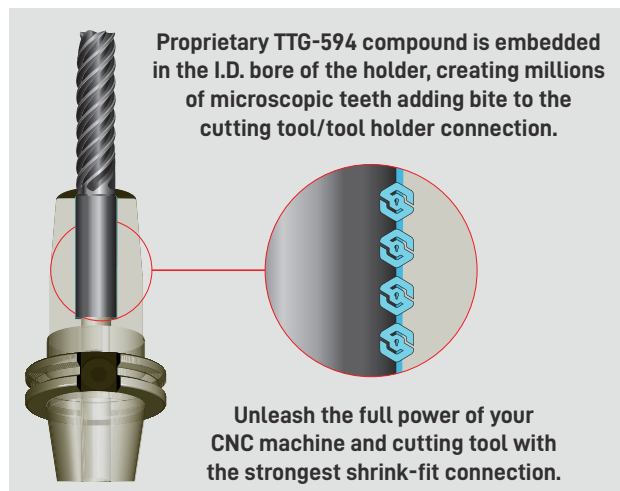



pg. 119



pg. 115



pg. 229



pg. 236

# CAT40 SHRINKFIT HOLDERS



Techniks Certified ShrinkFIT holders are individually measured, tested and verified to meet or exceed our published specifications.

## FEATURES

- Balanced 25,000 RPM at G2.5
- 3 angled CoolBLAST ports direct coolant onto tool
- CoolFLEX: through spindle and DIN-B coolant enabled

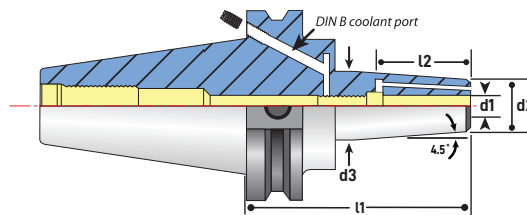

## CAT40 SHRINKFIT HOLDERS DUALDRIVE WITH COOLFLEX & COOLBLAST

Part No.	Description	d1	d2	d3	l1	l2	stop screw thread	coolant stop screw
46.651.52.400B	SCAT40 x 1/8" I.D. - 4" DualDRIVE w/BLAST	1/8"	.63"	.87"	4"	.79"	M6 x 1.0P	16081C-20
46.651.53.400B	SCAT40 x 3/16" I.D. - 4" DualDRIVE w/BLAST	3/16"	.63"	.87"	4"	.79"	M6 x 1.0P	16081C-20
46.651.53.600B	SCAT40 x 3/16" I.D. - 6" DualDRIVE w/BLAST	3/16"	.63"	.87"	6"	.79"	M6 x 1.0P	16081C-20
46.651.54.400B	SCAT40 x 1/4" I.D. - 4" DualDRIVE w/BLAST	1/4"	.71"	.94"	4"	1.42"	M5 x 0.8P	16080C-20
46.651.54.600B	SCAT40 x 1/4" I.D. - 6" DualDRIVE w/BLAST	1/4"	.71"	.94"	6"	1.42"	M5 x 0.8P	16080C-20
46.651.55.300B	SCAT40 x 5/16" I.D. - 3" DualDRIVE w/BLAST	5/16"	.79"	1.06"	3"	1.42"	M6 x 1.0P	16081C-20
46.651.55.375B	SCAT40 x 5/16" I.D. - 3.75" DualDRIVE w/BLAST	5/16"	.79"	1.06"	3.75"	1.42"	M6 x 1.0P	16081C-20
46.651.56.375B-2.5	SCAT40 x 3/8" I.D. - 3.75" DualDRIVE w/BLAST	3/8"	.94"	1.18"	3.75"	2.52"	M8 x 1.25P	16082C-20
46.651.56.400B	SCAT40 x 3/8" I.D. - 4" DualDRIVE w/BLAST	3/8"	.94"	1.18"	4"	1.65"	M8 x 1.25P	16082C-20
46.651.57.300B	SCAT40 x 7/16" I.D. - 3" DualDRIVE w/BLAST	7/16"	.94"	1.18"	3"	1.62"	M10 x 1.5P	16083C-20
46.651.58.315B	SCAT40 x 1/2" I.D. - 3.15" DualDRIVE w/BLAST	1/2"	1.10"	1.34"	3.15"	1.85"	M10 x 1.5P	16083C-20
46.651.58.375B	SCAT40 x 1/2" I.D. - 3.75" DualDRIVE w/BLAST	1/2"	1.10"	1.34"	3.75"	1.85"	M10 x 1.5P	16083C-20
46.651.59.300B	SCAT40 x 9/16" I.D. - 3" DualDRIVE w/BLAST	9/16"	1.10"	1.34"	3"	1.85"	M10 x 1.5P	16083C-20
46.651.61.300B	SCAT40 x 5/8" I.D. - 3" DualDRIVE w/BLAST	5/8"	1.06"	1.34"	3"	1.97"	M12 x 1.75P	16085C-20
46.651.64.400B	SCAT40 x 3/4" I.D. - 4" DualDRIVE w/BLAST	3/4"	1.26"	1.37"	4"	2.04"	M16 x 2.0P	16089C-20
46.651.64.600B	SCAT40 x 3/4" I.D. - 6" DualDRIVE w/BLAST	3/4"	1.26"	1.37"	6"	2.04"	M16 x 2.0P	16089C-20



### 3-PORT COOLANT-THRU DESIGN

Three coolant ports for increased volume & easier tool removal.

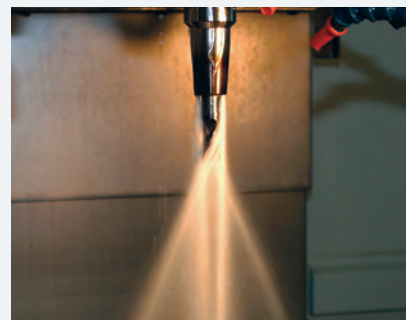

CoolBLAST coolant ports direct coolant on the tool path, even at high RPMs.





# CAT50 SHRINKFIT HOLDERS



## FEATURES

- Maximum T.I.R. only 0.0001"
- Balanced 25,000 RPM at G2.5
- Coolant-thru stop screw included



Techniks Certified ShrinkFIT holders are individually measured, tested and verified to meet or exceed our published specifications.

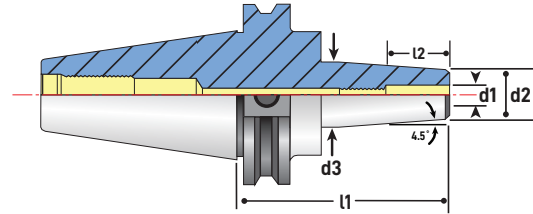

## CAT50 SHRINKFIT HOLDERS INCH

Part No.	Description	d1	d2	d3	l1	l2	stop screw thread	coolant stop screw
29051	CAT50 x 1/8" I.D. - 4"	1/8"	.36"	.72"	4"	.79"	M6 x 1.0P	16081C-20
29052	CAT50 x 3/16" I.D. - 3.54"	3/16"	.42"	.74"	3.54"	.79"	M6 x 1.0P	16081C-20
29052-6	CAT50 x 3/16" I.D. - 6"	3/16"	.42"	.71"	6"	.79"	M6 x 1.0P	16081C-20
29054	CAT50 x 1/4" I.D. - 3.54"	1/4"	.71"	1.02"	3.54"	1.42"	M5 x 0.8P	16080C-20
29054-6	CAT50 x 1/4" I.D. - 6"	1/4"	.71"	1.06"	6"	1.42"	M8 x 1.25P	16080C-20
29054-8	CAT50 x 1/4" I.D. - 8"	1/4"	.71"	1.06"	8"	1.42"	M5 x 0.8P	16080C-20
29056	CAT50 x 5/16" I.D. - 3.54"	5/16"	.79"	1.06"	3.54"	1.42"	M6 x 1.0P	16081C-20
29058	CAT50 x 3/8" I.D. - 3.94"	3/8"	.94"	1.26"	3.94"	1.42"	M8 x 1.25P	16082C-20
29058-6	CAT50 x 3/8" I.D. - 6"	3/8"	.78"	1.06"	6"	1.42"	M8 x 1.25P	16082C-20
29058-8	CAT50 x 3/8" I.D. - 8"	3/8"	.78"	1.06"	8"	1.42"	M8 x 1.25P	16082C-20
29060	CAT50 x 1/2" I.D. - 3.94"	1/2"	1.10"	1.34"	3.94"	1.85"	M10 x 1.5P	16083C-20
29060-6	CAT50 x 1/2" I.D. - 6"	1/2"	1.10"	1.34"	6"	1.85"	M10 x 1.5P	16081C-20
29060-8	CAT50 x 1/2" I.D. - 8"	1/2"	1.10"	1.34"	8"	1.85"	M10 x 1.5P	16083C-20
29062	CAT50 x 5/8" I.D. - 3.94"	5/8"	1.06"	1.34"	3.94"	1.97"	M12 x 1.75P	16085C-20
29062-6	CAT50 x 5/8" I.D. - 6"	5/8"	1.06"	1.34"	6"	1.97"	M12 x 1.75P	16085C-20
29064	CAT50 x 3/4" I.D. - 4.13"	3/4"	1.42"	1.65"	4.13"	2.04"	M16 x 2.0P	16089C-20
29066	CAT50 x 3/4" I.D. - 6"	3/4"	1.42"	1.65"	6"	2.04"	M16 x 2.0P	16089C-20
29068	CAT50 x 1" I.D. - 4.13"	1"	1.81"	2.09"	4.13"	2.28"	M20 x 2.0P	16091C-20
29070	CAT50 x 1" I.D. - 6"	1"	1.81"	2.09"	6"	2.28"	M20 x 2.0P	16091C-20
29072	CAT50 x 1-1/4" I.D. - 4.13"	1-1/4"	1.81"	2.09"	4.13"	2.28"	M20 x 2.0P	16091C-20
29074	CAT50 x 1-1/4" I.D. - 4.72"	1-1/4"	1.81"	2.09"	4.72"	2.28"	M20 x 2.0P	16091C-20
29076	CAT50 x 1-1/4" I.D. - 6"	1-1/4"	1.81"	2.09"	6"	2.28"	M20 x 2.0P	16091C-20



pg. 119



pg. 115



pg. 229



pg. 236

# CAT50 SHRINKFIT HOLDERS



Techniks Certified ShrinkFIT holders are individually measured, tested and verified to meet or exceed our published specifications.

## FEATURES

- Maximum T.I.R. only 0.0001"
- Balanced 25,000 RPM at G2.5
- Coolant-thru stop screw included

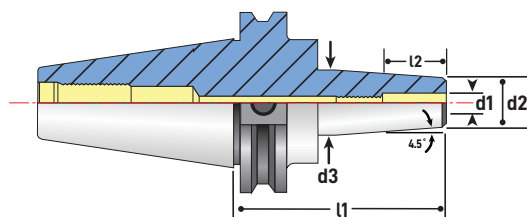

## CAT50 SHRINKFIT HOLDERS METRIC

Part No.	Description	d1	d2	d3	l1	l2	stop screw thread	coolant stop screw
29252	CAT50 x 6mm I.D. - 100mm	6mm	21mm	27mm	100mm	36mm	M5 x 0.8P	16080C-20
29254	CAT50 x 6mm I.D. - 150mm	6mm	21mm	27mm	150mm	36mm	M5 x 0.8P	16080C-20
29254-8	CAT50 x 6mm I.D. - 203mm	6mm	21mm	27mm	203mm	36mm	M5 x 0.8P	16080C-20
29256	CAT50 x 8mm I.D. - 100mm	8mm	21mm	27mm	100mm	36mm	M6 x 1.0P	16081C-20
29258	CAT50 x 8mm I.D. - 150mm	8mm	21mm	27mm	150mm	36mm	M6 x 1.0P	16081C-20
29258-8	CAT50 x 8mm I.D. - 203mm	8mm	21mm	27mm	203mm	36mm	M6 x 1.0P	16081C-20
29260	CAT50 x 10mm I.D. - 100mm	10mm	24mm	32mm	100mm	42mm	M8 x 1.25P	16082C-20
29262	CAT50 x 10mm I.D. - 150mm	10mm	24mm	32mm	150mm	42mm	M8 x 1.25P	16082C-20
29264	CAT50 x 12mm I.D. - 100mm	12mm	24mm	32mm	100mm	47mm	M10 x 1.5P	16083C-20
29266	CAT50 x 12mm I.D. - 150mm	12mm	24mm	32mm	150mm	47mm	M10 x 1.5P	16083C-20
29266-8	CAT50 x 12mm I.D. - 203mm	12mm	24mm	32mm	203mm	47mm	M10 x 1.5P	16083C-20
29268	CAT50 x 14mm I.D. - 100mm	14mm	27mm	34mm	100mm	47mm	M10 x 1.5P	16083C-20
29270	CAT50 x 14mm I.D. - 150mm	14mm	27mm	34mm	150mm	47mm	M10 x 1.5P	16083C-20
29272	CAT50 x 16mm I.D. - 100mm	16mm	27mm	34mm	100mm	50mm	M12 x 1.75P	16085C-20
29274	CAT50 x 16mm I.D. - 160mm	16mm	27mm	34mm	160mm	50mm	M12 x 1.75P	16085C-20
29276	CAT50 x 18mm I.D. - 100mm	18mm	33mm	42mm	100mm	50mm	M12 x 1.75P	16085C-20
29278-100	CAT50 x 20mm I.D. - 100mm	20mm	33mm	42mm	100mm	52mm	M16 x 2.0P	16089C-20
29278-160	CAT50 x 20mm I.D. - 160mm	20mm	33mm	42mm	160mm	52mm	M16 x 2.0P	16089C-20
29280	CAT50 x 25mm I.D. - 100mm	25mm	44mm	53mm	100mm	58mm	M20 x 2.0P	16091C-20
29280-160	CAT50 x 25mm I.D. - 160mm	25mm	44mm	53mm	160mm	52mm	M20 x 2.0P	16091C-20
29282	CAT50 x 32mm I.D. - 100mm	32mm	44mm	53mm	100mm	58mm	M20 x 2.0P	16091C-20

# CAT50 SHRINKFIT HOLDERS



## FEATURES

- Balanced 25,000 RPM at G2.5
- 3 angled CoolBLAST ports direct coolant onto tool
- Maximum T.I.R. only 0.0001"

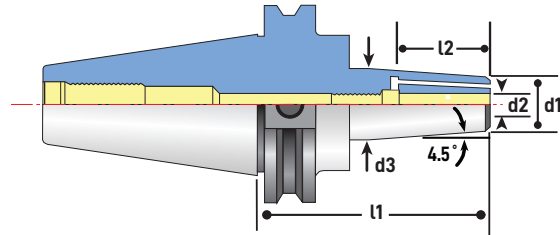

Techniks Certified ShrinkFIT holders are individually measured, tested and verified to meet or exceed our published specifications.

## CAT50 SHRINKFIT HOLDERS **COOLBLAST**

Part No.	Description	d1	d2	d3	l1	l2	stop screw thread	coolant stop screw
29054B	CAT50 x 1/4" I.D. - 3.54" with CoolBLAST	1/4"	0.71"	0.98"	3.54"	1.42"	M5 x 0.8P	16080C-20
29054-6B	CAT50 x 1/4" I.D. - 6" with CoolBLAST	1/4"	0.71"	1.06"	6"	1.42"	M5 x 0.8P	16080C-20
29054-8B	CAT50 x 1/4" I.D. - 8" with CoolBLAST	1/4"	.71"	1.02"	8"	1.42"	M5 x 0.8P	16080C-20
29058B	CAT50 x 3/8" I.D. - 3.94" with CoolBLAST	3/8"	0.94"	1.26"	3.94"	1.42"	M8 x 1.25P	16082C-20
29058-6B	CAT50 x 3/8" I.D. - 6" with CoolBLAST	3/8"	0.94"	1.26"	6"	1.65"	M8 x 1.25P	16082C-20
29060B	CAT50 x 1/2" I.D. - 3.94" with CoolBLAST	1/2"	1.10"	1.34"	3.94"	1.85"	M10 x 1.5P	16083C-20
29060-6B	CAT50 x 1/2" I.D. - 6" with CoolBLAST	1/2"	1.10"	1.34"	6"	1.85"	M10 x 1.5P	16083C-20
29062B	CAT50 x 5/8" I.D. - 3.94" with CoolBLAST	5/8"	1.06"	1.34"	3.94"	1.97"	M12 x 1.75P	16085C-20
29062-6B	CAT50 x 5/8" I.D. - 6" with CoolBLAST	5/8"	1.06"	1.34"	6"	1.97"	M12 x 1.75P	16085C-20
29064B	CAT50 x 3/4" I.D. - 4.13" with CoolBLAST	3/4"	1.42"	1.65"	4.13"	2.04"	M16 x 2.0P	16089C-20
29066B	CAT50 x 3/4" I.D. - 6" with CoolBLAST	3/4"	1.42"	1.65"	6"	2.04"	M16 x 2.0P	16089C-20
29066-8B	CAT 50 x 3/4" I.D - 8" with CoolBLAST	3/4"	1.42"	1.65"	8"	2.04"	M16 x 2.0P	16089C-20
29068B	CAT50 x 1" I.D. - 4.13" with CoolBLAST	1"	1.81"	2.09"	4.13"	2.28"	M20 x 2.0P	16091C-20
29070B	CAT50 x 1" I.D. - 6" with CoolBLAST	1"	1.81"	2.09"	6"	2.28"	M20 x 2.0P	16091C-20
29072B	CAT50 x 1-1/4" I.D. - 4.13" with CoolBLAST	1-1/4"	1.81"	2.09"	4.13"	2.28"	M20 x 2.0P	16091C-20
29252B	CAT50 x 6mm I.D - 100mm with CoolBLAST	6mm	0.83"	1.06"	100mm	1.42"	M5 x 0.8P	16080C-20
29260B	CAT50 x 10mm I.D - 100mm with CoolBLAST	10mm	0.94"	1.26"	100mm	1.42"	M8 x 1.25P	16082C-20



pg. 119



pg. 115



pg. 229



pg. 236

# CAT50 SHRINKFIT HOLDERS

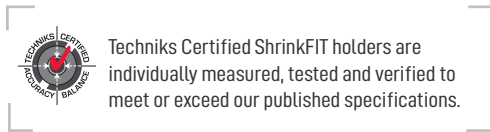

Techniks Certified ShrinkFIT holders are individually measured, tested and verified to meet or exceed our published specifications.

## FEATURES

- Balanced 25,000 RPM at G2.5
- DualDRIVE for dual-contact spindles increases rigidity and accuracy
- CoolFLEX: through spindle and DIN-B coolant enabled

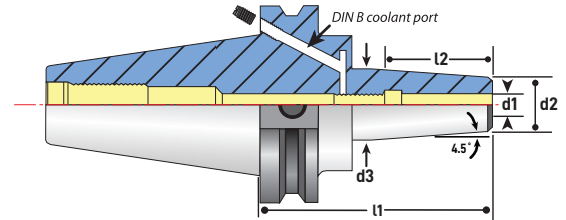

## CAT50 SHRINKFIT HOLDERS DUALDRIVE WITH COOLFLEX

Part No.	Description	d1	d2	d3	l1	l2	stop screw thread	coolant stop screw
47.651.54.354	SCAT50 x 1/4" I.D. - 3.54" DualDRIVE	1/4"	.71"	1.02"	3.54"	1.42"	M5 x 0.8P	16080C-20
47.651.56.394	SCAT50 x 3/8" I.D. - 3.94" DualDRIVE	3/8"	.94"	1.26"	3.94"	1.42"	M8 x 1.25P	16082C-20
47.651.58.394	SCAT50 x 1/2" I.D. - 3.94" DualDRIVE	1/2"	1.10"	1.34"	3.94"	1.85"	M10 x 1.5P	16083C-20
47.651.61.394	SCAT50 x 5/8" I.D. - 3.94" DualDRIVE	5/8"	1.06"	1.34"	3.94"	1.97"	M12 x 1.75P	16085C-20
47.651.64.413	SCAT50 x 3/4" I.D. - 4.13" DualDRIVE	3/4"	1.42"	1.65"	4.13"	2.04"	M16 x 2.0P	16089C-20
47.651.68.413	SCAT50 x 1" I.D. - 4.13" DualDRIVE	1"	1.81"	2.09"	4.13"	2.28"	M20 x 2.0P	16091C-20
47.651.72.413	SCAT50 x 1-1/4" I.D. - 4.13" DualDRIVE	1-1/4"	1.81"	2.09"	4.13"	2.28"	M20 x 2.0P	16091C-20
47.651.58.600	SCAT50 x 1/2" I.D. - 6" DualDRIVE	1/2"	1.10"	1.34"	6"	1.85"	M10 x 1.5P	16081C-20
47.651.25.100	SCAT50 x 25mm I.D. - 100mm DualDRIVE	25mm	44mm	53mm	100mm	58mm	M20 x 2.0P	16091C-20
47.651.32.100	SCAT50 x 32mm I.D. - 100mm DualDRIVE	32mm	44mm	53mm	100mm	58mm	M20 x 2.0P	16091C-20

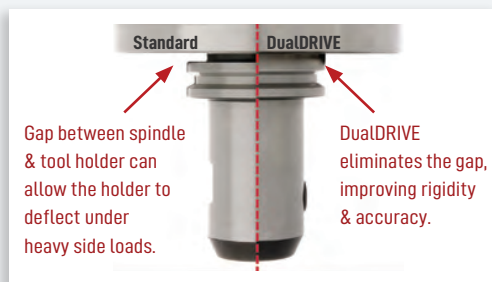

## DUAL-CONTACT SPINDLES

Dual-Contact is a spindle option offered by some machine tool builders where both the toolholder taper and the flange make contact with the spindle. The dual-contact increases rigidity and accuracy during heavy side loads.



# BT30 SHRINKFIT HOLDERS



Techniks Certified ShrinkFIT holders are individually measured, tested and verified to meet or exceed our published specifications.

## FEATURES

- Maximum T.I.R. only 0.0001"
- Balanced 25,000 RPM at G2.5
- Coolant-thru stop screw included

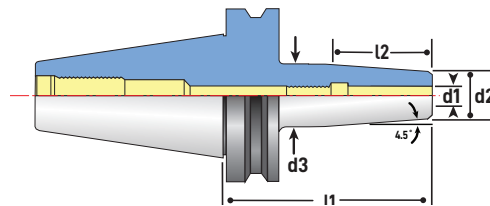

## BT30 SHRINKFIT HOLDERS

Part No.	Description	d1	d2	d3	l1	l2	stop screw thread	coolant stop screw
67250	BT30 x 1/4" I.D. - 3"	1/4"	0.83"	1.06"	3"	1.42"	M5 x 0.8P	16082C-20
67375	BT30 x 3/8" I.D. - 3"	3/8"	0.94"	1.26"	3"	1.42"	M8 x 1.25P	16082C-20
67500	BT30 x 1/2" I.D. - 3"	1/2"	0.94"	1.26"	3"	1.85"	M10 x 1.5P	16083C-20
67625	BT30 x 5/8" I.D. - 3"	5/8"	1.06"	1.34"	3"	1.97"	M12 x 1.75P	16085C-20
67750	BT30 x 3/4" I.D. - 3"	3/4"	1.30"	1.62"	3"	2.04"	M16 x 2.0P	16089C-20



## FEATURES

- Balanced 25,000 RPM at G2.5
- DualDRIVE for dual-contact spindles increases rigidity and accuracy
- Improved performance at high metal removal rates or when machining at extended lengths

## BT30 SHRINKFIT HOLDERS DUALDRIVE

Part No.	Description	d1	d2	d3	l1	l2	stop screw thread	coolant stop screw
25.651.54.300	SBT30 x 1/4" I.D. - 3" DualDRIVE	1/4"	.83"	1.06"	3"	1.42"	M8 x 1.25P	16082C-20
25.651.56.300	SBT30 x 3/8" I.D. - 3" DualDRIVE	3/8"	.94"	1.26"	3"	1.42"	M8 x 1.25P	16082C-20
25.651.58.300	SBT30 x 1/2" I.D. - 3" DualDRIVE	1/2"	.94"	1.26"	3"	1.85"	M10 x 1.5P	16083C-20
25.651.61.300	SBT30 x 5/8" I.D. - 3" DualDRIVE	5/8"	1.06"	1.34"	3"	1.97"	M12 x 1.75P	16085C-20
25.651.64.300	SBT30 x 3/4" I.D. - 3" DualDRIVE	3/4"	1.30"	1.62"	3"	2.04"	M16 x 2.0P	16089C-20

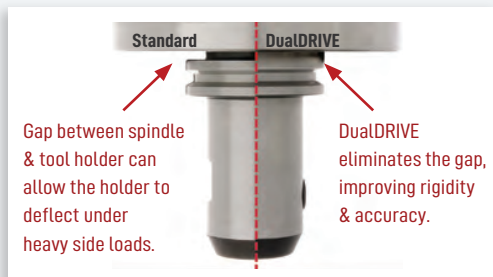

## DUAL-CONTACT SPINDLES

Dual-Contact is a spindle option offered by some machine tool builders where both the toolholder taper and the flange make contact with the spindle. The dual-contact increases rigidity and accuracy during heavy side loads.



pg. 119



pg. 115



pg. 229



pg. 236

# BT40 SHRINKFIT HOLDERS



Techniks Certified ShrinkFIT holders are individually measured, tested and verified to meet or exceed our published specifications.

## FEATURES

- Maximum T.I.R. only 0.0001"
- Balanced 25,000 RPM at G2.5
- Coolant-thru stop screw included

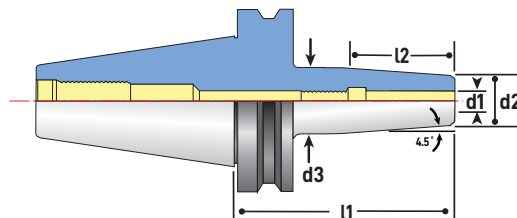

## BT40 SHRINKFIT HOLDERS

Part No.	Description	d1	d2	d3	l1	l2	stop screw thread	coolant stop screw
19019-6	BT40 x 1/8" I.D. - 6"	1/8"	.36"	.63"	6"	0.70"	M6 x 1.0P	16081C-20
39110	BT40 x 3/16" I.D. - 3.54	3/16"	.43"	.75"	6"	.79"	M6 x 1.0P	16081C-20
19020-6	BT40 x 3/16" I.D. - 6"	3/16"	.43"	.70"	6"	0.79"	M6 x 1.0P	16081C-20
39111	BT40 x 1/4" I.D. - 3.54	1/4"	.82"	1.06"	6"	1.42"	M5 x 0.8P	16080C-20
19022-6	BT40 x 1/4" I.D. - 6"	1/4"	.49"	.83"	6"	1.42"	M5 x 0.8P	16080C-20
39113	BT40 x 3/8" I.D. - 3.54	3/8"	.94"	1.25"	6"	1.65"	M8 x 1.25P	16082C-20
19026-6	BT40 x 3/8" I.D. - 6"	3/8"	.61"	.94"	6"	1.65"	M8 x 1.25P	16082C-20
39114	BT40 x 1/2" I.D. - 3.54	1/2"	1.10"	1.34"	6"	1.85"	M10 x 1.5P	16083C-20
19028-6	BT40 x 1/2" I.D. - 6"	1/2"	.74"	1.06"	6"	1.85"	M10 x 1.5P	16083C-20
19029	BT40 x 5/8" I.D. - 3.54	5/8"	1.06"	1.34"	6"	1.96"	M12 x 1.75P	16089C-20
19030-6	BT40 x 5/8" I.D. - 6"	5/8"	1.06"	1.34"	6"	1.96"	M12 x 1.75P	16085C-20
39115	BT40 x 3/4" I.D. - 3.54	3/4"	1.29"	1.65"	6"	2.04"	M16 x 2.0P	16085C-20
19032-6	BT40 x 3/4" I.D. - 6"	3/4"	1.29"	1.65"	6"	1.65"	M16 x 2.0P	16089C-20
39117	BT40 x 1" I.D. - 3.54	1"	1.73"	2.08"	6"	2.28"	M20 x 2.0P	16089C-20
19034-6	BT40 x 1" I.D. - 6"	1"	1.73"	2.09"	6"	2.28"	M20 x 2.0P	16091C-20
39119-4.13	BT40 x 1-1/4" I.D. - 4.13	1-1/4"	1.81"	2.08"	6"	2.28"	M20 x 2.0P	16091C-20
19136-135	BT40 x 6mm I.D. - 135mm	6mm	12mm	26mm	135mm	36mm	M5 x 0.8P	16080C-20
19138	BT40 x 8mm I.D. - 90mm	8mm	21mm	26mm	90mm	36mm	M6 x 1.0P	16081C-20
19138-135	BT40 x 8mm I.D. - 135mm	8mm	14mm	36mm	135mm	36mm	M6 x 1.0P	16081C-20
19140	BT40 x 10mm I.D. - 90mm	10mm	24mm	29mm	90mm	36mm	M8 x 1.25P	16082C-20
19140-135	BT40 x 10mm I.D. - 135mm	10mm	16mm	36mm	135mm	42mm	M8 x 1.25P	16082C-20
19142	BT40 x 12mm I.D. - 90mm	12mm	24mm	29mm	90mm	47mm	M10 x 1.5P	16083C-20
19142-135	BT40 x 12mm I.D. - 135mm	12mm	15mm	29mm	135mm	47mm	M10 x 1.5P	16083C-20





# BT40 SHRINKFIT HOLDERS



pg. 119

pg. 115

pg. 229

pg. 236



Techniks Certified ShrinkFIT holders are individually measured, tested and verified to meet or exceed our published specifications.

## FEATURES

- Maximum T.I.R. only 0.0001"
- DualDRIVE for dual-contact spindles increases rigidity and accuracy
- CoolFLEX: through spindle and DIN-B coolant enabled

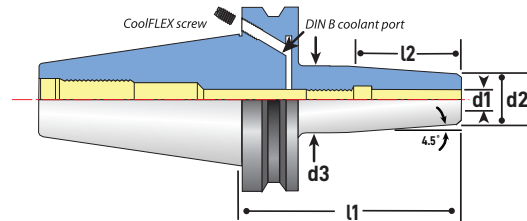

## BT40 SHRINKFIT HOLDERS DUALDRIVE

Part No.	Description	d1	d2	d3	l1	l2	stop screw thread	coolant stop screw
26.651.54.600	SBT40 x 1/4" I.D. - 6" DualDRIVE	1/4"	.71"	1.38"	6"	1.42"	M5 x 0.8P	16080C-20
26.651.56.600	SBT40 x 3/8" I.D. - 6" DualDRIVE	3/8"	0.94"	1.38"	6"	1.53"	M8 x 1.25P	16082C-20
26.651.58.600	SBT40 x 1/2" I.D. - 6" DualDRIVE	1/2"	1.1"	1.38"	6"	1.85"	M10 x 1.5P	16083C-20
26.651.61.354	SBT40 x 5/8" I.D. - 3.54" DualDRIVE	5/8"	1.06"	1.34"	3.54"	1.97"	M12 x 1.75P	16089C-20
26.651.61.600	SBT40 x 5/8" I.D. - 6" DualDRIVE	5/8"	1.06"	1.34"	6"	1.97"	M12 x 1.75P	16089C-20
26.651.64.600	SBT40 x 3/4" I.D. - 6" DualDRIVE	3/4"	1.42"	1.38"	6"	2.04"	M16 x 2.0P	16085C-20
26.651.06.135	SBT40 x 6mm I.D. - 135mm DualDRIVE	6mm	21mm	27mm	135mm	36mm	M5 x 0.8P	16080C-20
26.651.08.135	SBT40 x 8mm I.D. - 135mm DualDRIVE	8mm	24mm	32mm	135mm	42mm	M8 x 1.25P	16082C-20
26.651.12.090	SBT40 x 12mm I.D. - 90mm DualDRIVE	12mm	24mm	33mm	90mm	47mm	M10 x 1.5P	16083C-20
26.651.12.135	SBT40 x 12mm I.D. - 135mm DualDRIVE	12mm	24mm	33mm	135mm	47mm	M10 x 1.5P	16083C-20

## BT40 SHRINKFIT HOLDERS DUALDRIVE COOLFLEX

Part No.	Description	d1	d2	d3	l1	l2	stop screw thread	coolant stop screw
28.651.52.350	SBT40 x 1/8" I.D. - 3.5" DualDRIVE	1/8"	.36"	.63"	3.5"	.79"	M6 x 1.0P	16081C-20
28.651.53.350	SBT40 x 3/16" I.D. - 3.5" DualDRIVE	3/16"	.43"	.70"	3.5"	.79"	M6 x 1.0P	16081C-20
28.651.54.350	SBT40 x 1/4" I.D. - 3.5" DualDRIVE	1/4"	.71"	.94"	3.5"	1.42"	M5 x 0.8P	16080C-20
28.651.55.350	SBT40 x 5/16" I.D. - 3.5" DualDRIVE	5/16"	.79"	1.06"	3.5"	1.42"	M6 x 1.0P	16081C-20
28.651.56.350	SBT40 x 3/8" I.D. - 3.5" DualDRIVE	3/8"	.94"	1.26"	3.5"	1.65"	M8 x 1.25P	16082C-20
28.651.58.350	SBT40 x 1/2" I.D. - 3.5" DualDRIVE	1/2"	1.10"	1.34"	3.5"	1.85"	M10 x 1.5P	16083C-20
28.651.61.350	SBT40 x 5/8" I.D. - 3.5" DualDRIVE	5/8"	1.06"	1.34"	3.5"	1.97"	M12 x 1.75P	16089C-20
28.651.64.350	SBT40 x 3/4" I.D. - 3.5" DualDRIVE	3/4"	1.42"	1.65"	3.5"	2.04"	M16 x 2.0P	16085C-20
28.651.68.400	SBT40 x 1" I.D. - 4" DualDRIVE	1"	1.81"	2.04"	4"	2.08"	M20 x 2.0P	16089C-20
28.651.72.400	SBT40 x 1-1/4" I.D. - 4" DualDRIVE	1-1/4"	1.81"	2.09"	4"	2.28"	M20 x 2.0P	16089C-20
28.651.03.090	SBT40 x 3mm I.D. - 90mm DualDRIVE	3mm	9mm	17.7mm	90mm	18mm	M8 x 1.25P	16082C-20
28.651.04.090	SBT40 x 4mm I.D. - 90mm DualDRIVE	4mm	10mm	18.7mm	90mm	20mm	M8 x 1.25P	16082C-20
28.651.06.090	SBT40 x 6mm I.D. - 90mm DualDRIVE	6mm	21mm	27mm	90mm	36mm	M5 x 0.8P	16080C-20
28.651.08.090	SBT40 x 8mm I.D. - 90mm DualDRIVE	8mm	21mm	27mm	90mm	36mm	M6 x 1.0P	16081C-20
28.651.10.090	SBT40 x 10mm I.D. - 90mm DualDRIVE	10mm	24mm	32mm	90mm	42mm	M8 x 1.25P	16082C-20



pg. 119



pg. 115



pg. 229



pg. 236

# HSK63A SHRINKFIT HOLDERS



Techniks Certified ShrinkFIT holders are individually measured, tested and verified to meet or exceed our published specifications.

## FEATURES

- Maximum T.I.R. only 0.0001"
- Balanced 25,000 RPM at G2.5
- Coolant-thru stop screw included

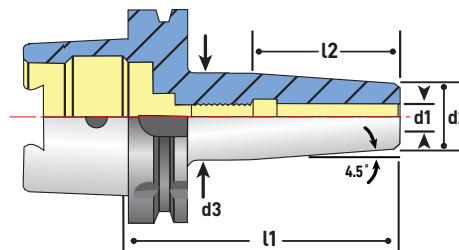

## HSK63A SHRINKFIT HOLDERS INCH

Part No.	Description	d1	d2	d3	l1	l2	stop screw thread	coolant stop screw	Coolant Pipe
93115	HSK63A x 1/4" I.D. - 3.15"	1/4"	.83"	1.06"	3.15"	1.42"	M5 x 0.8P	16080C-20	92004
93116	HSK63A x 5/16" I.D. - 3.15"	5/16"	.83"	1.06"	3.15"	1.42"	M6 x 1.0P	16081C-20	92004
93117	HSK63A x 3/8" I.D. - 3.35"	3/8"	.94"	1.26"	3.35"	1.65"	M8 x 1.25P	16082C-20	92004
93130	HSK63A x 3/8" I.D. - 6.3"	3/8"	.94"	1.26"	6.3"	1.65"	M8 x 1.25P	16082C-20	92004
93118	HSK63A x 7/16" I.D. - 3.54"	7/16"	.94"	1.26"	3.54"	1.85"	M8 x 1.25P	16082C-20	92004
93119	HSK63A x 1/2" I.D. - 3.54"	1/2"	.94"	1.26"	3.54"	1.85"	M10 x 1.5P	16083C-20	92004
93135	HSK63A x 1/2" I.D. - 6.3"	1/2"	.94"	1.10"	6.3"	1.85"	M10 x 1.5P	16083C-20	92004
93120	HSK63A x 9/16" I.D. - 3.54"	9/16"	1.06"	1.34"	3.54"	1.85"	M10 x 1.5P	16083C-20	92004
93121	HSK63A x 5/8" I.D. - 3.74"	5/8"	1.06"	1.34"	3.74"	1.97"	M12 x 1.75P	16085C-20	92004
93124	HSK63A x 3/4" I.D. - 3.94"	3/4"	1.30"	1.65"	3.94"	2.05"	M16 x 2.0P	16089C-20	92004
93140	HSK63A x 3/4" I.D. - 6.3"	3/4"	1.42"	1.65"	6.3"	2.05"	M16 x 2.0P	16089C-20	92004
93126	HSK63A x 1" I.D. - 4.53"	1"	1.73"	2.05"	4.53"	2.28"	M20 x 2.0P	16091C-20	92004
93145	HSK63A x 1" I.D. - 6.3"	1"	1.73"	2.09"	6.3"	2.28"	M20 x 2.0P	16091C-20	92004
93128	HSK63A x 1-1/4" I.D. - 4.72"	1-1/4"	1.73"	2.09"	4.72"	2.28"	M20 x 2.0P	16091C-20	92004

## HSK63A SHRINKFIT HOLDERS METRIC

Part No.	Description	d1	d2	d3	l1	l2	stop screw thread	coolant stop screw	Coolant Pipe
39132	HSK63A x 4mm I.D. - 80mm	4mm	10mm	22mm	80mm	20mm	M6 x 1.0P	16081C-20	92004
39134	HSK63A x 5mm I.D. - 80mm	5mm	16mm	22mm	80mm	20mm	M6 x 1.0P	16081C-20	92004
39136	HSK63A x 6mm I.D. - 80mm	6mm	21mm	27mm	80mm	36mm	M5 x 0.8P	16080C-20	92004
39138	HSK63A x 8mm I.D. - 80mm	8mm	21mm	27mm	80mm	36mm	M6 x 1.0P	16081C-20	92004
39140	HSK63A x 10mm I.D. - 85mm	10mm	24mm	32mm	85mm	42mm	M8 x 1.25P	16082C-20	92004
39142	HSK63A x 12mm I.D. - 90mm	12mm	24mm	32mm	90mm	47mm	M10 x 1.5P	16083C-20	92004
39144	HSK63A x 14mm I.D. - 90mm	14mm	27mm	34mm	90mm	47mm	M10 x 1.5P	16083C-20	92004
39146	HSK63A x 16mm I.D. - 95mm	16mm	27mm	34mm	95mm	50mm	M12 x 1.75P	16085C-20	92004
39148	HSK63A x 18mm I.D. - 95mm	18mm	33mm	42mm	95mm	50mm	M12 x 1.75P	16085C-20	92004
39150	HSK63A x 20mm I.D. - 100mm	20mm	33mm	42mm	100mm	52mm	M16 x 2.0P	16089C-20	92004
39152	HSK63A x 25mm I.D. - 115mm	25mm	44mm	53mm	115mm	58mm	M20 x 2.0P	16091C-20	92004
39154	HSK63A x 32mm I.D. - 120mm	32mm	44mm	53mm	120mm	58mm	M20 x 2.0P	16091C-20	92004



# HSK63A SHRINKFIT HOLDERS

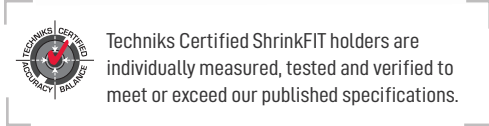

Techniks Certified ShrinkFIT holders are individually measured, tested and verified to meet or exceed our published specifications.

## FEATURES

- Maximum T.I.R. only 0.0001"
- 3 angled CoolBLAST ports direct coolant onto tool
- Coolant-thru stop screw included

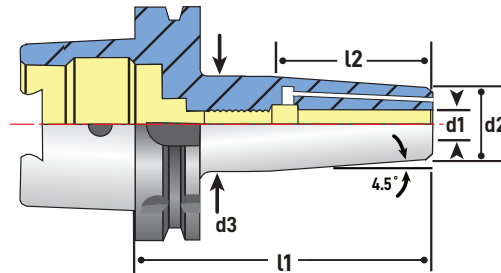

## HSK63A SHRINKFIT HOLDERS COOLBLAST

Part No.	Description	d1	d2	d3	l1	l2	stop screw thread	coolant stop screw	Coolant Pipe
93113B	HSK63A x 1/8" I.D. - 3.15" with CoolBLAST	1/8"	.63"	.87"	3.15"	.79"	M6x1.0P	16081C-20	92004
93114B	HSK63A x 3/16" I.D. - 3.15" with CoolBLAST	3/16"	.63"	.87"	3.15"	.79"	M6 x 1.0P	16082C-20	92004
93115B	HSK63A x 1/4" I.D. - 3.15" with CoolBLAST	1/4"	.83"	1.06"	3.15"	1.42"	M5 x 0.8P	16082C-20	92004
93115-6B	HSK63A x 1/4" I.D. - 6" with CoolBLAST	1/4"	.83"	1.06"	6"	1.42"	M5 x 0.8P	16082C-20	92004
93117B	HSK63A x 3/8" I.D. - 3.35" with CoolBLAST	3/8"	.94"	1.26"	3.35"	1.65"	M8 x 1.25P	16082C-20	92004
93117-6B	HSK63A x 3/8" I.D. - 6" with CoolBLAST	3/8"	.94"	1.26"	6"	1.65"	M8 x 1.25P	16082C-20	92004
93119B	HSK63A x 1/2" I.D. - 3.54" with CoolBLAST	1/2"	1.11"	1.34"	3.54"	1.85"	M10 x 1.5P	16083C-20	92004
93119-6B	HSK63A x 1/2" I.D. - 6" with CoolBLAST	1/2"	1.11"	1.34"	6"	1.85"	M10 x 1.5P	16083C-20	92004
93121B	HSK63A x 5/8" I.D. - 3.74" with CoolBLAST	5/8"	1.06"	1.34"	3.74"	1.97"	M12 x 1.75P	16085C-20	92004
93121-6B	HSK63A x 5/8" I.D. - 6" with CoolBLAST	5/8"	1.06"	1.34"	6"	1.97"	M12 x 1.75P	16085C-20	92004
93124B	HSK63A x 3/4" I.D. - 3.94" with CoolBLAST	3/4"	1.30"	1.65"	3.94"	2.05"	M16 x 2.0P	16089C-20	92004
93124-6B	HSK63A x 3/4" I.D. - 6" with CoolBLAST	3/4"	1.30"	1.65"	6"	2.05"	M16 x 2.0P	16089C-20	92004
93126-6B	HSK63A x 1" I.D. - 6" with CoolBLAST	1"	1.42"	1.65"	6"	2.04"	M20 x 2.0P	16091C-20	92004



SlimPRO Regular

Use SlimPro holders where small nose diameter (d2) tooling is needed.

## HSK63A SHRINKFIT HOLDERS SLIMPRO

Part No.	Description	d1	d2	d3	l1	l2	stop screw thread	coolant stop screw	Coolant Pipe
73528	HSK63A x 1/8" I.D. - 3.15" SlimPRO	1/8"	.35"	.63"	3.15"	.78"	M6x1.0P	16081C-20	92004
73538	HSK63A x 3/16" I.D. - 3.15" SlimPRO	3/16"	.43"	.69"	3.15"	.78"	M6x1.0P	16081C-20	92004
73548	HSK63A x 1/4" I.D. - 3.15" SlimPRO	1/4"	.47"	.81"	3.15"	1.42"	M5x0.8P	16080C-20	92004
73568	HSK63A x 3/8" I.D. - 3.15" SlimPRO	3/8"	.63"	.94"	3.15"	1.65"	M8x1.25P	16082C-20	92004
73588	HSK63A x 1/2" I.D. - 3.15" SlimPRO	1/2"	.71"	1.06"	3.15"	1.85"	M10x1.5P	16083C-20	92004



pg. 119



pg. 115



pg. 229



pg. 236

# HSK100A SHRINKFIT HOLDERS



Techniks Certified ShrinkFIT holders are individually measured, tested and verified to meet or exceed our published specifications.

## FEATURES

- Maximum T.I.R. only 0.0001"
- Balanced 25,000 RPM at G2.5
- Coolant-thru stop screw included

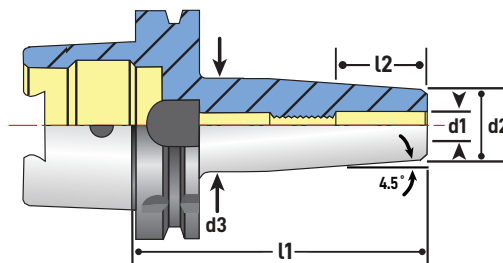

## HSK100A SHRINKFIT HOLDERS

Part No.	Description	d1	d2	d3	l1	l2	stop screw thread	coolant stop screw	Coolant Pipe
39304	HSK100A x 1/8" I.D. - 90mm	1/8"	.35"	.87"	90mm	.79"	M6 x 1.0P	16081C-20	92005
39306	HSK100A x 1/4" I.D. - 90mm	1/4"	.83"	1.06"	90mm	1.42"	M5 x 0.8P	16080C-20	92005
39307	HSK100A x 1/4" I.D. - 160mm	1/4"	.83"	1.06"	160mm	1.42"	M5 x 0.8P	16080C-20	92005
39308	HSK100A x 5/16" I.D. - 85mm	5/16"	.79"	1.06"	85mm	1.42"	M6 x 1.0P	16081C-20	92005
39310	HSK100A x 3/8" I.D. - 90mm	3/8"	.94"	1.26"	90mm	1.65"	M8 x 1.25P	16082C-20	92005
39310-6	HSK100A x 3/8" I.D. - 6"	3/8"	.94"	1.26"	6"	1.65"	M8 x 1.25P	16082C-20	92005
39311	HSK100A x 3/8" I.D. - 160mm	3/8"	.94"	1.26"	160mm	1.65"	M8 x 1.25P	16082C-20	92005
39312	HSK100A x 7/16" I.D. - 95mm	7/16"	.94"	1.26"	95mm	1.85"	M10 x 1.5P	16083C-20	92005
39314	HSK100A x 1/2" I.D. - 95mm	1/2"	1.10"	1.34"	95mm	1.85"	M10 x 1.5P	16083C-20	92005
39315	HSK100A x 1/2" I.D. - 160mm	1/2"	1.10"	1.34"	160mm	1.85"	M10 x 1.5P	16083C-20	92005
39318	HSK100A x 5/8" I.D. - 100mm	5/8"	1.06"	1.34"	100mm	1.97"	M12 x 1.75P	16085C-20	92005
39319	HSK100A x 5/8" I.D. - 160mm	5/8"	1.26"	1.34"	160mm	1.97"	M12 x 1.75P	16085C-20	92005
39320	HSK100A x 3/4" I.D. - 105mm	3/4"	1.42"	1.65"	105mm	2.04"	M16 x 2.0P	16089C-20	92005
39321	HSK100A x 3/4" I.D. - 160mm	3/4"	1.42"	1.65"	160mm	2.04"	M16 x 2.0P	16089C-20	92005
39324	HSK100A x 1" I.D. - 115mm	1"	1.81"	2.09"	115mm	2.28"	M20 x 2.0P	16091C-20	92005
39325	HSK100A x 1" I.D. - 160mm	1"	1.81"	2.09"	160mm	2.28"	M20 x 2.0P	16091C-20	92005
39326	HSK100A x 1-1/4" I.D. - 120mm	1-1/4"	1.81"	2.09"	120mm	2.28"	M20 x 2.0P	16091C-20	92005
39327	HSK100A x 1-1/4" I.D. - 160mm	1-1/4"	1.81"	2.09"	160mm	2.28"	M20 x 2.0P	16091C-20	92005

# HSK100A SHRINKFIT HOLDERS

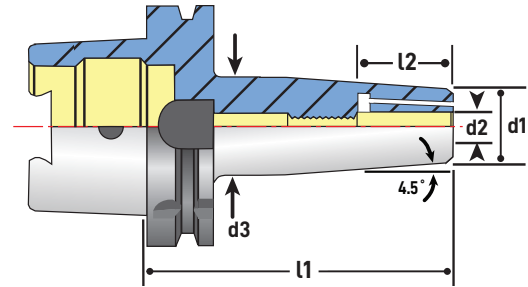

## HSK100A SHRINKFIT HOLDERS COOLBLAST

Part No.	Description	d1	d2	d3	l1	l2	stop screw thread	stop screw thread	Coolant Pipe
39306B	HSK100A x 1/4" I.D. - 90mm w/CoolBLAST	1/4"	.83"	1.06"	90mm	1.42"	M5 x 0.8P	M5 x 0.8P	92005
39307B	HSK100A x 1/4" I.D. - 160mm w/CoolBLAST	1/4"	.83"	1.06"	160mm	1.42"	M5 x 0.8P	M5 x 0.8P	92005
39310B	HSK100A x 3/8" I.D. - 90mm w/CoolBLAST	3/8"	.94"	1.26"	90mm	1.65"	M8 x 1.25P	M8 x 1.25P	92005
39311B	HSK100A x 3/8" I.D. - 160mm w/CoolBLAST	3/8"	.94"	1.26"	160mm	1.65"	M8 x 1.25P	M8 x 1.25P	92005
39314B	HSK100A X 1/2" I.D. - 95mm w/CoolBLAST	1/2"	1.10"	1.34"	95mm	1.85"	M10 x 1.5P	M10 x 1.5P	92005
39315B	HSK100A X 1/2" I.D. - 160mm w/CoolBLAST	1/2"	1.10"	1.34"	160mm	1.85"	M10 x 1.5P	M10 x 1.5P	92005
39318B	HSK100A x 5/8" I.D. - 100mm w/CoolBLAST	5/8"	1.06"	1.34"	100mm	1.97"	M12 x 1.75P	M12 x 1.75P	92005
39319B	HSK100A x 5/8" I.D. - 160mm w/CoolBLAST	5/8"	1.26"	1.34"	160mm	1.97"	M12 x 1.75P	M12 x 1.75P	92005
39320B	HSK100A x 3/4" I.D. - 105mm w/CoolBLAST	3/4"	1.42"	1.65"	105mm	2.04"	M16 x 2.0P	M16 x 2.0P	92005
39321B	HSK100A x 3/4" I.D. - 160mm w/CoolBLAST	3/4"	1.42"	1.65"	160mm	2.04"	M16 x 2.0P	M16 x 2.0P	92005
39324B	HSK100A x 1" I.D. - 115mm w/CoolBLAST	1"	1.81"	2.09"	115mm	2.28"	M20 x 2.0P	M20 x 2.0P	92005
39325B	HSK100A x 1" I.D. - 160mm w/CoolBLAST	1"	1.81"	2.09"	160mm	2.28"	M20 x 2.0P	M20 x 2.0P	92005
39326B	HSK100A x 1-1/4" I.D. - 120mm w/CoolBLAST	1-1/4"	1.81"	2.09"	120mm	2.28"	M20 x 2.0P	M20 x 2.0P	92005
39327B	HSK100A x 1-1/4" - 160mm w/CoolBLAST	1-1/4"	1.81"	2.09"	160mm	2.28"	M20 x 2.0P	M20 x 2.0P	92005



**SHRINK LOCKED™**  
WITH FORMULA TTG 594

### Why Try ShrinkLOCKED?

- Run harder – higher speeds and feeds.
- Never spin or pull out a cutting tool.
- No modification to your tool shank required.
- No impact to accuracy or tool changes.
- Locked drive on standard carbide round shanks.

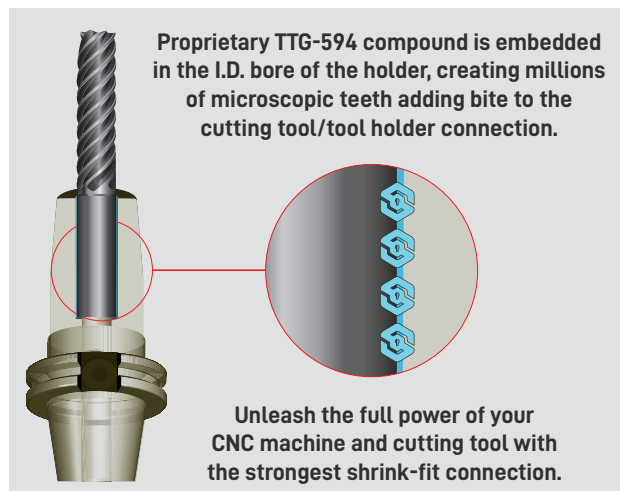



pg. 119



pg. 115



pg. 229



pg. 236

# HSK40E SHRINKFIT HOLDERS



Techniks Certified ShrinkFIT holders are individually measured, tested and verified to meet or exceed our published specifications.

## FEATURES

- Maximum T.I.R. only 0.0001"
- Balanced 25,000 RPM at G2.5
- Coolant-thru stop screw included

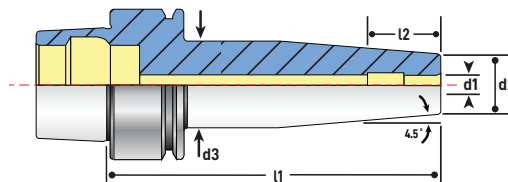

## HSK40E SHRINKFIT HOLDERS

Part No.	Description	d1	d2	d3	l1	l2	stop screw thread	coolant stop screw	Coolant Pipe
39001-E	HSK40E x 1/8" I.D. - 3.54"	1/8"	.36"	.47"	3.54"	.79"	-	-	92002
39002-E	HSK40E x 3/16" I.D. - 3.54"	3/16"	.63"	.71"	3.54"	.79"	-	-	92002
39004-E	HSK40E x 1/4" I.D. - 3.54"	1/4"	.71"	1.06"	3.54"	1.42"	M5 x 0.8P	16080C-20	92002
39006-E	HSK40E x 5/16" I.D. - 3.54"	5/16"	.83"	1.06"	3.54"	1.42"	M6 x 1.0P	16081C-20	92002
39008-E	HSK40E x 3/8" I.D. - 3.54"	3/8"	.94"	1.26"	3.54"	1.65"	M8 x 1.25P	16082C-20	92002
39082-E	HSK40E x 3mm I.D. - 80mm	3mm	9mm	18mm	80mm	18mm	-	-	92002
39084-E	HSK40E x 4mm I.D. - 80mm	4mm	10mm	22mm	80mm	20mm	-	-	92002
39088-E	HSK40E x 6mm I.D. - 80mm	6mm	21mm	27mm	80mm	36mm	M5 x 0.8P	16080C-20	92002
39090-E	HSK40E x 8mm I.D. - 80mm	8mm	21mm	27mm	80mm	36mm	M6 x 1.0P	16081C-20	92002
39092-E	HSK40E x 10mm I.D. - 80mm	10mm	24mm	32mm	85mm	42mm	M8 x 1.25P	16082C-20	92002



Use SlimSlimPRO holders where small nose diameter (d2) tooling is needed.

## HSK40E SHRINKFIT HOLDERS **SLIMPRO**

Part No.	Description	d1	d2	d3	l1	l2	stop screw thread	coolant stop screw	Coolant Pipe
99528	HSK40E x 1/8" I.D. - 2.36" SlimPRO	1/8"	.36"	.63"	2.36"	.78"	M6 x 1.0P	16081C-20	92002
99538	HSK40E x 3/16" I.D. - 2.36" SlimPRO	3/16"	.43"	.69"	2.36"	.78"	M6 x 1.0P	16081C-20	92002
99548	HSK40E x 1/4" I.D. - 2.36" SlimPRO	1/4"	.47"	.81"	2.36"	1.42"	M5 x 0.8P	16080C-20	92002
99568	HSK40E x 3/8" I.D. - 2.36" SlimPRO	3/8"	.63"	.94"	2.36"	1.65"	M8 x 1.25P	16082C-20	92002
99588	HSK40E x 1/2" I.D. - 2.36" SlimPRO	1/2"	.71"	1.06"	2.36"	1.85"	M10 x 1.5P	16083C-20	92002





# HSK63F / HSK50E SHRINKFIT HOLDERS



## FEATURES

- Maximum T.I.R. only 0.0001"
- Balanced 25,000 RPM at G2.5
- Coolant-thru stop screw included

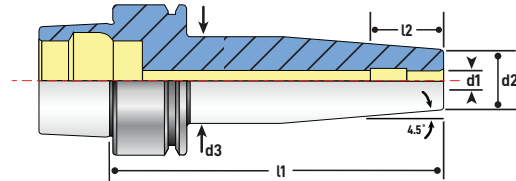

## HSK63F SHRINKFIT HOLDERS

Part No.	Description	d1	d2	d3	l1	l2	stop screw thread	coolant stop screw	Coolant Pipe
71250	HSK63F x 1/4" I.D. - 3.15"	1/4"	.83"	1.06"	3.15"	1.42"	M5 x 0.8P	16080C-20	92004
71312	HSK63F x 5/16" I.D. - 3.74"	5/16"	.79"	1.06"	3.74"	1.42"	M6 x 1.0P	16081C-20	92004
71375	HSK63F x 3/8" I.D. - 3.74"	3/8"	.94"	1.26"	3.74"	1.65"	M8 x 1.25P	16082C-20	92004
71500	HSK63F x 1/2" I.D. - 3.74"	1/2"	.94"	1.26"	3.74"	1.85"	M10 x 1.5P	16083C-20	92004
71625	HSK63F x 5/8" I.D. - 3.74"	5/8"	1.06"	1.34"	3.74"	1.97"	M12 x 1.75P	16085C-20	92004
71750	HSK63F x 3/4" I.D. - 3.94"	3/4"	1.42"	1.65"	3.94"	2.05"	M16 x 2.0P	16089C-20	92004
71100	HSK63F x 1" I.D. - 4.53"	1"	1.42"	1.65"	4.53"	2.28"	M20 x 2.0P	16091C-20	92004
71010	HSK63F x 20mm I.D. - 100mm	20mm	33mm	42mm	100mm	47mm	M16 x 2.0P	16089C-20	92004
71011	HSK63F x 25mm I.D. - 115mm	25mm	44mm	53mm	115mm	58mm	M20 x 2.0P	16091C-20	92004



## FEATURES

- Maximum T.I.R. only 0.0001"
- Balanced 25,000 RPM at G2.5
- Coolant-thru stop screw included

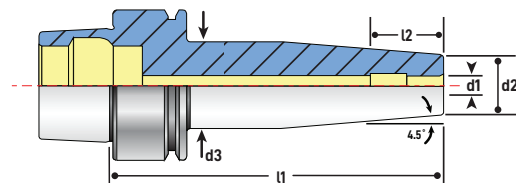

## HSK50E SHRINKFIT HOLDERS

Part No.	Description	d1	d2	d3	l1	l2	stop screw thread	coolant stop screw	Coolant Pipe
39014-E	HSK50E x 1/8" I.D. - 3.15"	1/8"	.36"	.87"	3.15"	.79"	M6 x 1.0P	16081C-20	92003
39016-E	HSK50E x 3/16" I.D. - 3.54"	3/16"	.43"	.87"	3.54"	.79"	M6 x 1.0P	16081C-20	92003
39018-E	HSK50E x 1/4" I.D. - 3.54"	1/4"	.71"	1.06"	3.54"	1.42"	M5 x 0.8P	16080C-20	92003
39020-E	HSK50E x 5/16" I.D. - 3.54"	5/16"	.83"	1.06"	3.54"	1.42"	M6 x 1.0P	16081C-20	92003
39022-E	HSK50E x 3/8" I.D. - 3.54"	3/8"	.94"	1.26"	3.54"	1.65"	M8 x 1.25P	16082C-20	92003
39024-E	HSK50E x 1/2" I.D. - 3.54"	1/2"	1.10"	1.34"	3.54"	1.85"	M10 x 1.5P	16083C-20	92003
39025-E	HSK50E x 5/8" I.D. - 3.54"	5/8"	1.06"	1.34"	3.54"	.97"	M12 x 1.75P	16085C-20	92003

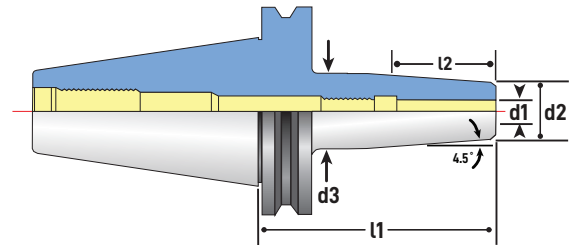

## ISO30 SHRINKFIT HOLDERS

Part No.	Description	d1	d2	d3	l1	l2	stop screw thread	coolant stop screw
64250	ISO30 x 1/4" I.D. - 80mm	1/4"	21mm	27mm	80mm	39mm	M5 x 0.8P	16082C-20
64375	ISO30 x 3/8" I.D. - 80mm	3/8"	24mm	32mm	80mm	42mm	M8 x 1.25P	16082C-20
64500	ISO30 x 1/2" I.D. - 80mm	1/2"	28mm	32mm	80mm	47mm	M10 x 1.5P	16083C-20
64625	ISO30 x 5/8" I.D. - 80mm	5/8"	28mm	32mm	80mm	50mm	M12 x 1.75P	16085C-20
64750	ISO30 x 3/4" I.D. - 80mm	3/4"	33mm	42mm	80mm	52mm	M16 x 2.0P	16089C-20
64110	ISO30 x 1" I.D. - 4"	1"	46mm	53mm	4"	58mm	M20 x 2.0P	16091C-20

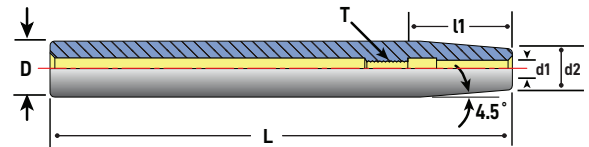

## SHRINKFIT EXTENSIONS

Part No.	Description	D	d1	d2	L	l1	T
86062	5/8" O.D., x 1/8" I.D. - 6.3"	5/8"	1/8"	.394"	6.3"	.79"	-
86064	5/8" O.D., x 3/16" I.D. - 6.3"	5/8"	3/16"	.394"	6.3"	.79"	-
86066	5/8" O.D., x 1/4" I.D. - 6.3"	5/8"	1/4"	.394"	6.3"	.79"	M6x1.0
86076	3/4" O.D., x 1/4" I.D. - 6.3"	3/4"	1/4"	.551"	6.3"	1.42"	M6x1.0
86080	3/4" O.D., x 3/8" I.D. - 6.3"	3/4"	3/8"	.551"	6.3"	1.65"	M8x1.25
86090	1" O.D. x 3/8" I.D. - 6.3"	1"	3/8"	.79"	6.3"	1.65"	M8x1.25
86092	1" O.D. x 1/2" I.D. - 6.3"	1"	1/2"	.79"	6.3"	1.85"	M10x1.5
86094	1" O.D. x 5/8" I.D. - 6.3"	1"	5/8"	.87"	6.3"	1.97"	M12x1.75

## COOLANT PRESET SCREWS

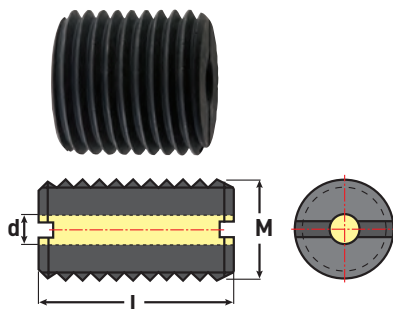

Part No.	Description	M	L	d
16080C-20	Coolant Set Screw	M5 x 0.8P	20mm	2mm
16081C-20	Coolant Set Screw	M6 x 1.0P	20mm	2.5mm
16082C-20	Coolant Set Screw	M8 x 1.25P	20mm	4mm
16083C-20	Coolant Set Screw	M10 x 1.5P	20mm	4mm
16085C-20	Coolant Set Screw	M12 x 1.75P	20mm	4mm
16089C-20	Coolant Set Screw	M16 x 02.0P	20mm	5mm
16091C-20	Coolant Set Screw	M20 x 2.0P	20mm	5mm

# SFS12 MODULAR SHRINKFIT SYSTEM



## FEATURES

- Coolant thru capable
- Balanced to 25,000 RPM @ G2.5
- T.I.R 0.0001" measured from the taper to the I.D.
- Compatible with other modular shrink fit systems

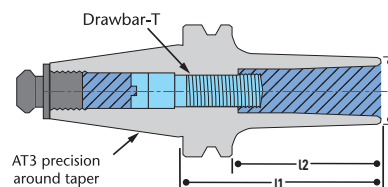

SFS toolholders and ShrinkFIT adapters are made from H13 tool steel for compatibility with fast induction heat shrink machines like Techniks ShrinkPRO unit that provide tool changes in only 3–5 seconds.

Toolholders made from H13 also provide reduced wear on the machine spindle when compared to stainless steel holders.

For shanks from 1/8" to 1/2" using SFS holders.

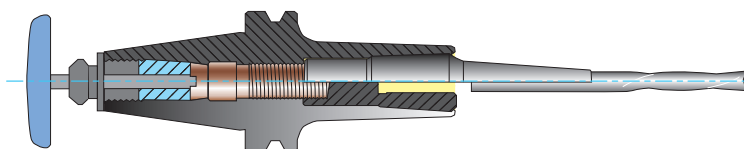

## SFS HOLDERS FOR CAT, BT, HSK

SFS toolholders feature a powerful internal drawbar design for maximum holding power and are coolant-thru capable.

Part No.	Description	l1	l2	D	Drawbar-T
10.780.12.138	BT30 x SFS12 - 1.38"	1.38"	0.51"	1.50"	SFS-M10C-20.6
11.780.12.045	BT40 x SFS12 - 1.77"	1.77"	0.71"	1.50"	SFS-M10C-20.6
31.780.12.177	CAT40 x SFS12 - 1.77"	1.77"	0.34"	1.50"	SFS-M10C-20.6
32.780.12.295	CAT50 x SFS12 - 2.95"	2.95"	1.46"	1.50"	SFS-M10C-20.6
99.780.12.075	HSK40E x SFS12 - 2.95"	2.95"	2.16"	1.50"	SFS-M10C-20.6
73.780.12.075	HSK63A x SFS12 - 2.95"	2.95"	1.85"	1.50"	SFS-M10C-20.6
103.780.12.065	HSK63F x SFS12 - 2.56"	2.56"	1.45"	1.50"	SFS-M10C-20.6
75.780.12.105	HSK100A x SFS12 - 4.13"	4.13"	1.85"	1.50"	SFS-M10C-20.6



pg. 119



pg. 115



pg. 229



pg. 236

# SFS12 MODULAR SHRINKFIT SYSTEM



## FEATURES

- H13 steel for durability and maximum rigidity
- Maximum T.I.R. only 0.0001"
- Coolant thru capable

SFS toolholders and ShrinkFIT adapters are made from H13 tool steel for compatibility with fast induction heat shrink machines like Techniks ShrinkPRO unit that provide tool changes in only 3–5 seconds.

For shanks from 1/8" to 1/2" using SFS holders.

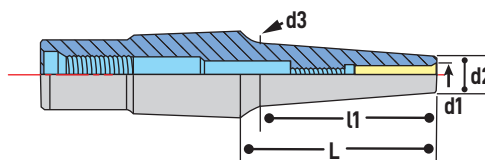

## SFS ADAPTERS INCH

Tighten to 44 ft/lbs

Part No.	Description	d1	d2	d3	L	l1
258.SFS12.52.138	SFS12 x 1/8" - 1.38"	1/8"	.24"	.33"	1.38"	.87"
258.SFS12.53.138	SFS12 x 3/16" - 1.38"	3/16"	.31"	.40"	1.38"	.87"
258.SFS12.54.138	SFS12 x 1/4" - 1.38"	1/4"	.37"	.46"	1.38"	.87"
258.SFS12.56.138	SFS12 x 3/8" - 1.38"	3/8"	.49"	.58"	1.38"	.87"
258.SFS12.58.138	SFS12 x 1/2" - 1.38"	1/2"	.62"	.71"	1.38"	.87"
258.SFS12.52.055	SFS12 x 1/8" - 2.16"	1/8"	.24"	.41"	2.16"	1.65"
258.SFS12.52.055-3	SFS12 x 1/8" - 2.16"	1/8"	.36"	.64"	2.16"	1.65"
258.SFS12.53.055	SFS12 x 3/16" - 2.16"	3/16"	.30"	.48"	2.16"	1.65"
258.SFS12.54.055	SFS12 x 1/4" - 2.16"	1/4"	.37"	.54"	2.16"	1.65"
258.SFS12.56.055	SFS12 x 3/8" - 2.16"	3/8"	.49"	.66"	2.16"	1.65"
258.SFS12.58.055	SFS12 x 1/2" - 2.16"	1/2"	.62"	.79"	2.16"	1.65"
258.SFS12.52.315	SFS12 x 1/8" - 3.15"	1/8"	.24"	.52"	3.15"	2.64"
258.SFS12.53.315	SFS12 x 3/16" - 3.15"	3/16"	.31"	.58"	3.15"	2.64"
258.SFS12.54.315	SFS12 x 1/4" - 3.15"	1/4"	.37"	.64"	3.15"	2.64"
258.SFS12.56.315	SFS12 x 3/8" - 3.15"	3/8"	.49"	.77"	3.15"	2.64"
258.SFS12.58.315	SFS12 x 1/2" - 3.15"	1/2"	.62"	.89"	3.15"	2.64"
258.SFS12.52.433	SFS12 x 1/8" - 4.33"	1/8"	.24"	.64"	4.33"	3.82"
258.SFS12.53.433	SFS12 x 3/16" - 4.33"	3/16"	.31"	.71"	4.33"	3.82"
258.SFS12.54.433	SFS12 x 1/4" - 4.33"	1/4"	.37"	.77"	4.33"	3.82"
258.SFS12.56.433	SFS12 x 3/8" - 4.33"	3/8"	.49"	.89"	4.33"	3.82"
258.SFS12.58.433	SFS12 x 1/2" - 4.33"	1/2"	.62"	1.02"	4.33"	3.82"

# SFS12 MODULAR SHRINKFIT SYSTEM

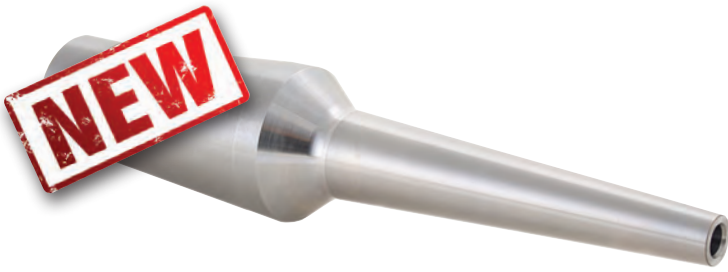

## FEATURES

- H13 steel for durability and maximum rigidity
- Maximum T.I.R. only 0.0001"
- Coolant thru capable

SFS toolholders and ShrinkFIT adapters are made from H13 tool steel for compatibility with fast induction heat shrink machines like Techniks ShrinkPRO unit that provide tool changes in only 3–5 seconds.

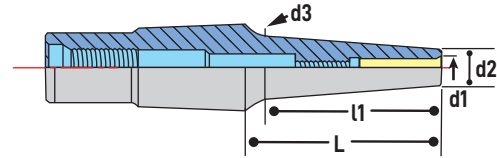

For shanks from 1/8" to 1/2" using SFS holders.

## SFS ADAPTERS METRIC

Part No.	Description	d1	d2	d3	L	l1
258.SFS12.03.035	SFS12 x 3mm - 35mm	3mm	6mm	8.3mm	35mm	22mm
258.SFS12.04.035	SFS12 x 4mm - 35mm	4mm	7mm	9.3mm	35mm	22mm
258.SFS12.06.035	SFS12 x 6mm - 35mm	6mm	9mm	11.3mm	35mm	22mm
258.SFS12.08.035	SFS12 x 8mm - 35mm	8mm	11mm	13.3mm	35mm	22mm
258.SFS12.10.035	SFS12 x 10mm - 35mm	10mm	13mm	15.3mm	35mm	22mm
258.SFS12.12.035	SFS12 x 12mm - 35mm	12mm	15mm	17.3mm	35mm	22mm
258.SFS12.03.055	SFS12 x 3mm - 55mm	3mm	6mm	10.4mm	55mm	42mm
258.SFS12.04.055	SFS12 x 4mm - 55mm	4mm	7mm	11.4mm	55mm	42mm
258.SFS12.06.055	SFS12 x 6mm - 55mm	6mm	9mm	13.4mm	55mm	42mm
258.SFS12.08.055	SFS12 x 8mm - 55mm	8mm	11mm	15.4mm	55mm	42mm
258.SFS12.10.055	SFS12 x 10mm - 55mm	10mm	13mm	17.4mm	55mm	42mm
258.SFS12.12.055	SFS12 x 12mm - 55mm	12mm	15mm	19.4mm	55mm	42mm
258.SFS12.03.080	SFS12 x 3mm - 80mm	3mm	6mm	13mm	80mm	67mm
258.SFS12.04.080	SFS12 x 4mm - 80mm	4mm	7mm	14mm	80mm	67mm
258.SFS12.06.080	SFS12 x 6mm - 80mm	6mm	9mm	16.2mm	80mm	67mm
258.SFS12.08.080	SFS12 x 8mm - 80mm	8mm	11mm	18mm	80mm	67mm
258.SFS12.10.080	SFS12 x 10mm - 80mm	10mm	13mm	20mm	80mm	67mm
258.SFS12.03.110	SFS12 x 3mm - 110mm	3mm	6mm	16.2mm	110mm	97mm
258.SFS12.04.110	SFS12 x 4mm - 110mm	4mm	7mm	17.2mm	110mm	97mm
258.SFS12.06.110	SFS12 x 6mm - 110mm	6mm	9mm	19.2mm	110mm	97mm
258.SFS12.08.110	SFS12 x 8mm - 110mm	8mm	11mm	21.2mm	110mm	97mm
258.SFS12.10.110	SFS12 x 10mm - 110mm	10mm	13mm	23.1mm	110mm	97mm
258.SFS12.12.110	SFS12 x 12mm - 110mm	12mm	15mm	25.2mm	110mm	97mm



pg. 119



pg. 115



pg. 229



pg. 236

# SHRINKSTATION SHRINKFIT MACHINES



## 00400 SHRINKSTATION

### FEATURES

- Induction coil technology enables tool changes in 15-20 seconds
- Easy to use touch screen design
- Automatically aligns tool holder with the induction head
- Heating time is automatically set by tool diameter
- Cooling cycle uses shop air
- Tool lengths up to 22"



The ShrinkSTATION 400 comes with a NEMA L16-15P plug installed. Requires a NEMA L16-15R receptacle (not included).

Part No.	Tool Diameters	Power	L x D x H	Ship Wt.
00400	1/8" - 1-1/4"	220V, 15A, 1 phase	16"x 16"x 22"	70 lbs



## 00450 SHRINKSTATION

**MORE POWER COMPACT SHRINKSTATION**

### FEATURES

- Induction coil technology enables tool changes in 6-8 seconds
- Easy to use touch screen design
- Automatically aligns tool holder with the induction head
- Heating time is automatically set by tool diameter
- Cooling cycle uses shop air
- Tool lengths up to 22"



The ShrinkSTATION 450 comes with a NEMA L16-20P plug installed. Requires either a NEMA L16-20R or L6-15R receptacle (not included).

Part No.	Tool Diameters	Power	L x D x H	Ship Wt.
00450	1/8" - 1-1/4"	440V - 480V, 20A, 3 phase	16"x 16"x 22"	70 lbs

### EACH SHRINKSTATION INCLUDES:

Part No.	Description
00600-00165	Induction Ring (3 - 5mm shanks)
00600-00166	Induction Ring (6 - 12mm shanks)
00600-00167	Induction Ring (14 - 20mm shanks)
00600-00168	Induction Ring (25 - 32mm shanks)
385-11878-2	Tool Holder Adapter - 40 taper & C6
385-11878-1	Tool Holder Adapter - 50 taper
385-11878-7	Tool Holder Adapter - HSK63
26139-L	Thermal Insulated Glove

### ADDITIONAL OPTIONS AVAILABLE:

Part No.	Description
385-11878-9	Tool Holder Adapter - 30 taper
385-11878-6	Tool Holders Adapter - HSK40 & C4
385-11878-8	Tool Holder Adapter - HSK50 & C5
00400/00450-EP	Extension Pedestal for long tool holders







## 00600 SHRINKPRO

### FEATURES

- Induction coil technology enables tool changes in 3-6 seconds
- Easy to use touch screen design
- Heating time is automatically set by tool diameter
- Cooling cycle uses shop air

### EASY-TO-USE TOUCHSCREEN



Select your shank size and ShrinkPRO sets heating duration

### PRODUCT SPECS

Part No.	Tool Diameters	Power	L x D x H	Ship Wt.
00600	1/8" -1-1/4"	480V, 20A, 3 phase	20" x 20" x 37"	84 lbs



## 00500 SHRINKPRO QUENCHER

### FEATURES

- Induction coil technology enables tool changes in 3-6 seconds
- Easy to use touch screen design
- Heating time is automatically set by tool diameter
- Coolant bath and air-drying system cools tools in under 30 seconds

Quencher features a liquid cooling cycle that is **250% FASTER** than air-cooled units.

### PRODUCT SPECS

Part No.	Tool Diameters	Power	L x D x H	Ship Wt.
00500	1/8" -1-1/4"	480V, 20A, 3 phase	37" x 24" x 71"	660 lbs

#### EACH SHRINKPRO AND QUENCHER SHIPS WITH:

Part No.	Description
00600-00165	Induction Ring (3 - 5mm shanks)
00600-00166	Induction Ring (6 - 12mm shanks)
00600-00167	Induction Ring (14 - 20mm shanks)
00600-00168	Induction Ring (25 - 32mm shanks)
00600-9006	Tool Holder Adapter – HSK63/HSK100
00600-9002	Tool Holder Adapter – 40 taper
00600-9003	Tool Holder Adapter – HSK40
00600-9004	Tool Holder Adapter – HSK50
00600-9005	Tool Holder Adapter – 30 taper
00600-9006	Tool Holder Adapter – PSC6
26139-L	Thermal Insulated Glove

#### EACH QUENCHER SHIPS WITH:

Part No.	Description
00500-C	1 Gallon Quencher Coolant

#### "NEVER DOWN" GUARANTEE

We stand behind our products 100% and expect them to out-perform the competition. Purchase any Techniks ShrinkFIT machine with confidence knowing that we can provide a backup if yours should ever need servicing!

Replacement machine is on loan until original is repaired and back in service. Replacement machines are limited to standard configuration. Power requirements may vary from original machine. Replacements are subject to availability. Extended Warranties are also available.



# EXTREME PRECISION HYDRAULIC HOLDERS

HOLDING POWER AND ACCURACY FOR ALL TYPES OF APPLICATIONS.

**NEW**

**TRITON**

## TRITON HYDRAULIC HOLDERS

THE NEW FORCE IN HYDRAULIC CHUCK TECHNOLOGY!



- Newly designed hydraulic system provides 3.5X clamping force of standard hydraulic chucks
- Bore wall is up to 74% thicker than standard hydraulic holders, for improved rigidity in heavy stock removal applications
- Excellent vibration damping properties enhances surface finishes and extends tool life
- Use reduction sleeves to hold any shank diameter

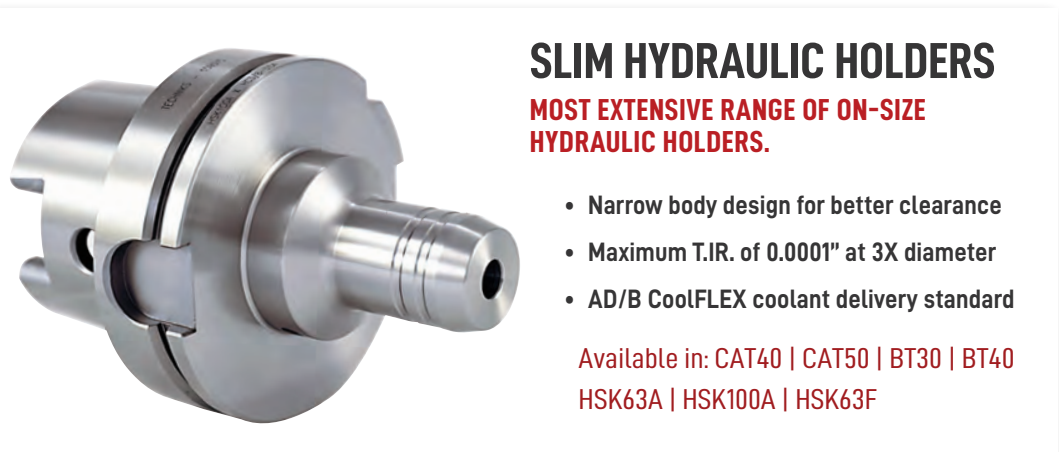

## SLIM HYDRAULIC HOLDERS

MOST EXTENSIVE RANGE OF ON-SIZE HYDRAULIC HOLDERS.

- Narrow body design for better clearance
- Maximum T.I.R. of 0.0001" at 3X diameter
- AD/B CoolFLEX coolant delivery standard

Available in: CAT40 | CAT50 | BT30 | BT40  
HSK63A | HSK100A | HSK63F

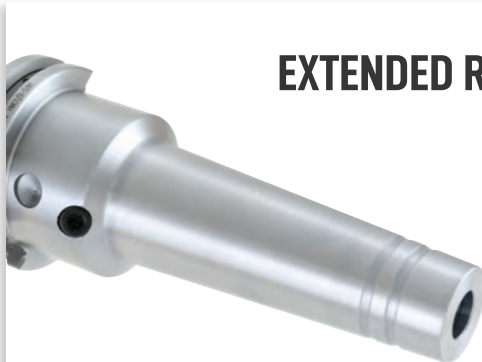

## EXTENDED REACH HYDRAULIC HOLDERS

- Narrow nose diameter for best clearance in close tolerance applications
- Tapered body design enhances rigidity
- Excellent for mold work or anytime you need superior surface finish and accurate cutting at extended lengths



## TRITON HYDRAULIC CHUCKS

- Featuring a newly designed hydraulic bladder system Triton provides 3.5X clamping force of standard hydraulic chucks
- Bore wall thickness is up to **74%** thicker than standard hydraulic holders for improved rigidity in heavy stock removal applications
- Excellent vibration damping properties improves surface finish and tool life
- Use reduction sleeves for any shank diameter

Think hydraulic chucks are just for light milling or finishing passes? THINK AGAIN!

The NEW Triton Chucks by Techniks harness the full power of hydraulic technology to provide unmatched holding power and accuracy!

A newly designed hydraulic system enhances holding power on the tool shank by 350% vs. standard hydraulic chucks.

### Unleash the Hydraulic Power of Triton Chucks!

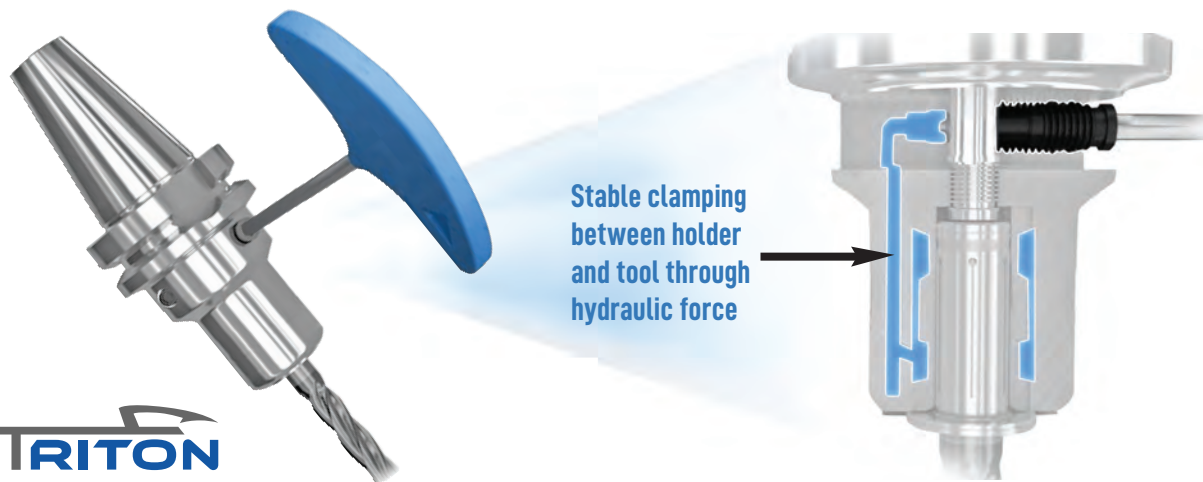



pg. 229



pg. 236



pg. 238



# TRITON HYDRAULIC CHUCKS

- Triton's hydraulic design provides excellent vibration damping properties, so tools run longer and quieter and produce superior surface finishes
- Tool changes are a snap! Only require hex wrench – NO tightening fixtures or torque wrenches needed
- Triton chucks are charged with hydraulic fluid in a vacuum chamber to eliminate air and gas from the system. Coupled with a redesigned oil sealing system, Triton chucks are built to provide maximum holding power for years!
- Use reduction sleeves to hold any shank diameter
- H-LOCKED reduction sleeves are manufactured with patented TTG-594 for unmatched holding power

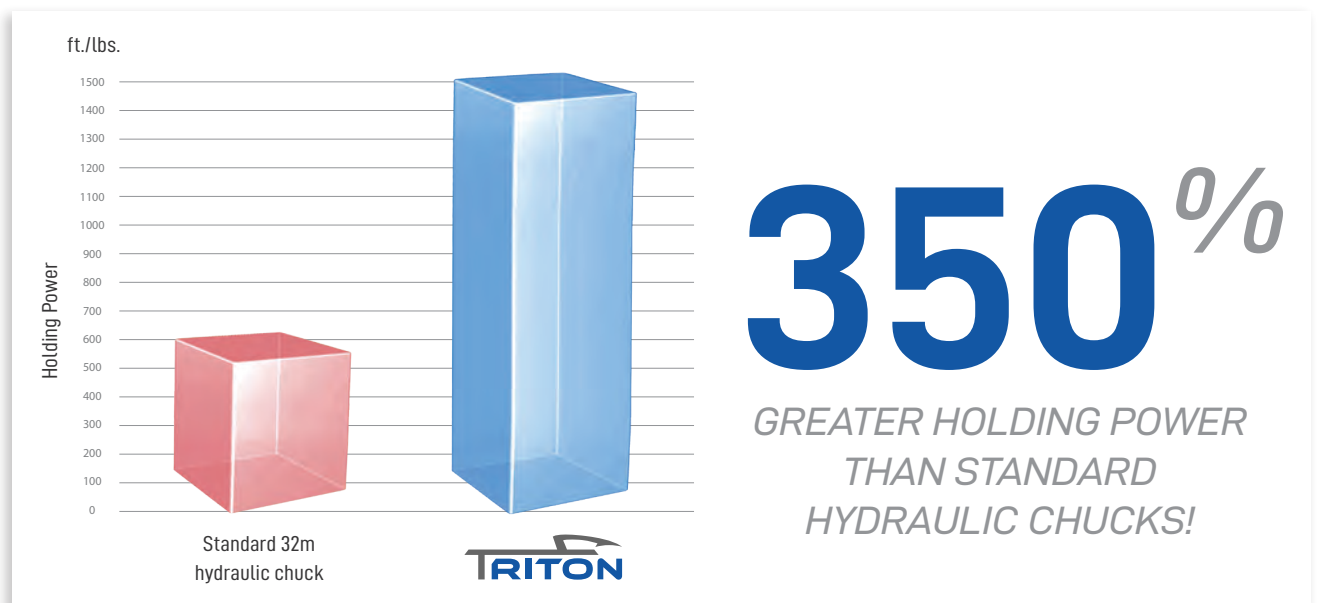



## FEATURES

- 3.5X clamping force of standard hydraulic chucks
- 74% thicker bore walls improve rigidity in heavy material removal applications
- Excellent vibration dampening properties enhances surface finish and extends tool life

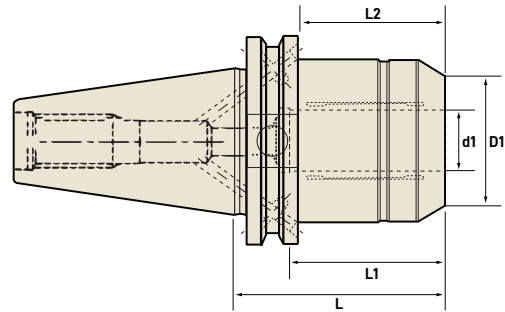

## CAT 40 TRITON HYDRAULIC CHUCKS

Part No.	Description	d1	D1	L	L1	L2	Thread
254750	CAT40 x 3/4" - 2.54" Triton Chuck	3/4"	1.94"	2.54"	1.79"	1.89"	M8x1.0
354750	CAT40 x 3/4" - 4" Triton Chuck	3/4"	1.94"	4"	3.25"	1.89"	M8x1.0
254020	CAT40 x 20mm - 64.5mm Triton Chuck	20mm	49.2mm	64.5mm	45.4mm	48mm	M8x1.0
354020	CAT40 x 20mm - 101.6mm Triton Chuck	20mm	49.2mm	101.6mm	82.6mm	48mm	M8x1.0

## CAT40 TRITON HYDRAULIC CHUCKS **DUALDRIVE**

Part No.	Description	d1	D1	L	L1	L2	Thread
264750	CAT40 x 3/4" - 2.54" Triton Chuck w/ DualDRIVE	3/4"	1.94"	2.54"	1.79"	1.89"	M8x1.0
364750	CAT40 x 3/4" - 4" Triton Chuck w/ DualDRIVE	3/4"	1.94"	4"	3.25"	1.89"	M8x1.0
264020	CAT40 x 20mm - 64.5mm Triton Chuck w/ DualDRIVE	20mm	49.2mm	64.5mm	45.4mm	48mm	M8x1.0
364020	CAT40 x 20mm - 101.6mm Triton Chuck w/ DualDRIVE	20mm	49.2mm	101.6mm	82.6mm	48mm	M8x1.0

## CAT50 TRITON HYDRAULIC CHUCKS

Part No.	Description	d1	D1	L	L1	L2	Thread
255750	CAT50 x 3/4" - 3.19" Triton Chuck	3/4"	1.94"	3.19"	2.44"	1.89"	M8x1.0
255125	CAT50 x 1-1/4" - 3.19" Triton Chuck	1-1/4"	2.84"	3.19"	2.44"	2.24"	M8x1.0
355125	CAT50 x 1-1/4" - 6" Triton Chuck	1-1/4"	2.84"	6"	5.25"	2.24"	M8x1.0
255032	CAT50 x 32mm - 81mm Triton Chuck	32mm	72mm	81mm	61.9mm	48mm	M8x1.0
355032	CAT50 x 32mm - 152.4mm Triton Chuck	32mm	72mm	152.4mm	133.4mm	56.5mm	M8x1.0





pg. 229



pg. 236



pg. 238

# TRITON HYDRAULIC HOLDERS

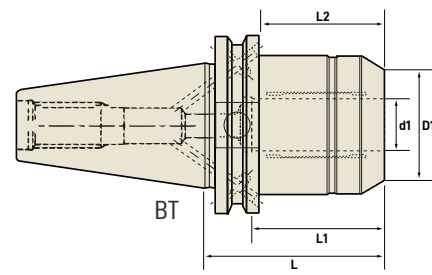
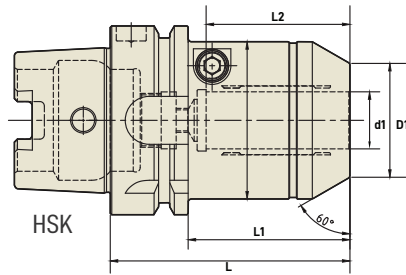

## HSK63A TRITON HYDRAULIC CHUCKS

Part No.	Description	d1	D1	L	L1	L2	Thread
257750	HSK63A x 3/4" - 3.15" Triton Chuck	3/4"	2.07"	3.15"	2.13"	1.89"	M8x1.0
357750	HSK63A x 3/4" - 5.12" Triton Chuck	3/4"	2.07"	5.12"	4.09"	1.89"	M8x1.0
257020	HSK63A x 20mm - 80mm Triton Chuck	20mm	52.5mm	80mm	54mm	48mm	M8x1.0

## HSK100A TRITON HYDRAULIC CHUCKS

Part No.	Description	d1	D1	L	L1	L2	Thread
259125	HSK100A x 1-1/4" - 3.94" Triton Chuck	1-1/4"	2.3"	5.12"	3.98"	2.24"	M8x1.0
259020	HSK100A x 20mm - 90mm Triton Chuck	20mm	52.5mm	90mm	61mm	48mm	M8x1.0
259032	HSK100A x 32mm - 100mm Triton Chuck	32mm	58.5mm	100mm	80mm	57mm	M8x1.0

## BT30 TRITON HYDRAULIC CHUCKS

Part No.	Description	d1	D1	L	L1	L2	Thread
253750	BT30 x 3/4" - 3.54" Triton Chuck	3/4"	1.65"	3.54"	2.68"	1.89"	M8x1.0
253020	BT30 x 20mm - 90mm Triton Chuck	20mm	42mm	90mm	68mm	48mm	M8x1.0

## BT30 TRITON HYDRAULIC CHUCKS **DUALDRIVE**

Part No.	Description	d1	D1	L	L1	L2	Thread
263750	BT30 x 3.4" - 3.54" Triton Chuck w/DualDRIVE	3/4"	1.65"	3.54"	2.68"	1.89"	M8x1.0
263020	BT30 x 20mm - 90mm Triton Chuck w/ DualDRIVE	20mm	42mm	90mm	68mm	48mm	M8x1.0

## BT40 TRITON HYDRAULIC CHUCKS

Part No.	Description	d1	D1	L	L1	L2	Thread
256750	BT40 x 3.4" - 2.85" Triton Chuck	3/4"	1.94"	2.85"	1.79"	1.89"	M8x1.0
256020	BT40 x 20mm - 72.5mm Triton Chuck	20mm	49.2mm	72.5mm	45.5mm	48mm	M8x1.0

## BT40 TRITON HYDRAULIC CHUCKS **DUALDRIVE**

Part No.	Description	d1	D1	L	L1	L2	Thread
266750	BT40 x 3.4" - 2.85" Triton Chuck w/ DualDRIVE	3/4"	1.94"	2.85"	1.79"	1.89"	M8x1.0
266020	BT40 x 20mm - 72.5mm Triton Chuck w/ DualDRIVE	20mm	49.2mm	72.5mm	1.79"	1.89"	M8x1.0





# CAT40 SLIM & EXTENDED HYDRAULIC HOLDERS

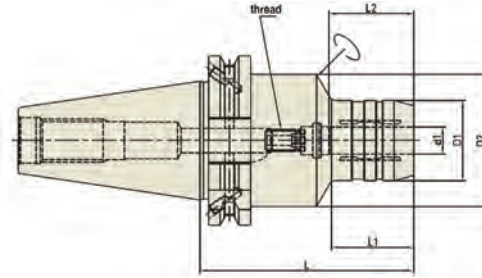

## CAT40 SLIM HYDRAULIC HOLDERS

Part No.	Description	d1	D1	D2	L	L1	L2	Thread
154500	CAT40 AD/B x HC 1/2"S - 2.52"	1/2"	1.654"	-	2.520"	-	1.457"	M10x1.0
154625	CAT40 AD/B x HC 5/8"S - 2.52"	5/8"	1.339"	1.772"	2.520"	-	1.654"	M12x1.0
154750	CAT40 AD/B x HC 3/4"S - 2.52"	3/4"	1.496"	1.969"	2.520"	-	1.654"	M16x1.0
154100	CAT40 AD/B x HC 1"S - 3.5"	1"	2.244"	2.598"	3.504"	-	1.890"	M16x1.0
154060	CAT40 AD/B x HC 6mmS - 80.5mm	6mm	26mm	50mm	80.5mm	20mm	27mm	M5x0.8
154080	CAT40 AD/B x HC 8mmS - 80.5mm	8mm	28mm	50mm	80.5mm	30mm	37mm	M12x1.0
154010	CAT40 AD/B x HC 10mmS - 80.5mm	10mm	30mm	50mm	80.5mm	32mm	32mm	M8x1.0
154012	CAT40 AD/B x HC 12mmS - 80.5mm	12mm	32mm	50mm	80.5mm	32mm	37mm	M10x1.0
154016	CAT40 AD/B x HC 16mmS - 80.5mm	16mm	38mm	50mm	80.5mm	33mm	42mm	M12x1.0
154020	CAT40 AD/B x HC 20mmS - 64.5mm	20mm	37mm	50mm	64.5mm	34mm	42mm	M16x1.0
154200	CAT40 AD/B x HC 20mmS - 80.5mm	20mm	42mm	50mm	80.5mm	34mm	42mm	M16x1.0

## CAT40 EXTENDED REACH HYDRAULIC HOLDERS

Part No.	Description	d1	D1	D2	L	L1	L2	Thread
854022	CAT40 AD/B x HMC 1/4" - 4.72"	1/4"	.787"	1.969"	4.724"	2.756"	1.063"	M5x0.8
854024	CAT40 AD/B x HMC 1/4" - 5.91"	1/4"	.787"	1.969"	5.906"	3.937"	1.063"	M5x0.8
854028	CAT40 AD/B x HMC 3/8" - 4.72"	3/8"	.945"	1.969"	4.724"	2.756"	1.260"	M8x1.0
854030	CAT40 AD/B x HMC 3/8" - 5.91"	3/8"	.945"	1.969"	5.906"	3.937"	1.260"	M8x1.0
854032	CAT40 AD/B x HMC 1/2" - 4.72"	1/2"	1.024"	1.969"	4.724"	2.756"	1.457"	M10x1.0
854034	CAT40 AD/B x HMC 1/2" - 5.91"	1/2"	1.024"	1.969"	5.906"	3.937"	1.457"	M10x1.0
854036	CAT40 AD/B x HMC 5/8" - 4.72"	5/8"	1.260"	1.969"	4.724"	2.756"	1.654"	M12x1.0
854038	CAT40 AD/B x HMC 5/8" - 5.91"	5/8"	1.260"	1.969"	5.906"	3.937"	1.654"	M12x1.0
854040	CAT40 AD/B x HMC 3/4" - 4.72"	3/4"	1.339"	1.969"	4.724"	2.756"	1.654"	M16x1.0
854042	CAT40 AD/B x HMC 3/4" - 5.91"	3/4"	1.339"	1.969"	5.906"	3.937"	1.654"	M16x1.0



pg. 229



pg. 236



pg. 238

# CAT50 / BT30 / BT40 SLIM HYDRAULIC HOLDERS

## CAT50 SLIM HYDRAULIC HOLDERS

Part No.	Description	d1	D1	D2	L	L1	L2	Thread
155750	CAT50 AD/B x HC 3/4"S - 3.19"	3/4"	2.205"	2756"	3.189"	0	1.654"	M16x1.0
155100	CAT50 AD/B x HC 1"S - 3.19"	1"	2.165"	2.765"	3.189"	0	1.890"	M16x1.0
155125	CAT50 AD/B x HC 1-1/4"S - 3.19"	1-1/4"	2.165"	2.765"	3.189"	0	2.165"	M16x1.0
155060	CAT50 AD/B x HC 6mmS - 80.5mm	6mm	26mm	50mm	80.5mm	30mm	27mm	M5x0.8
155080	CAT50 AD/B x HC 8mmS - 80.5mm	8mm	28mm	50mm	80.5mm	30mm	27mm	M12x1.0
155010	CAT50 AD/B x HC 10mmS - 80.5mm	10mm	30mm	50mm	80.5mm	32mm	32mm	M8x1.0
155012	CAT50 AD/B x HC 12mmS - 80.5mm	12mm	32mm	50mm	80.5mm	35mm	37mm	M10x1.0
155016	CAT50 AD/B x HC 16mmS - 80.5mm	16mm	38mm	50mm	80.5mm	40mm	42mm	M12x1.0
155200	CAT50 AD/B x HC 20mmS - 80.5mm	20mm	42mm	50mm	80.5mm	40mm	42mm	M16x1.0

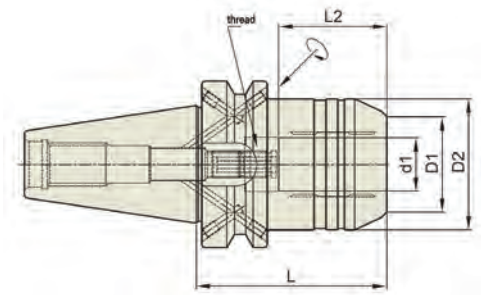

## BT30 SLIM HYDRAULIC HOLDERS

Part No.	Description	d1	D1	D2	L	L1	L2	Thread
153250	BT30 AD/B x HC 1/4"S - 2.75"	1/4"	1.024"	1.772"	2.756"	1.142"	1.063"	M5x0.8
153312	BT30 AD/B x HC 5/16"S - 2.75"	5/16"	1.102"	1.772"	2.756"	1.181"	1.063"	M6x1.0
153375	BT30 AD/B x HC 3/8"S - 2.95"	3/8"	1.181"	1.772"	2.953"	1.220"	1.260"	M8x1.0
153500	BT30 AD/B x HC 1/2"S - 3.35"	1/2"	1.260"	1.772"	3.346"	1.575"	1.457"	M10x1.0
153675	BT30 AD/B x HC 5/8"S - 3.54"	5/8"	1.496"	1.772"	3.543"	1.811"	1.654"	M6x1.0
153750	BT30 AD/B x HC 3/4"S - 3.54"	3/4"	1.654"	1.772"	3.543"	1.890"	1.654"	M6x1.0

## BT40 SLIM HYDRAULIC HOLDERS

Part No.	Description	d1	D1	D2	L	L1	L2	Thread
156250	BT40 AD/B x HC 1/4"S - 3.54"	1/4"	1.024"	1.772"	3.543"	1.181"	1.063"	M5x0.8
256312	BT40 AD/B x HC 5/16"S - 3.54"	5/16"	1.102"	1.772"	3.543"	1.299"	1.063"	M6x1.0
156375	BT40 AD/B x HC 3/8"S - 3.54"	3/8"	1.181"	1.772"	3.543"	1.260"	1.260"	M8x1.0
156500	BT40 AD/B x HC 1/2"S - 3.54"	1/2"	1.260"	1.772"	3.543"	1.378"	1.457"	M10x1.0
156625	BT40 AD/B x HC 5/8"S - 3.54"	5/8"	1.496"	1.890"	3.543"	1.575"	1.654"	M12x1.0
156750	BT40 AD/B x 3/4"S - 3.54"	3/4"	1.654"	1.890"	3.543"	1.575"	1.654"	M16x1.0
156100	BT40 AD/B x HC 1"S - 3.94"	1"	1.969"	2.362"	3.937"	1.772"	1.890"	M16x1.0



# HS63A/F SLIM & EXTENDED HYDRAULIC HOLDERS

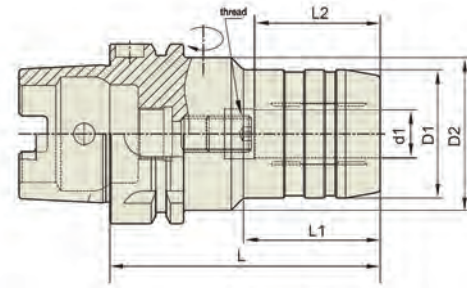

## HSK63A SLIM HYDRAULIC HOLDERS

Part No.	Description	d1	D1	D2	L	L1	L2	Thread
157250	HSK63A x HC 1/4"S - 2.76"	1/4"	1.024"	1.969"	2.756"	.945"	1.063"	M5x0.8
157500	HSK63A x HC 1/2"S - 3.35"	1/2"	1.260"	1.969"	3.346"	1.575"	1.457"	M10x1.0
157750	HSK63A x HC 3/4"S - 3.54"	3/4"	1.654"	1.969"	3.543"	1.890"	1.654"	M16x1.0
157100	HSK63A x HC 1"S - 4.72"	1"	2.244"	2.480"	4.724"	2.323"	1.890"	M16x1.0
157125	HSK63A x HC 1-1/4"S - 4.92"	1-1/4"	2.520"	2.953"	4.921"	2.480"	2.165"	M16x1.0
157060	HSK63A x HC 6mmS - 70mm	6mm	26mm	50mm	70mm	24mm	27mm	M5x0.8
157080	HSK63A x HC 8mmS - 70mm	8mm	28mm	50mm	70mm	25mm	27mm	M6x1.0
157010	HSK63A x HC 10mmS - 80mm	10mm	30mm	50mm	80mm	35mm	32mm	M8x1.0
157012	HSK63A x HC 12mmS - 85mm	12mm	32mm	50mm	85mm	40mm	37mm	M10x1.0
157014	HSK63A x HC 14mmS - 85mm	14mm	34mm	50mm	85mm	40mm	37mm	M10x1.0
157016	HSK63A x HC 16mmS - 90mm	16mm	38mm	50mm	90mm	46mm	42mm	M12x1.0
157018	HSK63A x HC 18mmS - 90mm	18mm	40mm	50mm	90mm	47mm	42mm	M12x1.0
157200	HSK63A x HC 20mmS - 80mm	20mm	53mm	53mm	80mm	47mm	42mm	M16x1.0
157020	HSK63A x HC 20mmS - 90mm	20mm	42mm	50mm	90mm	48mm	42mm	M16x1.0
157025	HSK63A x HC 25mmS - 120mm	25mm	57mm	63mm	120mm	59mm	48mm	M16x1.0
157032	HSK63A x HC 32mmS - 125mm	32mm	64mm	75mm	125mm	63mm	55mm	M16x1.0

## HSK63A EXTENDED REACH HYDRAULIC HOLDERS

Part No.	Description	d1	D1	D2	L	L1	L2	Thread
158250	HSK63A x HMC 1/4" - 5.71"	1/4"	.787"	1.969"	5.709"	3.543"	1.063"	M5x0.8
158312	HSK63A x HMC 5/16" - 5.71"	5/16"	.866"	1.969"	5.709"	3.543"	1.063"	M6x1.0
158375	HSK63A x HMC 3/8" - 5.71"	3/8"	.945"	1.969"	5.709"	3.543"	1.063"	M8x1.0
158500	HSK63A x HMC 1/2" - 5.71"	1/2"	1.024"	1.969"	5.709"	3.543"	1.063"	M10x1.0
158625	HSK63A x HMC 5/8" - 5.71"	5/8"	1.260"	1.969"	5.709"	3.543"	1.063"	M12x1.0
158750	HSK63A x HMC 3/4" - 5.71"	3/4"	1.339"	1.969"	5.709"	3.543"	1.063"	M16x1.0
157220	HSK63A x HMC 20mm - 145mm	20mm	34mm	53mm	145mm	90mm	42mm	M16x1.0

## HSK63F SLIM HYDRAULIC HOLDERS

Part No.	Description	d1	D1	D2	L	L1	L2	Thread
160750	HSK63F x HC 3/4"S - 3.35"	3/4"	1.654"	1.969"	3.346"	1.693"	1.654"	M16x1.0
160100	HSK63F x HC 1"S - 4.72"	1"	2.244"	2.480"	4.724"	2.323"	1.575"	M16x1.0



pg. 229



pg. 236



pg. 238

# HSK100A SLIM HYDRAULIC HOLDERS

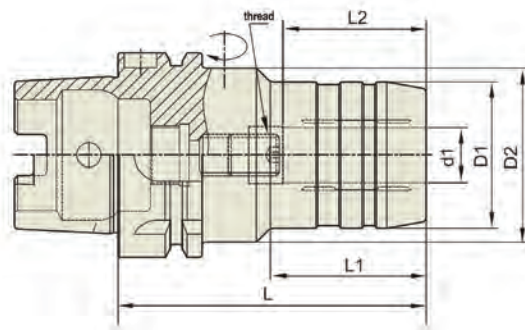

## HSK100A SLIM HYDRAULIC HOLDERS

Part No.	Description	d1	D1	D2	L	L1	L2	Thread
159250	HSK100A x HC 1/4"S - 2.95"	1/4"	1.024"	1.969"	2.953"	.945"	1.063"	M5x0.8
159375	HSK100A x HC 3/8"S - 3.54"	3/8"	1.181"	1.969"	3.543"	1.654"	1.260"	M8x1.0
159500	HSK100A x HC 1/2"S - 3.74"	1/2"	1.260"	1.969"	3.740"	1.850"	1.457"	M10x1.0
159750	HSK100A x HC 3/4"S - 4.13"	3/4"	1.654"	1.969"	4.133"	2.322"	1.654"	M16x1.0
159100	HSK100A x HC 1"S - 4.33"	1"	2.244"	2.480"	4.331"	2.441"	1.890"	M16x1.0
159125	HSK100A x HC 1-1/4"S - 4.33"	1-1/4"	2.520"	2.953"	4.331"	2.441"	2.165"	M16x1.0
159200	HSK100A x HC 20mmS - 90mm	20mm	42mm	50mm	90mm	47mm	42mm	M16x1.0



### Extended Reach

Extended length hydraulic holders are a great choice for mould work, or any time you need smooth, accurate cutting at extended lengths.

### Fast Tool Changes

Fast tool changes are performed with just a twist of a wrench (included). Reduction sleeves fit virtually any shank size.

**Techniks hydraulic holders have the holding power and accuracy for all types of applications.**

Drilling

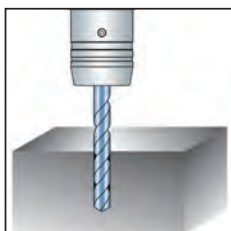

Face &amp; Edge milling

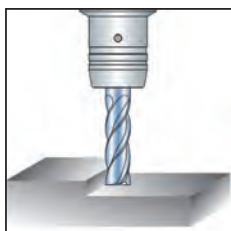

Chamfering

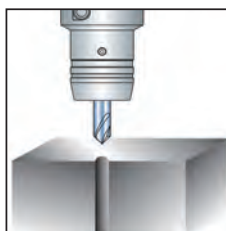

Reaming

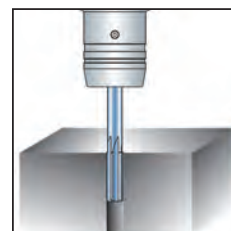

# REDUCTION SLEEVES FOR HYDRAULIC CHUCKS



## FEATURES

- I.D. sizes of 1/2" or 12mm and above are **H-LOCKED** with our patented TTG-594 compound to create the world's strongest gripping force of any hydraulic chuck
- Maximum 0.0001" T.I.R.
- Sealed for coolant-through applications

## H-LOCKED WITH TTG-594™

Unleash the full power of your CNC machine and cutting tool with the strongest gripping connection.

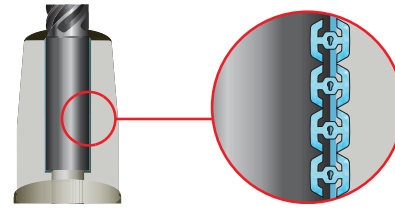

Our proprietary TTG-594 compound is embedded in the I.D. bore of the sleeve, creating millions of microscopic teeth adding bite to the cutting tool/tool holder connection.

### 1/2" O.D. Reduction Sleeves

Part No.	Description, O.D. - I.D.
620108	1/2" - 1/8" Reduction Sleeve
620104	1/2" - 1/4" Reduction Sleeve
620316	1/2" - 3/16" Reduction Sleeve
620516	1/2" - 5/16" Reduction Sleeve

### 20mm O.D. Reduction Sleeves

Part No.	Description, O.D. - I.D.
820030	20mm - 3mm Reduction Sleeve
820040	20mm - 4mm Reduction Sleeve
820050	20mm - 5mm Reduction Sleeve
820060	20mm - 6mm Reduction Sleeve
820080	20mm - 8mm Reduction Sleeve
820100	20mm - 10mm Reduction Sleeve
820120	20mm - 12mm Reduction Sleeve
820140	20mm - 14mm Reduction Sleeve
820160	20mm - 16mm Reduction Sleeve
520108	20mm - 1/8" Reduction Sleeve
520316	20mm - 3/16" Reduction Sleeve
520104	20mm - 1/4" Reduction Sleeve
520516	20mm - 5/16" Reduction Sleeve
520308	20mm - 3/8" Reduction Sleeve
520102	20mm - 1/2" Reduction Sleeve
520508	20mm - 5/8" Reduction Sleeve

\*Blue shade = **H-LOCKED**

### 1-1/4" O.D. Reduction Sleeves

Part No.	Description, O.D. - I.D.
632108	1-1/4" - 1/8" Reduction Sleeve
632316	1-1/4" - 3/16" Reduction Sleeve
632104	1-1/4" - 1/4" Reduction Sleeve
632516	1-1/4" - 5/16" Reduction Sleeve
632308	1-1/4" - 3/8" Reduction Sleeve
632102	1-1/4" - 1/2" Reduction Sleeve
632508	1-1/4" - 5/8" Reduction Sleeve
632304	1-1/4" - 3/4" Reduction Sleeve
632100	1-1/4" - 1" Reduction Sleeve
632787	1-1/4" - 20mm Reduction Sleeve
632984	1-1/4" - 25mm Reduction Sleeve

\*Blue shade = **H-LOCKED**

### 32mm O.D. Reduction Sleeves

Part No.	Description, O.D. - I.D.
832060	32mm - 6mm Reduction Sleeve
832080	32mm - 8mm Reduction Sleeve
832100	32mm - 10mm Reduction Sleeve
832120	32mm - 12mm Reduction Sleeve
832140	32mm - 14mm Reduction Sleeve
832160	32mm - 16mm Reduction Sleeve
832180	32mm - 18mm Reductino Sleeve
832200	32mm - 20mm Reduction Sleeve
832250	32mm - 25mm Reduction Sleeve

\*Blue shade = **H-LOCKED**

### 3/4" O.D. Reduction Sleeves

Part No.	Description, O.D. - I.D.
625108	3/4" - 1/8" Reduction Sleeve
625316	3/4" - 3/16" Reduction Sleeve
625104	3/4" - 1/4" Reduction Sleeve
625516	3/4" - 5/16" Reduction Sleeve
625308	3/4" - 3/8" Reduction Sleeve
625716	3/4" - 7/16" Reduction Sleeve
625102	3/4" - 1/2" Reduction Sleeve
625508	3/4" - 5/8" Reduction Sleeve
625003	3/4" - 3mm Reduction Sleeve
625004	3/4" - 4mm Reduction Sleeve
625005	3/4" - 5mm Reduction Sleeve
625006	3/4" - 6mm Reduction Sleeve
625008	3/4" - 8mm Reduction Sleeve
625010	3/4" - 10mm Reduction Sleeve
625012	3/4" - 12mm Reduction Sleeve
625014	3/4" - 14mm Reduction Sleeve
625016	3/4" - 16mm Reduction Sleeve

\*Blue shade = **H-LOCKED**





# POWER MILLING CHUCKS & OTHER HOLDER TYPES

EXTEND TOOL LIFE AND IMPROVE SURFACE FINISH.



## POWER MILLING CHUCKS



- Grips shank up to 5X tighter than ER40 holders
- Nut seats against the flange when properly tightened (prevents overtightening)
- CoolBLAST coolant-thru standard on all milling chucks

### TORQUE TESTED TO 5X TIGHTER GRIP

Techniks Milling Chucks provide up to 5x tighter grip on the shank than other manufacturer's ER 40 holders with an uncoated nut.

Toolholder Type	Shank Spins At:
Other ER 40 holders	100 ft/lbs
Techniks 3/4" milling chucks	350 ft/lbs
Techniks 1" milling chucks	425 ft/lbs
Techniks 1-1/4" milling chucks	500 ft/lbs

### SPECIAL SLOTTED DESIGN

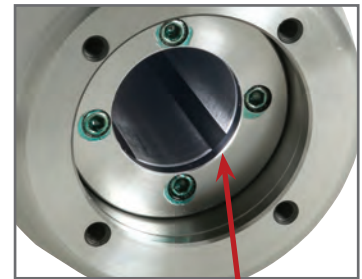

Special slotted design of bore I.D. increases holding power and reduces vibration.

## OTHER HOLDER TYPES

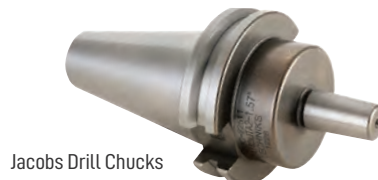



# CAT 40/50 MILLING CHUCKS



3/4" chuck shown above. Use milling chuck sleeves to change tool shank size.



Each Techniks High-Performance Milling Chuck is inspected, tested, and certified for quality, accuracy, and holding power. A full lab report is included with each holder.

## FEATURES

- Grips shank up to 5x tighter than ER 40 collet chucks
- Nut seats against the flange when properly tightened (prevents overtightening)
- CoolBLAST coolant-thru standard on all milling chucks

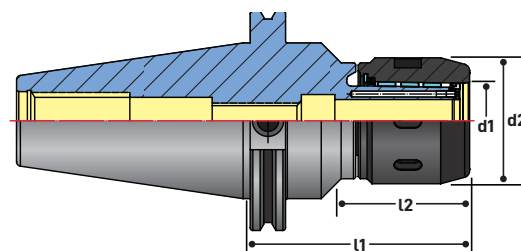

## CAT40 MILLING CHUCKS

Part No.	Description	l1	l2	d1	d2
23202G	CAT40 x MLD 3/4" - 4"	4"	2.38"	3/4"	2.24"
23203G	CAT40 x MLD 3/4" - 6"	6"	2.38"	3/4"	2.24"
23204G	CAT40 x MLD 1" - 4"	4"	2.23"	1"	2.36"
23210G	CAT40 x MLD 1-1/4" - 4.2"	4.2"	2.38"	1-1/4"	2.8"

## CAT50 MILLING CHUCKS

Part No.	Description	l1	l2	d1	d2
23214G	CAT50 x MLD 3/4" - 4"	4"	2.38"	3/4"	2.24"
23218G	CAT50 x MLD 1" - 4"	4"	2.23"	1"	2.36"
23222G	CAT50 x MLD 1-1/4" - 4.13"	4.13"	2.38"	1-1/4"	2.8"
23224G	CAT50 x MLD 1-1/4" - 6"	6"	2.38"	1-1/4"	2.8"

### SPECIAL SLOTTED DESIGN

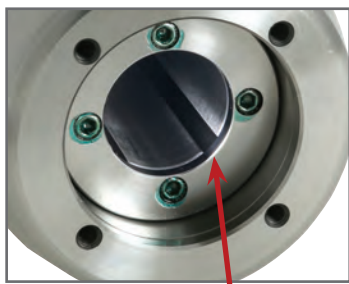

Special slotted design of bore I.D. increases holding power and reduces vibration.

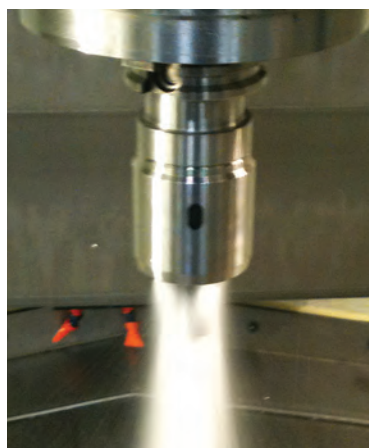

### MACHINED BEARING CAGE

High-precision, individually matched needle bearings symmetrically placed for smooth and reliable operation.

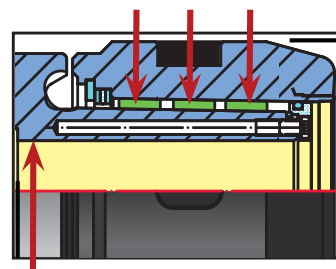

Machined bearing cage ensures accuracy and gripping force.



pg. 229



pg. 236



pg. 238

# CAT 40/50 MILLING CHUCKS - DUALDRIVE

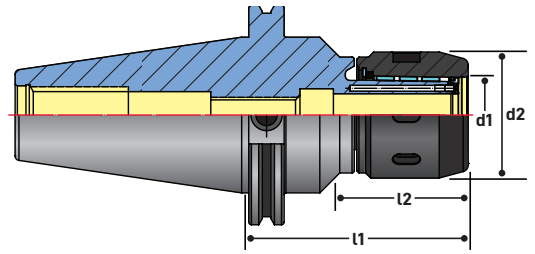

## CAT40 MILLING CHUCKS **DUALDRIVE**

Part No.	Description	l1	l2	d1	d2
43.463G.64.400	SCAT40 x MLD 3/4" - 4" DualDRIVE	4"	2.38"	3/4"	2.24"
43.463G.68.400	SCAT40 x MLD 1" - 4" DualDRIVE	4"	2.23"	1"	2.36"
43.463G.72.420	SCAT40 x MLD 1-1/4" - 4.2" DualDRIVE	4.2"	2.38"	1-1/4"	2.8"

## CAT50 MILLING CHUCKS **DUALDRIVE**

Part No.	Description	l1	l2	d1	d2
44.463G.64.400	SCAT50 x MLD 3/4" - 4" DualDRIVE	4"	2.38"	3/4"	2.24"
44.463G.64.600	SCAT 50 x MLD 3/4" - 6" DualDRIVE	6"	2.38"	3/4"	2.24"
44.463G.64.600	SCAT 50 x MLD 3/4" - 6" DualDRIVE	6"	2.38"	3/4"	2.24"
44.463G.64.800	SCAT 50 x MLD 3/4" - 8" DualDRIVE	8"	2.38"	3/4"	2.24"
44.463G.68.400	SCAT50 x MLD 1" - 4" DualDrive	4"	2.23"	1"	2.36"
44.463G.72.413	SCAT50 x MLD 1-1/4" - 4.13" DualDRIVE	4.13"	2.38"	1-1/4"	2.8"
44.463G.72.600	SCAT 50 x MLD 1-1/4" - 6" DualDRIVE	6"	2.38"	1-1/4"	2.8"
44.463G.72.800	SCAT 50 x MLD 1-1/4" - 8" DualDRIVE	8"	2.38"	1-1/4"	2.8"

## MILLING CHUCK COOLANT CAPS

Use coolant cap and Black Gold ring for coolant-thru tools.

Use coolant cap with Black Gold ER25 or ER40 coolant rings.

Select the coolant ring to fit your shank size. See page 64.



Snap ring into cap.  
Screw cap to end of milling chuck.



Coolant-thru tool installed



Part No.	Description	Ring	Shank Size
19496G	3/4" coolant cap	ER25	1/8" - 5/8"
19496G-2	3/4" coolant cap - on size	NA	3/4"
19497G	1" coolant cap	ER32	1/8" - 3/4"
19497G-2	1" coolant cap - on size	NA	1"
19498G	1-1/4" coolant cap	ER40	1/8" - 1"
19498G-2	1-1/4" coolant cap - on size	NA	1-1/4"



## FEATURES

- Techniks Certified for dual-contact spindles
- Grips shank up to 5x tighter than ER 40 collet chucks
- Nut seats against the flange when properly tightened (prevents overtightening)

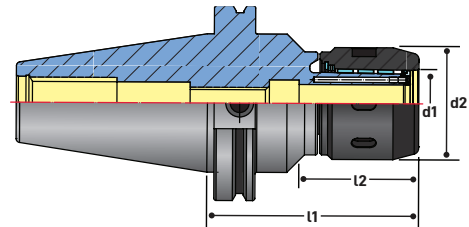

Each Techniks High-Performance Milling Chuck is inspected, tested, and certified for quality, accuracy, and holding power. A full lab report is included with each holder.

## BT40 MILLING CHUCKS

Part No.	Description	l1	l2	d1	d2
15994G	BT40 X MLD 3/4" - 3.15	3.15"	1.97"	3/4"	2.22"
15995G	BT40 X MLD 1" - 3.15	3.15"	2.07"	1"	2.36"
15996G	BT40 x MLD 1-1/4" - 4"	4"	2.62"	1-1/4"	2.8"

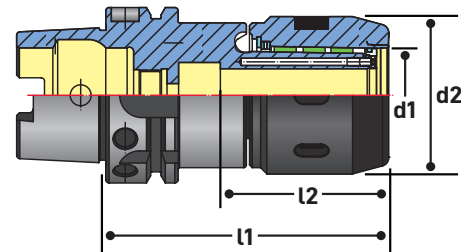

## HSK63A / HSK100A MILLING CHUCKS

Part No.	Description	l1	l2	d1	d2
33232G	HSK63A X MLD 3/4" - 4"	4"	2.01"	3/4"	2.22"
33236G	HSK63A x MLD 1-1/4" - 4.72"	4.72"	2.65"	1-1/4"	2.8"
33252G	HSK100A X MLD 3/4" - 4.72"	4.72"	2.01"	3/4"	2.22"
33256G	HSK100A x MLD 1-1/4" - 4.72"	4.72"	2.65"	1-1/4"	2.79"



pg. 229



pg. 236



pg. 238

# REDUCTION SLEEVES FOR MILLING CHUCKS

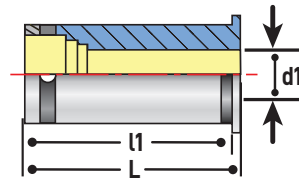

## FEATURES

- T.I.R. only 0.0001"
- For inch and metric shanks
- Precision ground for maximum accuracy

Use sleeves to change tool shank sizes just like you would collets.

## 3/4" O.D. REDUCTION SLEEVES

Part No.	Description	d1	l1	L
84126-1/8	3/4" O.D. x 1/8" I.D.	1/8"	1.93"	2.09"
84126-3/16	3/4" O.D. x 3/16" I.D.	3/16"	1.93"	2.09"
84126-1/4	3/4" O.D. x 1/4" I.D.	1/4"	1.93"	2.09"
84126-17/64	3/4" O.D. x 17/64" I.D.	17/64"	1.93"	2.09"
84126-9/32	3/4" O.D. x 9/32" I.D.	9/32"	1.93"	2.09"
84126-5/16	3/4" O.D. x 5/16" I.D.	5/16"	1.93"	2.09"
84126-11/32	3/4" O.D. x 11/32" I.D.	11/32"	1.93"	2.09"
84126-3/8	3/4" O.D. x 3/8" I.D.	3/8"	1.93"	2.09"
84126-25/64	3/4" O.D. x 25/64" I.D.	25/64"	1.93"	2.09"
84126-7/16	3/4" O.D. x 7/16" I.D.	7/16"	1.93"	2.09"
84126-15/32	3/4" O.D. x 15/32" I.D.	15/32"	1.93"	2.09"
84126-1/2	3/4" O.D. x 1/2" I.D.	1/2"	1.93"	2.09"
84126-9/16	3/4" O.D. x 9/16" I.D.	9/16"	1.93"	2.09"
84126-37/64	3/4" O.D. x 37/64" I.D.	37/64"	1.93"	2.09"
84126-5/8	3/4" O.D. x 5/8" I.D.	5/8"	1.93"	2.09"
84126-06	3/4" O.D. x 6mm I.D.	6mm	1.93"	2.09"
84126-08	3/4" O.D. x 8mm I.D.	8mm	1.93"	2.09"
84126-10	3/4" O.D. x 10mm I.D.	10mm	1.93"	2.09"
84126-12	3/4" O.D. x 12mm I.D.	12mm	1.93"	2.09"
84126-14	3/4" O.D. x 14mm I.D.	14mm	1.93"	2.09"
84126-16	3/4" O.D. x 16mm I.D.	16mm	1.93"	2.09"

## 1" O.D. REDUCTION SLEEVES

Part No.	Description	d1	l1	L
84128-1/8	1" O.D. x 1/8" I.D.	1/8"	2.16"	2.36"
84128-3/16	1" O.D. x 3/16" I.D.	3/16"	2.16"	2.36"
84128-1/4	1" O.D. x 1/4" I.D.	1/4"	2.16"	2.36"
84128-5/16	1" O.D. x 5/16" I.D.	5/16"	2.16"	2.36"
84128-3/8"	1" O.D. x 3/8" I.D.	3/8"	2.16"	2.36"
84128-7/16	1" O.D. x 7/16" I.D.	7/16"	2.16"	2.36"
84128-1/2	1" O.D. x 1/2" I.D.	1/2"	2.16"	2.36"
84128-9/16	1" O.D. x 9/16" I.D.	9/16"	2.16"	2.36"
84128-5/8	1" O.D. x 5/8" I.D.	5/8"	2.16"	2.36"
84128-3/4	1" O.D. x 3/4" I.D.	3/4"	2.16"	2.36"
84128-7/8	1" O.D. x 3/4" I.D.	7/8"	2.16"	2.36"

## 1-1/4" O.D. REDUCTION SLEEVES

Part No.	Description	d1	l1	L
84127-1/8	1-1/4" O.D. x 1/8" I.D.	1/8"	2.56"	2.75"
84127-3/16	1-1/4" O.D. x 3/16" I.D.	3/16"	2.56"	2.75"
84127-1/4	1-1/4" O.D. x 1/4" I.D.	1/4"	2.56"	2.75"
84127-5/16	1-1/4" O.D. x 5/16" I.D.	5/16"	2.56"	2.75"
84127-3/8	1-1/4" O.D. x 3/8" I.D.	3/8"	2.56"	2.75"
84127-7/16	1-1/4" O.D. x 7/16" I.D.	7/16"	2.56"	2.75"
84127-1/2	1-1/4" O.D. x 1/2" I.D.	1/2"	2.56"	2.75"
84127-33/64	1-1/4" O.D. x 33/64" I.D.	33/64"	2.56"	2.75"
84127-17/32	1-1/4" O.D. x 17/32" I.D.	17/32"	2.56"	2.75"
84127-9/16	1-1/4" O.D. x 9/16" I.D.	9/16"	2.56"	2.75"
84127-5/8	1-1/4" O.D. x 5/8" I.D.	5/8"	2.56"	2.75"
84127-41/64	1-1/4" O.D. x 41/64" I.D.	41/64"	2.56"	2.75"
84127-11/16	1-1/4" O.D. x 11/16" I.D.	11/16"	2.56"	2.75"
84127-23/32	1-1/4" O.D. x 23/32" I.D.	23/32"	2.56"	2.75"
84127-3/4	1-1/4" O.D. x 3/4" I.D.	3/4"	2.56"	2.75"
84127-49/64	1-1/4" O.D. x 49/64" I.D.	49/64"	2.56"	2.75"
84127-25/32	1-1/4" O.D. x 25/32" I.D.	25/32"	2.56"	2.75"
84127-13/16	1-1/4" O.D. x 13/16" I.D.	13/16"	2.56"	2.75"
84127-7/8	1-1/4" O.D. x 7/8" I.D.	7/8"	2.56"	2.75"
84127-1	1-1/4" O.D. x 1.0" I.D.	1.0"	2.56"	2.75"
84127-08	1-1/4" O.D. x 8mm I.D.	8mm	2.56"	2.75"
84127-10	1-1/4" O.D. x 10mm I.D.	10mm	2.56"	2.75"
84127-12	1-1/4" O.D. x 12mm I.D.	12mm	2.56"	2.75"
84127-13	1-1/4" O.D. x 13mm I.D.	13mm	2.56"	2.75"
84127-14	1-1/4" O.D. x 14mm I.D.	14mm	2.56"	2.75"
84127-16	1-1/4" O.D. x 16mm I.D.	16mm	2.56"	2.75"
84127-18	1-1/4" O.D. x 18mm I.D.	18mm	2.56"	2.75"
84127-20	1-1/4" O.D. x 20mm I.D.	20mm	2.56"	2.75"
84127-23	1-1/4" O.D. x 23mm I.D.	23mm	2.56"	2.75"
84127-26	1-1/4" O.D. x 26mm I.D.	26mm	2.56"	2.75"
84127-25	1-1/4" O.D. x 25mm I.D.	25mm	2.56"	2.75"





## MACHINABLE BLANKS

Techniks machinable blanks provide a quality platform for creating your own custom tools. They are made from high-grade tool steel for best performance.

Material analysis shows that the hardness at the spindle end is HRC 58° for long life and reduced spindle wear. The hardness on the machining end is HRC 25°-28° and remains stable from the surface all the way to the core.

## CAT AND HSK MACHINABLE BLANKS

Part No.	Description	d1	l1
31.001.92.600	CAT40 x 2.5" -6"	2.5"	6"
31.001.92.100	CAT40 x 2.5" -10"	2.5"	10"
32.001.98.800	CAT50 x 3" -8"	3"	8"
32.001.A2.110	CAT50 x 3.5" -11"	3.5"	11"
73.001.98.600	HSK63A x 3" -6"	3"	6"
73.001.A2.100	HSK63A x 3.5" -10"	3.5"	10"
75.001.99.100	HSK100A x 4" -10"	4"	10"

## TECHNIKS CERTIFIED FEATURES

- Taper ground to AT3 accuracy or better
- Each blank is individually tested, measured and certified for accuracy

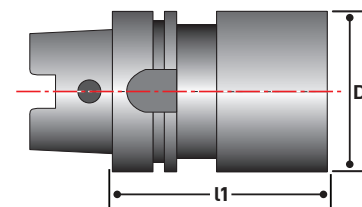
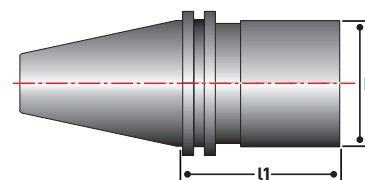
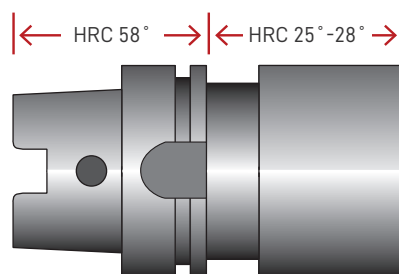



pg. 229



pg. 236



pg. 238

# MORSE TAPER HOLDERS



CAT40 Morse Taper



BT40 Morse Taper

## FEATURES

- Taper ground to AT3 accuracy or better
- .0002" runout from taper to tool pocket
- Each holder lab certified for accuracy

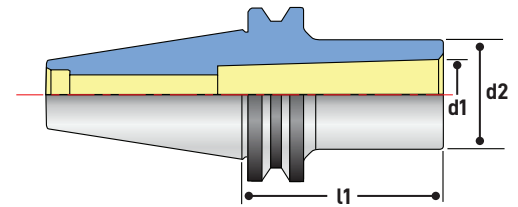

## CAT MORSE TAPER HOLDERS

Part No.	Taper	Size	l1	d1	d2
22611	CAT40 x MT#1 - 1.75"	MT#1	1.75"	.47"	.98"
22613	CAT40 x MT#2 - 2"	MT#2	2"	.7"	1.26"
22615	CAT40 x MT#3 - 2.75"	MT#3	2.75"	.94"	1.57"
22617	CAT40 x MT#4 - 3.75"	MT#4	3.75"	1.23"	1.89"
22623	CAT50 x MT#2 - 2"	MT#2	2"	.7"	1.26"
22625	CAT50 x MT#3 - 2.56"	MT#3	2.56"	.94"	1.57"
22627	CAT50 x MT#4 - 3.75"	MT#4	3.75"	1.23"	1.89"
22629	CAT50 x MT#5 - 4.13"	MT#5	4.13"	1.75"	2.48"

## BT MORSE TAPER HOLDERS

Part No.	Taper	Size	l1	d1	d2
17001	BT30 x MT#1 - 1.75"	MT#1	1.77"	.47"	.98"
17006	BT30 x MT#2 - 1.75"	MT#2	2.36"	.7"	1.26"
17010	BT30 x MT#3 - 1.75"	MT#3	3.14"	.94"	1.57"
17011	BT40 x MT#1 - 1.75"	MT#1	1.77"	.47"	.98"
17014	BT40 x MT#2 - 1.75"	MT#2	1.96"	.7"	1.26"
17018	BT40 x MT#3 - 1.75"	MT#3	2.75"	.94"	1.57"
17023	BT40 x MT#4 - 1.75"	MT#4	3.75"	1.23"	1.89"
17036	BT50 x MT#2 - 2.36"	MT#2	2.36"	.7"	1.26"
17039	BT50 x MT#2 - 5.31"	MT#2	5.31"	.7"	1.26"
17042	BT50 x MT#3 - 2.56"	MT#3	2.56"	.94"	1.57"
17046	BT50 x MT#3 - 5.9"	MT#3	5.9"	.94"	1.57"
17048	BT50 x MT#4 - 3.74"	MT#4	3.74"	1.23"	1.89"
17051	BT50 x MT#4 - 7.08"	MT#4	7.08"	1.23"	1.89"
17053	BT50 x MT#5 - 4.13"	MT#5	4.13"	1.75"	2.48"





# SIMIS ER COLLET CHUCKS

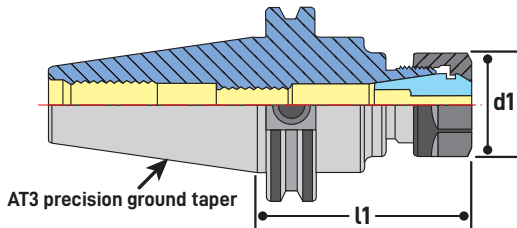

## SIMIS ECONOMY COLLET CHUCKS VS. TECHNIKS

Feature	SIMIS	Techniks Certified
Lab Certified for Accuracy & Balance	NO	YES
Balance Specification	18,000 RPMs	25,000 RPMs
Collet Nut	Standard, uncoated	PowerCOAT
DIN B Coolant Available	NO	YES
Available Sizes	most common	wide selection

## CAT40 SIMIS COLLET CHUCKS

Part No.	Description	l1	d1	Max. Shank	Stop Screw	Wrench	Nut
CAT40ER11-3	CAT40 x ER11 - 3"	3"	.75"	.275"	16081	04608	11111
CAT40ER11-4	CAT40 x ER11 - 4"	4"	.75"	.275"	16081	04608	11111
CAT40ER11-6	CAT40 x ER11 - 6"	6"	.75"	.275"	16081	04608	11111
CAT40ER16-2.76	CAT40 x ER16 - 2.76"	2.76"	1.08"	.406"	16083	04609	11116
CAT40ER16-4	CAT40 x ER16 - 4"	4"	1.08"	.406"	16083	04609	11116
CAT40ER20-2.76	CAT40 x ER20 - 2.76"	2.76"	1.34"	.512"	16087	04610	11120
CAT40ER20-4	CAT40 x ER20 - 4"	4"	1.34"	.512"	16087	04610	11120
CAT40ER20-6	CAT40 x ER20 - 6"	6"	1.34"	.512"	16087	04610	11120
CAT40ER25-2.76	CAT40 x ER25 - 2.76"	2.76"	1.65"	.63"	16089	04615	11125
CAT40ER25-4	CAT40 x ER25 - 4"	4"	1.65"	.63"	16089	04615	11125
CAT40ER32-2.76	CAT40 x ER32 - 2.76"	2.76"	1.97"	.788"	16089	04616	11132
CAT40ER32-4	CAT40 x ER32 - 4"	4"	1.97"	.788"	16089	04616	11132
CAT40ER40-3.15	CAT40 x ER40 - 3.15"	3.15"	2.48"	1.023"	16091	04617	11140

## CAT50 SIMIS COLLET CHUCKS

Part No.	Description	l1	d1	Max. Shank	Stop Screw	Wrench	Nut
CAT50ER16-4	CAT50 x ER16 - 4"	4"	1.08"	.406"	16083	04609	11116
CAT50ER16-6	CAT50 x ER16 - 6"	6"	1.08"	.406"	16083	04609	11116
CAT50ER20-4	CAT50 x ER20 - 4"	4"	1.34"	.512"	16087	04610	11120
CAT50ER20-6	CAT50 x ER20 - 6"	6"	1.34"	.512"	16087	04610	11120
CAT50ER32-4	CAT50 x ER32 - 4"	4"	1.97"	.788"	16089	04616	11132
CAT50ER32-6	CAT50 x ER32 - 6"	6"	1.97"	.788"	16089	04616	11132
CAT50ER40-4	CAT50 x ER40 - 4"	4"	2.48"	1.023"	16091	04617	11140



pg. 229



pg. 236



pg. 238

# SIMIS END MILL HOLDERS

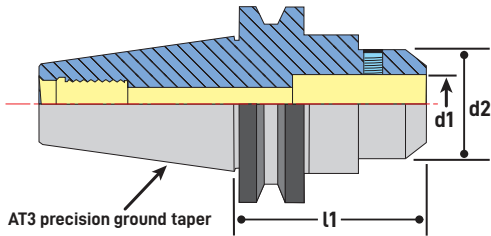

## SIMIS ECONOMY END MILL HOLDERS VS. TECHNIKS

	SIMIS	Techniks Certified
Lab Certified for Accuracy & Balance	NO	YES
Balance Specification	8,000 RPMs	15,000 RPMs
End Mill Bore Tolerance	H7	H5
DIN B Coolant Available	NO	YES
Available Sizes	most common	wide selection

## CAT40 SIMIS END MILL HOLDERS

Part No.	Description	l1	d1	d2
CAT40SLN1/8	CAT40 x SLN 1/8" - 2.37"	2.37"	1/8"	.69"
CAT40SLN3/16	CAT40 x SLN 3/16" - 2.5"	2.5"	3/16"	.69"
CAT40SLN1/4-1.75	CAT40 x SLN 1/4" - 1.75"	1.75"	1/4"	.78"
CAT40SLN1/4	CAT40 x SLN 1/4" - 3"	3"	1/4"	.78"
CAT40SLN3/8-1.75	CAT40 x SLN 3/8" - 1.75"	1.75"	3/8"	1"
CAT40SLN3/8	CAT40 x SLN 3/8" - 3"	3"	3/8"	1"
CAT40SLN1/2-1.75	CAT40 x SLN 1/2" - 1.75"	1.75"	1/2"	1.25"
CAT40SLN1/2	CAT40 x SLN 1/2" - 3"	3"	1/2"	1.25"
CAT40SLN5/8	CAT40 x SLN 5/8" - 3"	3"	5/8"	1.5"
CAT40SLN3/4-1.75	CAT40 x SLN 3/4" - 1.75"	1.75"	3/4"	1.75"
CAT40SLN3/4	CAT40 x SLN 3/4" - 3.5"	3.5"	3/4"	1.75"
CAT40SLN1-1.75	CAT40 x SLN 1" - 1.75"	1.75"	1"	2"
CAT40SLN1	CAT40 x SLN 1" - 4"	4"	1"	2"
CAT40SLN1-1/4	CAT40 x SLN 1-1/4" - 2"	2"	1-1/4"	2.5"

## CAT50 SIMIS END MILL HOLDERS

Part No.	Description	l1	d1	d2
CAT50SLN1/4	CAT50 x SLN 1/4" - 4"	4"	1/4"	.78"
CAT50SLN3/8	CAT50 x SLN 3/8" - 4"	4"	3/8"	1"
CAT50SLN1/2	CAT50 x SLN 1/2" - 4"	4"	1/2"	1.25"
CAT50SLN5/8	CAT50 x SLN 5/8" - 4"	4"	5/8"	1.5"
CAT50SLN3/4	CAT50 x SLN 3/4" - 4"	4"	3/4"	1.75"
CAT50SLN1	CAT50 x SLN 1" - 4"	4"	1"	2"
CAT50SLN1-1/4	CAT50 x SLN 1-1/4" - 4.6"	4.6"	1-1/4"	2.5"



# HP3 / KEYLESS JACOBS DRILL CHUCKS



## FEATURES

- Capacity from 1/16" to 1/2"
- 4X greater holding power than standard drill chucks
- Balanced to 10,000 RPM

Our HP3 High-Precision Drill Chucks have the flexibility to hold a wide range of shank sizes and deliver superior performance too. Maximum runout (T.I.R.) is only .0008".

They also feature a one-piece design that provides greater rigidity and safety because the chuck cannot break free during operation.

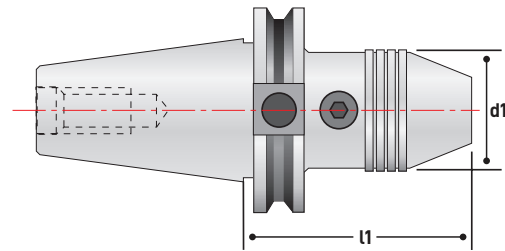

## HP3 PRECISION DRILL CHUCKS (ISO, BT, HSK)

Part No.	Description	d1	l1
24.05.046.005	CAT40 HP3 drill chuck 1/2"	50mm	103mm
17.05.046.005	CAT50 HP3 drill chuck 1/2"	50mm	87.5mm
64.05.046.051	ISO30 HP3 drill chuck 1/2"	50mm	103mm
67.05.046.001	BT30 HP3 drill chuck 1/2"	50mm	92.5mm
39.05.046.001	BT40 HP3 drill chuck 1/2"	50mm	95.5mm
93.05.046.003	HSK 63A HP3 drill chuck 1/2"	50mm	123.5mm
171.05.046.003	HSK63F HP3 drill chuck 1/2"	50mm	123.5mm



## FEATURES

- For milling machines & drilling machines
- All hardened parts for long life and safety
- Use with Jacobs Taper tool holders

## KEYLESS JACOBS TAPER DRILL CHUCKS

Part No.	Description	Length Closed	Outer Diameter	Range
82150	08S x JT1	76mm	38mm	0 - 5/16"
82153	13S x JT6	102mm	49mm	0 - 1/2"
82151-JT33	10S x JT33	92mm	43mm	0 - 3/8"
82153-JT33	13S x JT33	102mm	49mm	0 - 1/2"



pg. 229



pg. 236



pg. 238

# KEYLESS DRILL CHUCKS



## FEATURES

- 3 times more holding power than other drill chucks
- Holds non-standard shank sizes up to 1/2"
- Replaceable chuck is held by a drawbolt

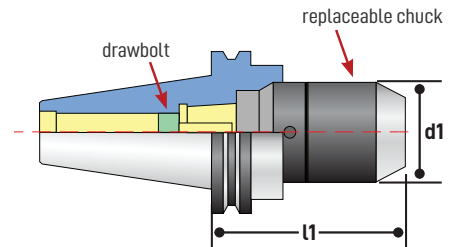

## CAT REPLACEABLE DRILL CHUCKS

Part No.	Description	l1	d1
22403	CAT40 SPU x 1/2" - 4"	101.6mm	50mm
22405	CAT50 SPU x 1/2" - 4"	101.6mm	50mm
82164	SPU drill chuck (replacement)		
82172	SPU drill chuck wrench (replacement)		

## BT REPLACEABLE DRILL CHUCKS

Part No.	Description	l1	d1
16456-W	BT30 x SPU 13mm - 110mm (no slots)	110mm	50mm
16456	BT30 x SPU 13mm - 110mm	110mm	50mm
16466	BT40 x SPU 13mm - 100mm	100mm	50mm
16476	BT50 x SPU 13mm - 100mm	100mm	50mm
82164	SPU drill chuck (replacement)		
82172	SPU drill chuck wrench (replacement)		

## HSK REPLACEABLE DRILL CHUCKS

Part No.	Description	l1	d1
34905	HSK 63A x SPU 13mm - 150mm	150mm	50mm
34905-F	HSK 63F x SPU 13mm - 150mm	150mm	50mm
82164	SPU drill chuck (replacement)		
82172	SPU drill chuck wrench (replacement)		

# JACOBS TAPER DRILL CHUCKS

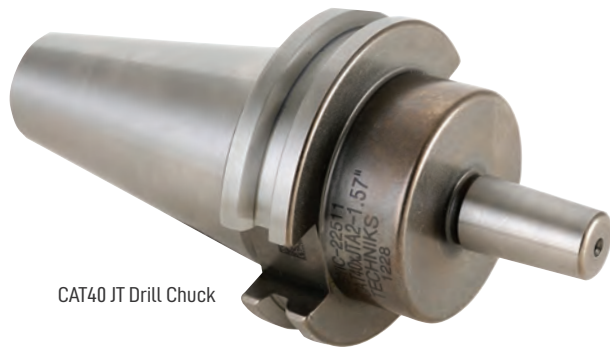

CAT40 JT Drill Chuck



BT50 JT Drill Chuck

## FEATURES

- Better T.I.R. and rigidity than standard drill chucks
- Taper ground to AT3 accuracy
- Use with keyless Jacobs Taper Drill Chucks

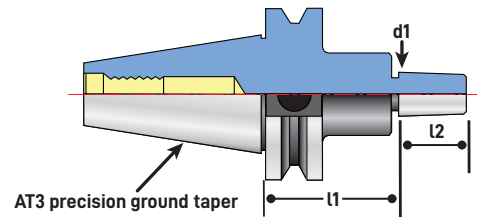

## CAT JACOBS TAPER DRILL CHUCKS

Part No.	Description	l1	l2	d1
22511	CAT40 x JT2 - 1.57"	1.57"	.875"	.559"
22512	CAT40 x JT3 - 1.57"	1.57"	1.2"	.811"
22513	CAT40 x JT6 - 1.57"	1.57"	.945"	.676"
22515	CAT40 x JT33 - 1.57"	1.57"	.945"	.624"
22521	CAT50 x JT2 - 1.57"	1.57"	.875"	.559"
22527	CAT50 x JT3 - 1.57"	1.57"	1.2"	.811"
22529	CAT50 x JT4 - 1.57"	1.57"	1.656"	1.124"
22531	CAT50 x JT5 - 1.57"	1.57"	1.875"	1.413"
22523	CAT50 x JT6 - 1.57"	1.57"	.945"	.676"
22525	CAT50 x JT33 - 1.57"	1.57"	.945"	.624"

## BT JACOBS TAPER DRILL CHUCKS

Part No.	Description	l1	l2	d1
16502	BT30 x JT2 - 45mm	45mm	20mm	14.199mm
16504	BT30 x JT33 - 45mm	45mm	24mm	15.850mm
16506	BT30 x JT6 - 45mm	45mm	24mm	17.170mm
16522	BT40 x JT2 - 45mm	45mm	20mm	14.199mm
16523	BT40 x JT33 - 45mm	45mm	24mm	15.850mm
16524	BT40 x JT6 - 45mm	45mm	24mm	17.170mm
16542	BT50 x JT2 - 45mm	45mm	20mm	14.199mm
16543	BT50 x JT33 - 45mm	45mm	24mm	15.850mm
16544	BT50 x JT6 - 45mm	45mm	24mm	17.170mm



# TECHNIKS CERTIFIED FACE MILL ARBORS

## QUALITY & PERFORMANCE GUARANTEED

### H6 ARBOR TOLERANCE REDUCES CHATTER

**EXTENDED LENGTH FACE MILL ARBORS  
UP TO 14" GAUGE LENGTHS.**



Taper ground to AT3 tolerance or better.

**COOLANT THRU COMPATIBLE  
COOLBLAST ARBOR SCREWS FOR  
COOLANT UP TO 1,500 PSI**



CAT40-50, BT30-40-50, HSK63A-100A, PSC4-6

**DUALDRIVE FOR DUAL CONTACT SPINDLES  
ALSO COMPATIBLE WITH STANDARD SPINDLES**



Techniks Certified for dual contact

Standard  
DualDRIVE

Gap between spindle & tool holder can allow the holder to deflect under heavy side loads.

DualDRIVE eliminates the gap, improving rigidity & accuracy.





# CAT40 FACE MILL ARBORS



pg. 152



pg. 229



pg. 236



pg. 238



Techniks Certified for accuracy and balance. Each holder comes with a complete lab report. Taper ground to AT3 tolerance or better.

## FEATURES

- Compatible with all face mills
- H6 arbor tolerance for less chatter
- Taper ground to AT3 tolerance or better

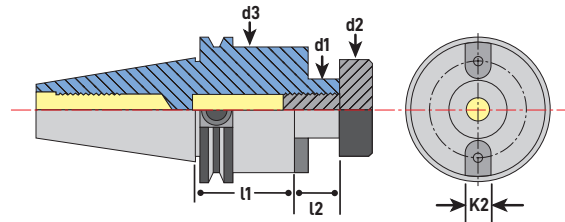

## CAT40 FACE MILL ARBORS

Part No.	Description	l1	l2	d1	d2	d3	K2	Screw	Key
22709	CAT40 x FMA 1/2" - 1.37"	1.37"	.55"	1/2"	.66"	1.45"	.25"	WF0.5	FMAKEY-1/2
22709-4	CAT40 x FMA 1/2" - 4"	4"	.55"	1/2"	.66"	1.45"	.25"	WF0.5	FMAKEY-1/2
22711	CAT40 x FMA 3/4" - 1.37"	1.37"	.69"	3/4"	.88"	1.69"	.31"	WF0.75-1.5	FMAKEY-3/4
22711-2.5	CAT 40 x FMA 3/4" - 2.5"	2.5"	.69"	3/4"	.88"	1.69"	.31"	WF0.75-1.5	FMAKEY-3/4
22711-4	CAT40 x FMA 3/4" - 4"	4"	.69"	3/4"	.88"	1.69"	.31"	WF0.75-1.5	FMAKEY-3/4
22711-6	CAT40 x FMA 3/4" - 6"	6"	.69"	3/4"	.88"	1.69"	.31"	WF0.75-1.5	FMAKEY-3/4
22711-8	CAT40 x FMA 3/4" - 8"	8"	.69"	3/4"	.88"	1.69"	.31"	WF0.75-1.5	FMAKEY-3/4
22713	CAT40 x FMA 1" - 2.06"	2.06"	.69"	1"	1.19"	2.2"	.38"	WF1-1.75	FMAKEY-1
22713-4	CAT40 x FMA 1" - 4"	4"	.69"	1"	1.19"	2.2"	.38"	WF1-1.75	FMAKEY-1
22713-6	CAT40 x FMA 1" - 6"	6"	.69"	1"	1.19"	2.2"	.38"	WF1-1.75	FMAKEY-1
22713-8	CAT40 x FMA 1" - 6"	8"	.69"	1"	1.19"	2.2"	.38"	WF1-1.75	FMAKEY-1
22715	CAT40 x FMA 1-1/4" - 2.21"	2.21"	.69"	1-1/4"	1.5"	2.75"	.5"	WF1.25-1.75	FMAKEY-1-1/4
22715-4	CAT40 x FMA 1-1/4" - 4"	4"	.69"	1-1/4"	1.5"	2.75"	.5"	WF1.25-1.75	FMAKEY-1-1/4
22715-6	CAT40 x FMA 1-1/4" - 6"	6"	.69"	1-1/4"	1.5"	3."	.5"	WF1.25-1.75	FMAKEY-1-1/4
22715-8	CAT40 x FMA 1-1/4" - 8"	8"	.69"	1-1/4"	1.5"	3."	.5"	WF1.25-1.75	FMAKEY-1-1/4
22717	CAT40 x FMA 1-1/2" - 2.21"	2.21"	.94"	1-1/2"	1.88"	3.8"	.63"	WF1.5-1.75	FMAKEY-1-1/2
22717-4	CAT40 x FMA 1-1/2" - 4"	4"	.94"	1-1/2"	1.88"	3.8"	.63"	WF1.5-1.75	FMAKEY-1-1/2

All Techniks Face Mill Arbors come with the solid arbor screw and keys listed.



**COOLANT THRU COMPATIBLE  
COOLBLAST ARBOR SCREWS  
PROVIDE EASY-FLOW CHANNELS  
FOR COOLANT UP TO 1,500 PSI**

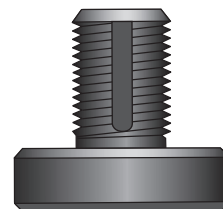



pg. 152



pg. 229



pg. 236



pg. 238

# CAT40 FACE MILL ARBORS - DUALDRIVE

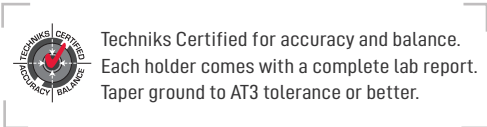

Techniks Certified for accuracy and balance. Each holder comes with a complete lab report. Taper ground to AT3 tolerance or better.

## FEATURES

- Techniks Certified for dual-contact spindles
- Superior rigidity and reduced vibration
- Improved performance at high metal removal rates or when machining at extended length

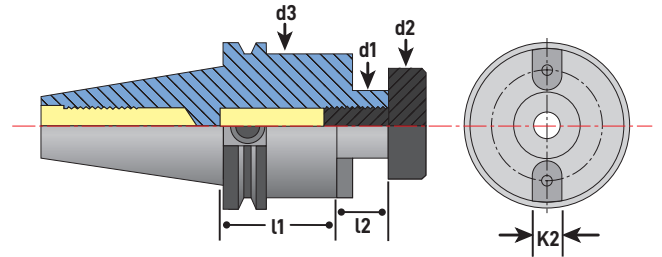

## CAT40 FACE MILL ARBORS **DUALDRIVE**

Part No.	Description	l1	l2	d1	d2	d3	K2	Screw	Key
43.151.64.137	CAT40 x FMA 3/4" - 1.37" DualDRIVE	1.37"	.69"	3/4"	.88"	1.69"	.31"	WF0.75-1.5	FMAKEY-3/4
43.151.64.200	SCAT 40 x FMA 3/4" - 2" DualDRIVE	2"	.69"	3/4"	.88"	1.69"	.31"	WF0.75-1.5	FMAKEY-3/4
43.151.64.400	CAT40 x FMA 3/4" - 4" DualDRIVE	4"	.69"	3/4"	.88"	1.69"	.31"	WF0.75-1.5	FMAKEY-3/4
43.151.64.500	SCAT 40 x FMA 3/4" - 5" DualDRIVE	5"	.69"	3/4"	.88"	1.69"	.31"	WF0.75-1.5	FMAKEY-3/4
43.151.64.600	CAT40 x FMA 3/4" - 6" DualDRIVE	6"	.69"	3/4"	.88"	1.69"	.31"	WF0.75-1.5	FMAKEY-3/4
43.151.68.206	CAT40 x FMA 1" - 2.06" DualDRIVE	2.06"	.69"	1"	1.19"	2.2"	.38"	WF1-1.75	FMAKEY-1
43.151.68.400	CAT40 x FMA 1" - 4" DualDRIVE	4"	.69"	1"	1.19"	2.2"	.38"	WF1-1.75	FMAKEY-1
43.151.68.600	CAT40 x FMA 1" - 6" DualDRIVE	6"	.69"	1"	1.19"	2.2"	.38"	WF1-1.75	FMAKEY-1
43.151.72.221	CAT40 x FMA 1-1/4" - 2.21" DualDRIVE	2.21"	.69"	1-1/4"	1.5"	2.75"	.5"	WF1.25-1.75	FMAKEY-1-1/4
43.151.72.400	CAT40 x FMA 1-1/4" - 4" DualDRIVE	4"	.69"	1-1/4"	1.5"	2.75"	.5"	WF1.25-1.75	FMAKEY-1-1/4
43.151.72.600	CAT40 x FMA 1-1/4" - 6" DualDRIVE	6"	.69"	1-1/4"	1.5"	3"	.5"	WF1.25-1.75	FMAKEY-1-1/4
43.151.77.221	CAT40 x FMA 1-1/2" - 2.21" DualDRIVE	2.21"	.94"	1-1/2"	1.88"	3.8"	.63"	WF1.5-1.75	FMAKEY-1-1/2
43.151.77.400	CAT40 x FMA 1-1/2" - 4" DualDRIVE	4"	.94"	1-1/2"	1.88"	3.8"	.63"	WF1.5-1.75	FMAKEY-1-1/2
43.151.86.240	SCAT 40 x FMA 2" - 2.4" DualDRIVE	2.4"	.94"	2"	2.5"	4.88"	.75"	WF2	FMAKEY-2

All Techniks Face Mill Arbors come with the solid arbor screw and keys listed.

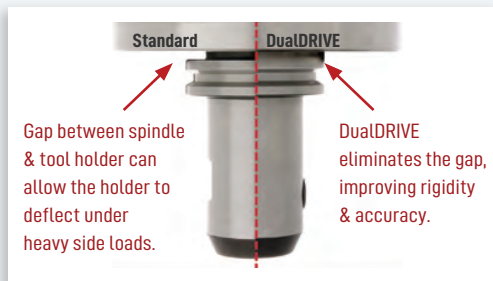

## DUAL-CONTACT SPINDLES

Dual-Contact is a spindle option offered by some machine tool builders where both the toolholder taper and the flange make contact with the spindle. The dual-contact provides increased rigidity and accuracy during heavy side loads.

# CAT50 FACE MILL ARBORS



pg. 152



pg. 229



pg. 236



pg. 238

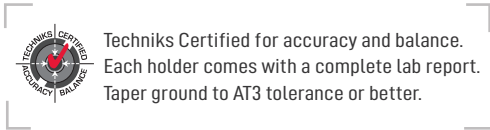

Techniks Certified for accuracy and balance. Each holder comes with a complete lab report. Taper ground to AT3 tolerance or better.

## FEATURES

- Compatible with all face mills
- H6 arbor tolerance for less chatter
- Taper ground to AT3 tolerance or better

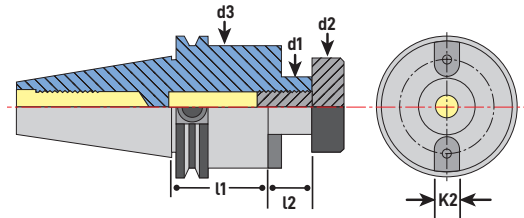

## CAT50 FACE MILL ARBORS

Part No.	Description	l1	l2	d1	d2	d3	K2	Screw	Key
22719	CAT50 x FMA 1/2" - 1.5"	1.5"	.055"	1/2"	.66"	1.45"	.25"	WF0.5	FMAKEY-1/2
22719-4	CAT 50 x FMA 3/4" - 2.5"	4"	.55"	3/4"	.66"	1.45"	.25"	WF0.5	FMAKEY-1/2
22721	CAT50 x FMA 3/4" - 1.5"	1.5"	.69"	3/4"	.88"	2.75"	.31"	WF0.75-1.5	FMAKEY-3/4
22721-3.5	CAT50 x FMA 3/4" - 3.5"	3.5"	.69"	3/4"	.88"	1.69"	.31"	WF0.75-1.5	FMAKEY-3/4
22721-5.5	CAT50 x FMA 3/4" - 5.5"	5.5"	.69"	3/4"	.88"	1.69"	.31"	WF0.75-1.5	FMAKEY-3/4
22721-8	CAT50 x FMA 3/4" - 8"	8"	.69"	3/4"	.88"	1.69"	.31"	WF0.75-1.5	FMAKEY-3/4
22721-10	CAT50 x FMA 3/4" - 10"	10"	.69"	3/4"	.88"	1.69"	.31"	WF0.75-1.5	FMAKEY-3/4
22721-12	CAT50 x FMA 3/4" - 12"	12"	.69"	3/4"	.88"	1.69"	.31"	WF0.75-1.5	FMAKEY-3/4
22721-14	CAT 50 x FMA 1" - 14"	14"	.69"	1"	1.19"	2.2"	.38"	WF0.75-1.5	FMAKEY-1/2
22723	CAT50 x FMA 1" - 2"	2"	.69"	1"	1.19"	2.2"	.38"	WF1-1.75	FMAKEY-1
22723-4	CAT50 x FMA 1" - 4"	4"	.69"	1"	1.19"	2.2"	.38"	WF1-1.75	FMAKEY-1
22723-6	CAT50 x FMA 1" - 6"	6"	.69"	1"	1.19"	2.2"	.38"	WF1-1.75	FMAKEY-1
22723-8	CAT50 x FMA 1" - 8"	8"	.69"	1"	1.19"	2.2"	.38"	WF1-1.75	FMAKEY-1
22723-10	CAT50 x FMA 1" - 10"	10"	.69"	1"	1.19"	2.2"	.38"	WF1-1.75	FMAKEY-1
22723-12	CAT50 x FMA 1" - 12"	12"	.69"	1"	1.19"	2.2"	.38"	WF1-1.75	FMAKEY-1
22725	CAT50 x FMA 1-1/4" - 1.50"	1.5"	.69"	1-1/4"	1.5"	2.75"	.5"	WF1.25-1.75	FMAKEY-1-1/4
22725-3.5	CAT50 x FMA 1-1/4" - 3.5"	3.5"	.69"	1-1/4"	1.5"	2.75"	.5"	WF1.25-1.75	FMAKEY-1-1/4
22725-6	CAT50 x FMA 1-1/4" - 6"	6"	.69"	1-1/4"	1.5"	2.75"	.5"	WF1.25-1.75	FMAKEY-1-1/4
22725-8	CAT50 x FMA 1-1/4" - 8"	8"	.69"	1-1/4"	1.5"	2.75"	.5"	WF1.25-1.75	FMAKEY-1-1/4
22725-10	CAT50 x FMA 1-1/4" - 10"	10"	.69"	1-1/4"	1.5"	2.75"	.5"	WF1.25-1.75	FMAKEY-1-1/4
22725-12	CAT50 x FMA 1-1/4" - 12"	12"	.69"	1-1/4"	1.5"	2.75"	.5"	WF1.25-1.75	FMAKEY-1-1/4
22727	CAT50 x FMA 1-1/2" - 2.4"	2.4"	.94"	1-1/2"	1.88"	3.8"	.63"	WF1.5-1.75	FMAKEY-1-1/2
22727-4	CAT50 x FMA 1-1/2" - 4"	4"	.94"	1-1/2"	1.88"	3.8"	.63"	WF1.5-1.75	FMAKEY-1-1/2
22727-6	CAT50 x FMA 1-1/2" - 6"	6"	.94"	1-1/2"	1.88"	3.8"	.63"	WF1.5-1.75	FMAKEY-1-1/2
22727-8	CAT50 x FMA 1-1/2" - 8"	8"	.94"	1-1/2"	1.88"	3.8"	.63"	WF1.5-1.75	FMAKEY-1-1/2
22727-10	CAT 50 x FMA 1-1/2" - 10"	10"	.94"	1-1/2"	1.88"	3.8"	.63"	WF1.5-1.75	FMAKEY-1-1/2
22729	CAT50 x FMA 2" - 2.4"	2.4"	.94"	2"	2.5"	4.88"	.75"	WF2	FMAKEY-2
22729-4	CAT50 x FMA 2" - 4"	4"	.94"	2"	2.5"	4.88"	.75"	WF2	FMAKEY-2

All Techniks Face Mill Arbors come with the solid arbor screw and keys listed.



pg. 152



pg. 229



pg. 236



pg. 238

# CAT50 FACE MILL ARBORS - DUALDRIVE



Techniks Certified for accuracy and balance. Each holder comes with a complete lab report. Taper ground to AT3 tolerance or better.

## CAT50 FACE MILL ARBORS **DUALDRIVE**

### FEATURES

- Techniks Certified for dual-contact spindles
- Better rigidity and reduced vibration
- Improved performance at high metal removal rates or when machining at extended length

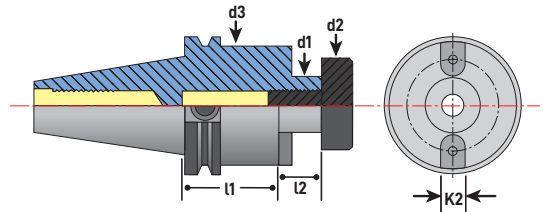

Part No.	Description	l1	l2	d1	d2	d3	K2	Screw	Key
44.151.64.150	CAT50 x FMA 3/4" - 1.5" DualDRIVE	1.5"	.69"	3/4"	.88"	2.75"	.31"	WF0.75-1.5	FMAKEY-3/4
44.151.64.350	CAT50 x FMA 3/4" - 3.5" DualDRIVE	3.5"	.69"	3/4"	.88"	1.69"	.31"	WF0.75-1.5	FMAKEY-3/4
44.151.64.400	SCAT 50 x FMA 3/4" - 4" DualDRIVE	4"	.69"	3/4"	.88"	2.75"	.31"	WF0.75-1.5	FMAKEY-3/4
44.151.64.550	CAT50 x FMA 3/4" - 5.5" DualDRIVE	5.5"	.69"	3/4"	.88"	1.69"	.31"	WF0.75-1.5	FMAKEY-3/4
44.151.64.800	SCAT 50 x FMA 3/4" - 8" DualDRIVE	8"	.69"	3/4"	.88"	2.75"	.31"	WF0.75-1.5	FMAKEY-3/4
44.151.64.100	SCAT 50 x FMA 3/4" - 10" DualDRIVE	10"	.69"	3/4"	.88"	2.75"	.31"	WF0.75-1.5	FMAKEY-3/4
44.151.68.200	CAT50 x FMA 1" - 2" DualDRIVE	2"	.69"	1"	1.19"	2.2"	.38"	WF1-1.75	FMAKEY-1
44.151.68.400	CAT50 x FMA 1" - 4" DualDRIVE	4"	.69"	1"	1.19"	2.2"	.38"	WF1-1.75	FMAKEY-1
44.151.68.600	CAT50 x FMA 1" - 6" DualDRIVE	6"	.69"	1"	1.19"	2.2"	.38"	WF1-1.75	FMAKEY-1
44.151.68.700	SCAT 50 x FMA 1" - 7" DualDRIVE	7"	.69"	1"	1.19"	2.2"	.38"	WF1-1.75	FMAKEY-1
44.151.68.100	SCAT 50 x FMA 1" - 10" DualDRIVE	10"	.69"	1"	1.19"	2.2"	.38"	WF1-1.75	FMAKEY-1
44.151.72.150	CAT50 x FMA 1-1/4" - 1.5" DualDRIVE	1.5"	.69"	1-1/4"	1.5"	2.75"	.5"	WF1-1/4	FMAKEY-1-1/4
44.151.72.350	CAT50 x FMA 1-1/4" - 3.5" DualDRIVE	3.5"	.69"	1-1/4"	1.5"	2.75"	.5"	WF1-1/4	FMAKEY-1-1/4
44.151.72.600	CAT50 x FMA 1-1/4" - 6" DualDRIVE	6"	.69"	1-1/4"	1.5"	2.75"	.5"	WF1-1/4	FMAKEY-1-1/4
44.151.77.240	CAT50 x FMA 1-1/2" - 2.4" DualDRIVE	2.4"	.94"	1-1/2"	1.88"	3.8"	.63"	WF1-1/2	FMAKEY-1-1/2
44.151.77.400	CAT50 x FMA 1-1/2" - 4" DualDRIVE	4"	.94"	1-1/2"	1.88"	3.8"	.63"	WF1-1/2	FMAKEY-1-1/2
44.151.77.600	CAT50 x FMA 1-1/2" - 6" DualDRIVE	6"	.94"	1-1/2"	1.88"	3.8"	.63"	WF1-1/2	FMAKEY-1-1/2
44.151.77.800	CAT50 x FMA 1-1/2" - 8" DualDRIVE	8"	.94"	1-1/2"	1.88"	3.8"	.63"	WF1-1/2	FMAKEY-1-1/2
44.151.86.240	CAT50 x FMA 2" - 2.4" DualDRIVE	2.4"	.94"	2"	2.5"	4.88"	.75"	WF2	FMAKEY-2
44.151.86.400	CAT50 x FMA 2" - 4" DualDRIVE	4"	.94"	2"	2.5"	4.88"	.75"	WF2	FMAKEY-2

All Techniks Face Mill Arbors come with the solid arbor screw and keys listed.

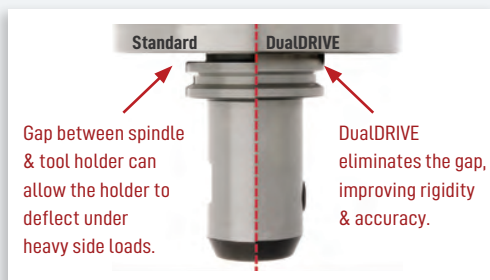

### DUAL-CONTACT SPINDLES

Dual-Contact is a spindle option offered by some machine tool builders where both the toolholder taper and the flange make contact with the spindle. The dual-contact provides increased rigidity and accuracy during heavy side loads.



# BT30 FACE MILL ARBORS



Techniks Certified for accuracy and balance. Each holder comes with a complete lab report. Taper ground to AT3 tolerance or better.

## FEATURES

- Compatible with all face mills
- H6 arbor tolerance for less chatter
- Taper ground to AT3 tolerance or better

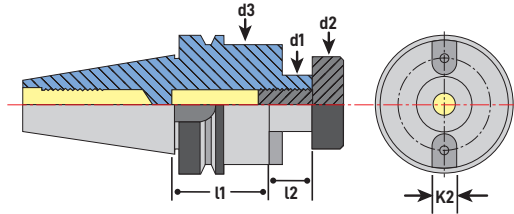

## BT30 FACE MILL ARBORS

Part No.	Description	l1	l2	d1	d2	d3	K2	Screw	Key
16611	BT30 x FMA 3/4" - 1.18"	1.18"	.69"	3/4"	.88"	1.66"	.313"	WF0.75-1.5	FMAKEY-3/4
16611-4	BT 30 x FMA 3/4" - 4"	4"	.69"	3/4"	.88"	1.66"	.313"	WF0.75-1.5	FMAKEY-3/4
16612	BT30 x FMA 1" - 1.77"	1.77"	.69"	1"	1.18"	2.2"	.375"	WF1-1.75	FMAKEY-1
16614	BT30 x FMA 1-1/4" - 1.77"	1.77"	.87"	1-1/4"	1.5"	2.37"	.5"	WF1.25-1.75	FMAKEY-1-1/4
16614-2.77	BT 30 x FMA 1-1/4" - 2.77"	2.77"	.87"	1-1/4"	1.5"	2.37"	.5"	WF1.25-1.75	FMAKEY-1-1/4

All Techniks Face Mill Arbors come with the solid arbor screw and keys listed.

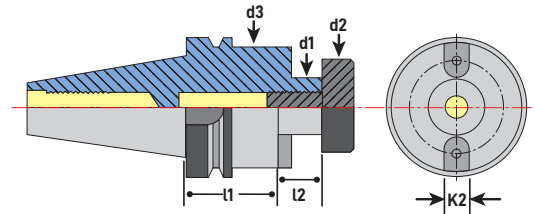

## BT30 FACE MILL ARBORS **DUALDRIVE**

Part No.	Description	l1	l2	d1	d2	d3	K2	Screw	Key
25.151.64.200	BT30 x FMA 3/4" - 2" DualDRIVE	2"	.69"	3/4"	.88"	1.66"	.313"	WF0.75-1.5	FMAKEY-3/4
25.151.68.200	BT30 x FMA 1" - 2" DualDRIVE	2"	.69"	1"	1.18"	2.2"	.375"	WF1-1.75	FMAKEY-1
25.151.72.177	BT 30 x FMA 1-1/4" - 1.77" DualDRIVE	1.77"	.87"	1-1/4"	1.5"	2.37"	.5"	WF1.25-1.75	FMAKEY-1-1/4
25.151.77.200	BT 30 x FMA 1-1/2" - 2" DualDRIVE	2"	.98"	1-1/2"	1.75"	2.95"	.62"	WF1-1/2	FMAKEY-1-1/2

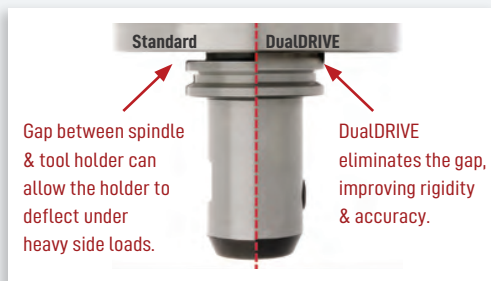

Standard  
Gap between spindle & tool holder can allow the holder to deflect under heavy side loads.

DualDRIVE  
DualDRIVE eliminates the gap, improving rigidity & accuracy.

## DUAL-CONTACT SPINDLES

Dual-Contact is a spindle option offered by some machine tool builders where both the toolholder taper and the flange make contact with the spindle. The dual-contact provides increased rigidity and accuracy during heavy side loads.



pg. 152



pg. 229



pg. 236



pg. 238

# BT40 / BT50 FACE MILL ARBORS

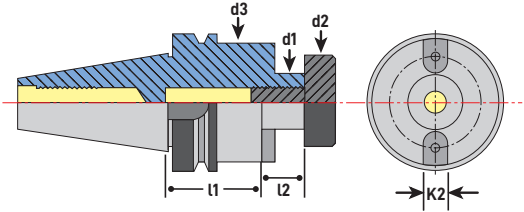

## BT40 FACE MILL ARBORS

Part No.	Description	l1	l2	d1	d2	d3	K2	Screw	Key
16615-3/4	BT40 x FMA 3/4" - 1"	1"	.69"	3/4"	.88"	1.69"	.313"	WF0.75-1.5	FMAKEY-3/4
16615-4	BT40 x FMA 3/4" - 4"	4"	.69"	3/4"	.88"	1.69"	.313"	WF0.75-1.5	FMAKEY-3/4
16615-6	BT40 x FMA 3/4" - 6"	6"	.69"	3/4"	.88"	1.69"	.313"	WF0.75-1.5	FMAKEY-3/4
16615	BT40 x FMA 1" - 1.77"	1.77"	.69"	1"	1.18"	2.2"	.375"	WF1-1.75	FMAKEY-1
16617	BT40 x FMA 1" - 3.54"	3.54"	.69"	1"	1.18"	2.2"	.375"	WF1-1.75	FMAKEY-1
16620	BT40 x FMA 1-1/4" - 1.77"	1.77"	.69"	1-1/4"	1.5"	2.75"	.5"	WF1.25-1.75	FMAKEY-1-1/4
16620-4	BT40 x FMA 1-1/4" - 4"	4"	.69"	1-1/4"	1.5"	2.75"	.5"	WF1.25-1.75	FMAKEY-1-1/4
16626	BT40 x FMA 1-1/2" - 2.36"	2.36"	.94"	1-1/2"	1.88"	3.8"	.625"	WF1.5-1.75	FMAKEY-1-1/2

## BT50 FACE MILL ARBORS

Part No.	Description	l1	l2	d1	d2	d3	K2	Screw	Key
16639	BT50 x 1" - 1.77"	1.77"	.79"	1"	1.19"	1.97	.375"	WF1-1.75	FMAKEY-1
16639-3	BT50 x 1" - 3"	3"	.79"	1"	1.19"	1.97	.375"	WF1-1.75	FMAKEY-1
16642	BT50 x 1-1/4" - 1.77"	1.77"	.87"	1-1/4"	1.5"	2.34"	.5"	WF1.25-1.75	FMAKEY-1-1/4
16645	BT50 x 1-1/2" - 1.77"	1.77"	.94"	1-1/2"	1.88"	3.8"	.625"	WF1.5-1.75	FMAKEY-1-1/2
16646	BT50 x 1-1/2" - 2.95"	2.95"	.94"	1-1/2"	1.88"	3.8"	.625"	WF1.5-1.75	FMAKEY-1-1/2
16646-105	BT50 x 1-1/2" - 4.13"	4.13"	.94"	1-1/2"	1.88"	3.8"	.625"	WF1.5-1.75	FMAKEY-1-1/2
16646-150	BT50 x 1-1/2" - 5.9"	5.9"	.94"	1-1/2"	1.88"	3.8"	.625"	WF1.5-1.75	FMAKEY-1-1/2
16648	BT50 x 2" - 2.95"	2.95"	.94"	2"	3.13"	4.88"	.75"	WF2	FMAKEY-2

## BT50 FACE MILL ARBORS **DUALDRIVE**

Part No.	Description	l1	l2	d1	d2	d3	K2	Screw	Key
27.151.64.200	SBT 50 x FMA 3/4" - 2" DualDRIVE	2"	.69"	3/4"	.88"	2.75"	.31"	WF0.75-1.5	FMAKEY-3/4
27.151.72.400	SBT 50 x FMA 1-1/4" - 4" DualDRIVE	4"	.87"	1-1/4"	1.5"	2.34"	.5"	WF1.25-1.75	FMAKEY-1-1/4

All Techniks Face Mill Arbors come with the solid arbor screw and keys listed.



We stand behind all our products with our 100% Satisfaction Guarantee • [www.techniksusa.com](http://www.techniksusa.com)



# HSK63A / HSK63F FACE MILL ARBORS

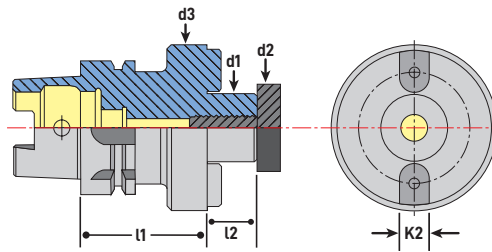

## HSK63A FACE MILL ARBORS

Part No.	Description	l1	l2	d1	d2	d3	K2	Screw	Key
93500	HSK63A x FMA 3/4" - 2"	2"	.69"	3/4"	.88"	1.69"	.313"	WF0.75-1.5	FMAKEY-3/4
93510	HSK63A x FMA 3/4" - 4"	4"	.69"	3/4"	.88"	1.69"	.313"	WF0.75-1.5	FMAKEY-3/4
93510-8	HSK63A x FMA 3/4" - 8"	8"	.69"	3/4"	.88"	1.69"	.313"	WF0.75-1.5	FMAKEY-3/4
93501	HSK63A x FMA 1" - 2.37"	2.37"	.69"	1"	1.24"	2.2"	.375"	WF1-1.75	FMAKEY-1
93520	HSK63A x FMA 1" - 4"	4"	.69"	1"	1.24"	2.2"	.375"	WF1-1.75	FMAKEY-1
93520-6	HSK63A x FMA 1" - 6"	6"	.69"	1"	1.24"	2.2"	.375"	WF1-1.75	FMAKEY-1
93520-8	HSK63A x FMA 1" - 8"	8"	.69"	1"	1.24"	2.2"	.375"	WF1-1.75	FMAKEY-1
93502	HSK63A x FMA 1-1/4" - 2.75"	2.75"	.69"	1-1/4"	1.5"	2.75"	.5"	WF1.25-1.75	FMAKEY-1-1/4
93530	HSK63A x FMA 1-1/4" - 4"	4"	.69"	1-1/4"	1.5"	2.75"	.5"	WF1.25-1.75	FMAKEY-1-1/4
93530-6	HSK63A x FMA 1-1/4" - 6"	6"	.69"	1-1/4"	1.5"	2.75"	.5"	WF1.25-1.75	FMAKEY-1-1/4
93530-8	HSK63A x FMA 1-1/4" - 8"	8"	.69"	1-1/4"	1.5"	2.75"	.5"	WF1.25-1.75	FMAKEY-1-1/4
93550	HSK63A x FMA 1-1/2" - 4"	4"	.94"	1-1/2"	1.88"	3.8"	.63"	WF1.5-1.75	FMAKEY-1-1/2

All Techniks Face Mill Arbors come with the solid arbor screw and keys listed.

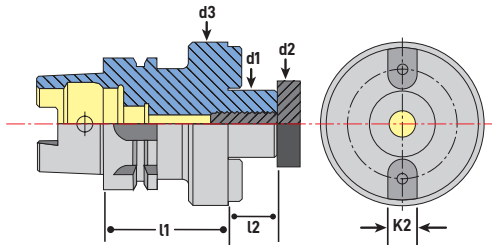

## HSK63F FACE MILL ARBORS

Part No.	Description - I.D.	l1	l2	d1	d2	d3	K2	Screw	Key
93509-F	HSK63F x FMA 1/2" - 4"	4"	.55"	1/2"	.66"	1.45"	.25"	WF0.5	FMAKEY-1/2
93510-F	HSK63F x FMA 3/4" - 4"	4"	.69"	3/4"	.88"	1.69"	.31"	WF0.75-1.5	FMAKEY-3/4
93520-F	HSK63F x FMA 1" - 4"	4"	.69"	1"	1.19"	2.2"	.38"	WF1-1.75	FMAKEY-1
93502-F	HSK63F x FMA 1-1/4" - 2.75"	2.75"	.69"	1-1/4"	1.5"	2.75"	.5"	WF1.25-1.75	FMAKEY-1-1/4
93530-F	HSK63F x FMA 1-1/4" - 4"	4"	.69"	1-1/4"	1.50"	2.75"	.5"	WF1.25-1.75	FMAKEY-1-1/4
93550-F	HSK63F x FMA 1-1/2" - 4"	4"	.94"	1-1/2"	1.88"	3.8"	.63"	WF1.5-1.75	FMAKEY-1-1/2

All Techniks Face Mill Arbors come with the solid arbor screw and keys listed.



pg. 152



pg. 229



pg. 236



pg. 238

# HSK100A / R8 FACE MILL ARBORS

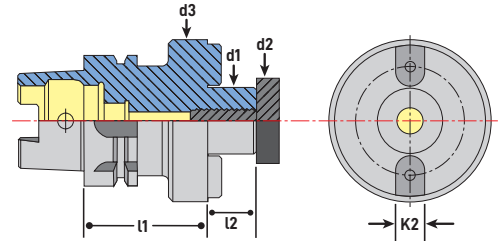

## HSK100A FACE MILL ARBORS

Part No.	Description	l1	l2	d1	d2	d3	K2	Screw	Key
95901	HSK100A x FMA 3/4" - 2"	2"	.69"	3/4"	.88"	1.69"	.31"	WF0.75-1.5	FMAKEY-3/4
95901-4	HSK100A x FMA 3/4" - 4"	4"	.69"	3/4"	.88"	1.69"	.31"	WF0.75-1.5	FMAKEY-3/4
95901-6	HSK100A x FMA 3/4" - 6"	6"	.69"	3/4"	.88"	1.69"	.31"	WF0.75-1.5	FMAKEY-3/4
95901-12	HSK100A x FMA 3/4" - 12"	12"	.69"	3/4"	.88"	1.69"	.31"	WF0.75-1.5	FMAKEY-3/4
95903	HSK100A x FMA 1" - 2"	2"	.69"	1"	1.19"	2.2"	.38"	WF1-1.75	FMAKEY-1
95903-6	HSK100A x FMA 1" - 6"	6"	.69"	1"	1.19"	2.2"	.38"	WF1-1.75	FMAKEY-1
95903-7	HSK100A x FMA 1" - 7"	7"	.69"	1"	1.19"	2.2"	.38"	WF1-1.75	FMAKEY-1
95903-10	HSK100A x FMA 1" - 10"	10"	.69"	1"	1.19"	2.2"	.38"	WF1-1.75	FMAKEY-1
95903-12	HSK100A X FMA 1" - 12"	12"	.69"	1"	1.19"	2.2"	.38"	WF1-1.75	FMAKEY-1
95903-14	HSK100A x FMA 1" - 14"	14"	.69"	1"	1.19"	2.2"	.38"	WF1-1.75	FMAKEY-1
95905	HSK100A x FMA 1-1/4" - 2.5"	2.5"	.69"	1-1/4"	1.5"	2.75"	.5"	WF1.25-1.75	FMAKEY-1-1/4
95905-6	HSK100A x FMA 1-1/4" - 6"	6"	.69"	1-1/4"	1.5"	2.75"	.5"	WF1.25-1.75	FMAKEY-1-1/4
95905-9	HSK100A x FMA 1-1/4" - 9"	9"	.69"	1-1/4"	1.5"	2.75"	.5"	WF1.25-1.75	FMAKEY-1-1/4
95907	HSK100A x FMA 1-1/2" - 2.5"	2.5"	.94"	1-1/2"	1.88"	3.8"	.63"	WF1.5-1.75	FMAKEY-1-1/2
95907-4	HSK100A x FMA 1-1/2" - 4"	4"	.94"	1-1/2"	1.88"	3.8"	.63"	WF1.5-1.75	FMAKEY-1-1/2
95907-6	HSK100A x FMA 1-1/2" - 6"	6"	.94"	1-1/2"	1.88"	3.8"	.63"	WF1.5-1.75	FMAKEY-1-1/2
95907-10	HSK100A x FMA 1-1/2" - 10"	10"	.94"	1-1/2"	1.88"	3.8"	.63"	WF1.5-1.75	FMAKEY-1-1/2
95907-15	HSK100A X FMA 1-1/2" - 15"	15"	.94"	1-1/2"	1.88"	3.8"	.63"	WF1.5-1.75	FMAKEY-1-1/2

All Techniks Face Mill Arbors come with the solid arbor screw and keys listed.

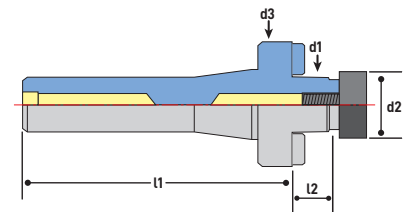

## R8 FACE MILL ARBORS

Part No.	Description	l1	l2	d1	d2	d3	K2	Screw	Key
7582401	R8 x FMA - 3/4"	4.7"	.675"	3/4"	.88"	1.93"	.37"	WF0.75-1.5	FMAKEY-3/4
7582402	R8 x FMA - 1"	4.85"	.85"	1"	1.19"	1.81"	.38"	WF1-1.75	FMAKEY-1
7582403	R8 x FMA - 1-1/4"	4.9"	.75"	1-1/4"	1.25"	2.28"	.5"	WF1.25-1.75	FMAKEY-1-1/4

All Techniks Face Mill Arbors come with the solid arbor screw and keys listed.



# FACE MILL ARBOR SCREWS



## FEATURES

- Compatible with all face mills
- Works with all Techniks face mill arbors
- For coolant up to 1,500 PSI

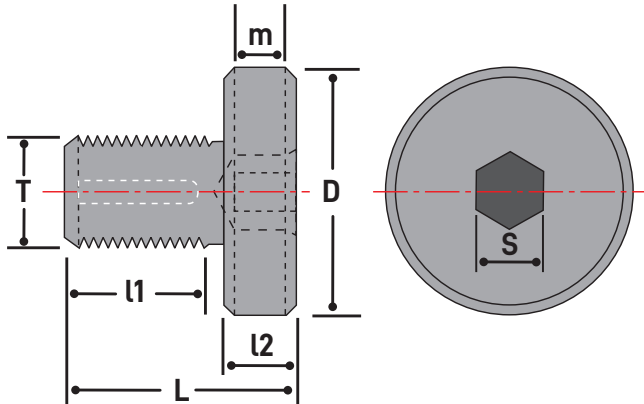

CoolBLAST arbor screw provides coolant path.

## STANDARD ARBOR SCREWS

Part No.	Description	Arbor Size	D	L	l1	l2	T	S	m
WF0.5	FMA screw 1/2"	1/2"	5/8"	.84"	.5"	.34"	1/4"-28UNF	3/16"	.157"
WF0.75-1.5	FMA screw 3/4"	3/4"	7/8"	1.8"	1.4"	.37"	3/8"-24UNF	1/4"	.197"
WF1-1.75	FMA screw 1"	1"	1-3/16"	1.4"	0.81"	.37"	1/2"-20UNF	5/16"	.197"
WF1.25-1.75	FMA screw 1-1/4"	1-1/4"	1-1/2"	1.44"	0.94"	.5"	5/8"-18UNF	5/16"	.236"
WF1.5-1.75	FMA screw 1-1/2"	1-1/2"	1-7/8"	1.63"	1.13"	.5"	3/4"-16UNF	3/8"	.276"
WF2	FMA screw 2"	2"	2-1/2"	1.81"	1.31"	.5"	1"-14UNF	1/2"	.354"

## COOLBLAST COOLANT ARBOR SCREWS

Part No.	Description	Style	Size	D	L	l1	l2	T	S	m
WFC1-0.5	CoolBLAST arbor screw 1/2"	B	1/2"	5/8"	.84"	.5"	.34"	1/4"-28UNF	3/16"	.187"
WFC1-0.75	CoolBLAST arbor screw 3/4"	B	3/4"	7/8"	1.37"	1"	.37"	3/8"-24UNF	1/4"	.196"
9851125	CAS-A-0.75 smaller "D"	A	3/4"	5/8"	1.37"	1"	.37"	3/8"-24UNF	1/4"	.218"
WFC1-1-1.75	CoolBLAST arbor screw 1"	B	1"	1-3/16"	1.37"	1"	.37"	1/2"-20UNF	5/16"	.197"
9851135	CAS-A-1.00 smaller "D"	A	1"	3/4"	2.12"	1.75"	.37"	1/2"-20UNF	5/16"	.218"
WFC1-1.25-1.75	CoolBLAST arbor screw 1-1/4"	B	1-1/4"	1-1/2"	1.75"	1.25"	.5"	5/8"-18UNF	5/16"	.250"
WFC1-1.5-1.75	CoolBLAST arbor screw 1-1/2"	B	1-1/2"	1-7/8"	1.75"	1.25"	.5"	3/4"-16UNF	3/8"	.312"
WFC1-2-2	CoolBLAST arbor screw 2"	B	2"	2-1/2"	2"	1.5"	.5"	1"-14UNF	1/2"	.375"



# CAPTO-COMPATIBLE\* HOLDERS

THE C4, C5, AND C6 HOLDERS YOU NEED - TECHNIKS CERTIFIED.



ER Collet Chucks



End Mill Holders



ShrinkFIT



Face Mill  
Arbors



Turning Tools & Inserts



SlimFIT Holders

\*CAPTO IS A TRADEMARK OF SANDVIK AB AND USED FOR IDENTIFICATION ONLY.





For turn/mill machines that accept "PSC" style toolholders. Coolant-thru is standard feature.

## FEATURES

- Balanced to 25,000 RPM at G2.5
- Maximum T.I.R. 0.0001" measured from taper to collet pocket
- PowerCOAT Nut included and increases holding power by 75%

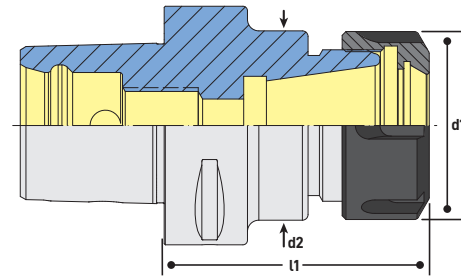

## C4 ER COLLET CHUCKS

Part No.	Description	l1	d1	d2	Max Shank	Wrench
141.122.16.070	C4 x ER16 - 70mm	70mm	28mm	28mm	10mm	04609
141.122.25.052	C4 x ER25 - 52mm	52mm	42mm	42mm	16mm	04615
141.122.32.054	C4 x ER32 - 54mm	54mm	50mm	50mm	20mm	04616

## C5 ER COLLET CHUCKS

Part No.	Description	l1	d1	d2	Max Shank	Wrench
142.122.16.100	C5 x ER16 - 100mm	100mm	28mm	28mm	10mm	04609
142.122.25.055	C5 x ER25 - 55mm	55mm	42mm	42mm	16mm	04615
142.122.32.057	C5 x ER 32 - 57mm	57mm	50mm	50mm	20mm	04616

## C6 ER COLLET CHUCKS

Part No.	Description	l1	d1	d2	Max Shank	Wrench
143.122.16.100	C6 x ER16 - 100mm	100mm	28mm	28mm	10mm	04609
143.122.25.060	C6 x ER25 - 60mm	60mm	42mm	42mm	16mm	04615
143.122.32.070	C6 x ER32 - 70mm	70mm	50mm	50mm	20mm	04616
143.122.40.065	C6 x ER40 - 65mm	65mm	63mm	63mm	26mm	04617
143.123.08.600	C6 x ER8M - 6" mini nut	6"	.47"	.63"	.187"	04620
143.123.11.600	C6 x ER11M - 6" mini nut	6"	.75"	.79"	.275"	04621
143.123.16.600	C6 x ER16M - 6" mini nut	6"	.87"	.98"	.406"	04622
143.123.20.600	C6 x ER20M - 6" mini nut	6"	1.10"	1.26"	.512"	04623

\*CAPTO is a trademark of Sandvik AB and used for identification only.



## FEATURES

- .550" nose diameters
- Balanced to 25,000 RPM at G2.5
- "On-Size" noncollapsible collets

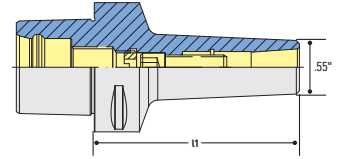

For turn/mill machines that accept "PSC" style toolholders. Coolant-thru is standard feature.

## C4 & C6 SLIMFIT COLLET CHUCKS

Part No.	Description	l1	Drawbar
141.648.06.075	C4 x SBL 6 - 75mm	75mm	SBL-M6CT-20
143.648.06.080	C6 x SBL 6 - 80mm	80mm	SBL-M6CT-20

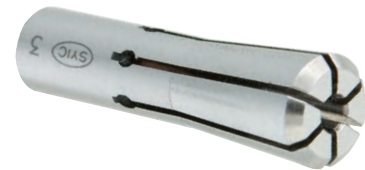

## SLIMFIT COLLETS

Part No.	Description
18851-3/32	SlimFIT 6 - 3/32" collet
18851-7/64	SlimFIT 6 - 7/64" collet
18851-1/8	SlimFIT 6 - 1/8" collet
18851-9/64	SlimFIT 6 - 9/64" collet
18851-5/32	SlimFIT 6 - 5/32" collet
18851-11/64	SlimFIT 6 - 11/64" collet
18851-3/16	SlimFIT 6 - 3/16" collet
18851-13/64	SlimFIT 6 - 13/64" collet
18851-7/32	SlimFIT 6 - 7/32" collet
18851-15/64	SlimFIT 6 - 15/64" collet
18851-1/4	SlimFIT 6 - 1/4" collet
18851-02	SlimFIT 6 - 2mm collet
18851-03	SlimFIT 6 - 3mm collet
18851-04	SlimFIT 6 - 4mm collet
18851-05	SlimFIT 6 - 5mm collet
18851-05.5	SlimFIT 6 - 5.5mm collet
18851-06	SlimFIT 6 - 6mm collet
Collet Set	18851-12IMS

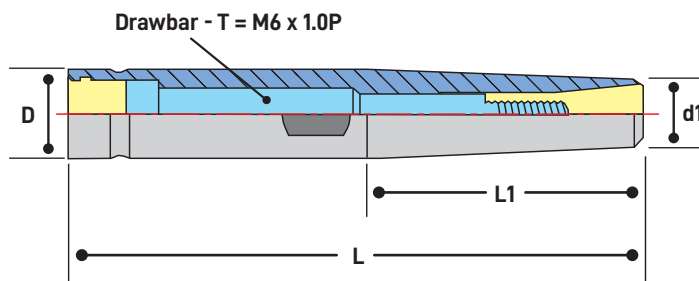

## SLIMFIT EXTENSIONS

Part No.	Description	D	L	l1	d1
06032-3	1/2" x OLP6-3" extension	1/2"	3"	1.89"	.48
06032	1/2" x OLP6-5" extension	1/2"	5"	1.89"	.48
06034	1/2" x OLP6-6" extension	1/2"	6"	1.89"	.48
06038	5/8" x OLP6-5" extension	5/8"	5"	1.89"	.48
06040	5/8" x OLP6-6" extension	5/8"	6"	1.89"	.48
06042	5/8" x OLP6-8" extension	5/8"	8"	1.89"	.48

Note: Extensions Fit 1/2" or 5/8" Toolholders





For turn/mill machines that accept "PSC" style toolholders.  
Coolant-thru is standard feature.

## FEATURES

- Extends cutting tool life 60%
- Balanced to 15,000 RPM at G6.3
- High precision bore (H5) is best in the industry

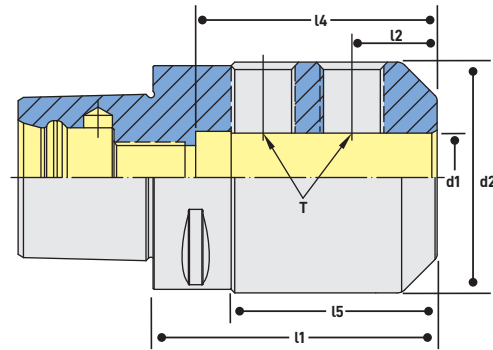

## C4 ENDMILL HOLDERS

Part No.	Description	l1	l2	l4	l5	d1	d2	T
141.653.54.197	C4 x SLN 1/4" - 1.97"	1.97"	.63"	1.38"	1"	1/4"	.78"	1/4-28"
141.653.55.197	C4 x SLN 5/16" - 1.97"	1.97"	.63"	1.38"	1.02"	5/16"	.88"	5/16-24"
141.653.56.197	C4 x SLN 3/8" - 1.97"	1.97"	.75"	1.535"	1.08"	3/8"	1"	3/8-24"
141.653.58.217	C4 x SLN 1/2" - 2.17"	2.17"	.875"	1.732"	1.42"	1/2"	1.25"	7/16-20"
141.653.61.217	C4 x SLN 5/8" - 2.17"	2.17"	.875"	1.732"	1.54"	5/8"	1.5"	7/16-20"

## C6 ENDMILL HOLDERS

Part No.	Description	l1	l2	l4	l5	d1	d2	T
143.653.54.217	C6 x SLN 1/4" - 2.17"	2.17"	.63"	1.38"	.984"	1/4"	.78"	1/4-28"
143.653.55.217	C6 x SLN 5/16" - 2.17"	2.17"	.63"	1.38"	1.024"	5/16"	.88"	5/16-24"
143.653.56.236	C6 x SLN 3/8" - 2.36"	2.36"	.75"	1.535"	1.181"	3/8"	1"	3/8-24"
143.653.58.236	C6 x SLN 1/2" - 2.36"	2.36"	.875"	1.732"	1.299"	1/2"	1.25"	7/16-20"
143.653.61.256	C6 x SLN 5/8" - 2.56"	2.56"	.937"	1.732"	1.398"	5/8"	1.5"	1/2-20"
143.653.64.256	C6 x SLN 3/4" - 2.56"	2.56"	1"	1.929"	1.476"	3/4"	1.75"	5/8-18"
143.653.68.315	C6 x SLN 1" - 3.15"	3.15"	1.125"	2.559"	2.283"	1"	2"	3/4-16"
143.653.72.354	C6 x SLN 1-1/4" - 3.54"	3.54"	1.125"	2.559"	2.677"	1-1/4"	2.5"	3/4-16"

\*CAPTO is a trademark of Sandvik AB and used for identification only.



pg. 229



pg. 236



pg. 238

# CAPTO-COMPATIBLE\* SHRINKFIT HOLDERS



## FEATURES

- Maximum T.I.R. only 0.0001"
- Balanced to 25,000 RPM at G2.5
- Superior rigidity and holding power

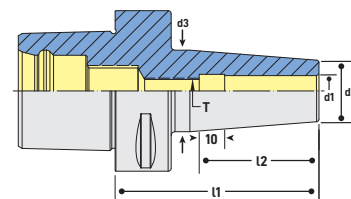

## C4 SHRINKFIT CHUCKS

Part No.	Description	l1	l2	d1	d2	d3	T	Coolant Stop Screw
141.651.54.295	C4 x SF 1/4" - 2.95"	2.95"	1.41"	1/4"	.83"	1.06"	M5 x .8P	16080C-20
141.651.55.295	C4 x SF 5/16" - 2.95"	2.95"	1.41"	5/16"	.83"	1.06"	M6 x 1.0P	16081C-20
141.651.56.295	C4 x SF 3/8" - 2.95"	2.95"	1.61"	3/8"	.95"	1.26"	M8 x 1.25P	16082C-20
141.651.58.295	C4 x SF 1/2" - 2.95"	2.95"	1.81"	1/2"	1.10"	1.34"	M10 x 1.5P	16083C-20
141.651.61.315	C4 x SF 5/8" - 3.15"	3.15"	1.93"	5/8"	1.06"	1.34"	M12 x 1.75P	16085C-20

## C5 SHRINKFIT CHUCKS

Part No.	Description	l1	l2	d1	d2	d3	T	Coolant Stop Screw
142.651.52.315	C5 x SF 1/8 - 80mm	3.15"	1.5"	1/8"	.63"	.87"	M6 x 1.0P	16081C-20
142.651.53.315	C5 x SF 3/16 - 80mm	3.15"	1.5"	3/16"	.63"	.87"	M6 x 1.0P	16081C-20
142.651.54.315	C5 x SF 1/4 - 80mm	3.15"	1.5"	1/4"	.83"	1.06"	M5 x .8P	16080C-20
142.651.56.315	C5 x SF 3/8 - 80mm	3.15"	2"	3/8"	.95"	1.26"	M8 x 1.25P	16082C-20
142.651.58.315	C5 x SF 1/2 - 80mm	3.15"	1.5"	1/2"	1.10"	1.34"	M10 x 1.5P	16083C-20
142.651.61.315	C5 x SF 5/8 - 80mm	3.15"	1.75"	5/8"	1.06"	1.34"	M12 x 1.75P	16085C-20
142.651.64.315	C5 x SF 3/4 - 80mm	3.15"	1.5"	3/4"	1.42"	1.65"	M16 x 2.0P	16089C-20

## C6 SHRINKFIT CHUCKS

Part No.	Description	l1	l2	d1	d2	d3	T	Coolant Stop Screw
143.651.52.300	C6 x SF 1/8" - 3"	3"	1.77"	1/8"	.36"	.64"	M6 x 1.0P	16081C-20
143.651.53.300	C6 x SF 3/16" - 3"	3"	1.77"	3/16"	.43"	.70"	M6 x 1.0P	16081C-20
143.651.54.315	C6 x SF 1/4" - 3.15"	3.15"	1.41"	1/4"	.83"	1.06"	M5 x .8P	16080C-20
143.651.55.315	C6 x SF 5/16" - 3.15"	3.15"	1.41"	5/16"	.83"	1.06"	M6 x 1.0P	16081C-20
143.651.56.315	C6 x SF 3/8" - 3.15"	3.15"	1.61"	3/8"	.95"	1.26"	M8 x 1.25P	16082C-20
143.651.58.315	C6 x SF 1/2" - 3.15"	3.15"	1.81"	1/2"	1.10"	1.34"	M10 x 1.5P	16083C-20
143.651.61.335	C6 x SF 5/8" - 3.35"	3.35"	1.93"	5/8"	1.06"	1.34"	M12 x 1.75P	16085C-20
143.651.64.335	C6 x SF 3/4" - 3.35"	3.35"	2"	3/4"	1.26"	1.65"	M16 x 2.0P	16089C-20
143.651.68.354	C6 x SF 1" - 3.54"	3.54"	2.24"	1"	1.73"	2.08"	M16 x 2.0P	16089C-20
143.651.72.374	C6 x SF 1-1/4" - 3.74"	3.74"	2.4"	1-1/4"	1.73"	2.08"	M16 x 2.0P	16089C-20

\*CAPTO is a trademark of Sandvik AB and used for identification only.



# CAPTO-COMPATIBLE\* FACE MILL ARBORS



## FEATURES

- Compatible with all face mills
- H6 arbor tolerance for less chatter & better tool life

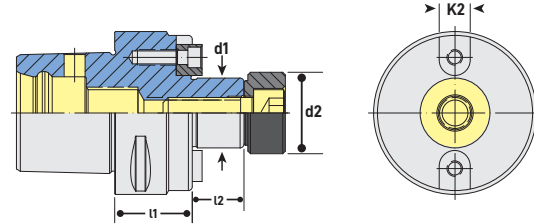

## C4, C5, C6 FACE MILL ARBORS

Part No.	Description	l1	l2	d1	d2	k2
141.151.64.100	C4 x FMA 3/4" - 1"	1"	.69"	3/4"	.88"	.314"
142.151.68.157	C5 x FMA 1" - 1.57"	1.57"	.69"	1"	1.24"	.375"
143.151.64.100	C6 x FMA 3/4" - 1"	1"	.69"	3/4"	.88"	.314"
143.151.68.200	C6 x FMA 1" - 2"	2"	.69"	1"	1.24"	.375"
143.151.72.200	C6 x FMA 1-1/4" - 2"	2"	.69"	1-1/4"	1.614"	.5"

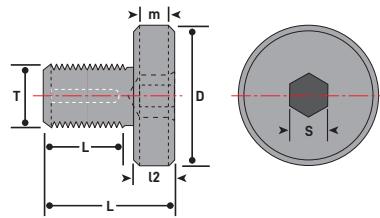

CoolBLAST arbor screw provides coolant path.

## COOLBLAST COOLANT ARBOR SCREWS

Part No.	Description	Arbor Size	D	L	l1	l2	T	S	m
WF.C1-.75-1.75	CoolBLAST arbor screw 3/4"	3/4"	7/8"	1.8"	1.4"	.37"	3/8"-24UNF	1/4"	.197"
9851125	CAS-A-.75 Smaller "D"	3/4"	5/8"	1.375"	1"	.36"	3/8"-24 UNF	1/4"	.37"
WF.C1-1-1.75	CoolBLAST arbor screw 1.0"	1"	1-3/16"	1.4"	.81"	.37"	1/2"-20UNF	5/16"	.197"
9851135	CAS-A-1.00 Smaller "D"	1"	3/4"	1.375"	1"	.38"	1/2"-20UNF	5/16"	.37"
WF.C1-1.25-1.75	CoolBLAST arbor screw 1-1/4"	1-1/4"	1-1/2"	1.44"	.94"	.5"	5/8"-18UNF	5/16"	.236"

## STANDARD ARBOR SCREWS

Part No.	Description	Arbor Size	D	L	l1	l2	T	S	m
WF.75-1.75	FMA arbor screw 3/4"	3/4"	7/8"	1.8"	1.4"	.37"	3/8"-24UNF	1/4"	.197"
WF1-1.75	FMA arbor screw 1"	1"	1-3/16"	1.4"	.81"	.37"	1/2"-20UNF	5/16"	.197"
WF1.25-1.75	FMA arbor screw 1-1/4"	1-1/4"	1-1/2"	1.44"	.94"	.5"	5/8"-18UNF	5/16"	.236"

\*CAPTO is a trademark of Sandvik AB and used for identification only.

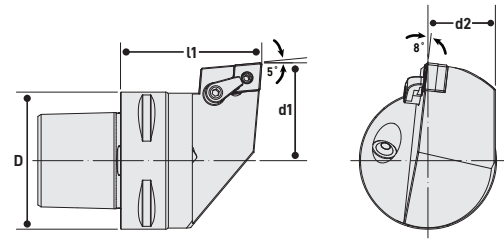

## C6 MCLN

Part No.	Description	l1	D	d1	d2	Insert	Clamp	Shim	Screw	Lock Pin
143.475.12L.065	C6 - MCLNL-DX12	65mm	63mm	45mm	31mm	CN_43_	MC620	CMS432	MS630	MLP46-A
143.475.12R.065	C6 - MCLNR-DX12	65mm	63mm	45mm	31mm	CN_43_	MC620	CMS432	MS630	MLP46-A

## CNMG INSERTS FOR NEGATIVE TURNING AND BORING

Part No.	Description	Grade	Radius	Operation	Material
6607029	CNMG431-NN	LT10	.016	finishing	P-M-K-S-H
6608011	CNMG431-NN	LT1000	.016	finishing	P-M-K-S-H
6607033	CNMG432-NN	LT10	.031	general	P-M-K-S-H
6608016	CNMG432-NN	LT1000	.031	general	P-M-K-S-H
6601436	CNMG432-NM	LT10	.031	roughing	P-M-K-S-H
6601446	CNMG432-NR	LT10	.031	roughing	P-M-K-S-H
6608026	CNMG432-NX	LT1000	.031	general	P-M-K-S-H
6607037	CNMG433-NN	LT10	.047	roughing	P-M-K-S-H
6608021	CNMG433-NN	LT1000	.047	roughing	P-M-K-S-H

We recommend LT1000 grade inserts for maximum insert performance. LT1000 grade features an advanced PVD coating that is 14 microns thick and lasts 250% longer than other inserts.



CNMG

## CNMM INSERTS FOR NEGATIVE TURNING AND BORING

Part No.	Description	Grade	Radius	Operation	Material
6602011	CNMM432-NR	LT10	.031	finish-medium	P-M-K-S-H
6602022	CNMM433-NR	LT10	.047	medium-rough	P-M-K-S-H



CNMM

## CNMP INSERTS FOR NEGATIVE TURNING AND BORING

Part No.	Description	Grade	Radius	Operation	Material
6607045	CNMP432-NN	LT10	.031	finish-medium	P-M-K-S-H
6608031	CNMP432-NN	LT1000	.031	finish-medium	P-M-K-S-H
3665525	CNMP433-NN	LT10	.047	medium-rough	P-M-K-S-H
6608036	CNMP433-NN	LT1000	.047	medium-rough	P-M-K-S-H



CNMP

## CNGG INSERTS FOR ALUMINUM NEGATIVE TURNING AND BORING

Part No.	Description	Grade	Radius	Operation	Material
6607901	CNGG431-ALU	LT05	.016	finishing	N
6607905	CNGG432-ALU	LT05	.031	general	N



CNGG

\*CAPTO is a trademark of Sandvik AB and used for identification only.

P = steel, M = stainless, K = cast iron, S = high temp alloys, H = hardened material, N = aluminum & alloys

# CAPTO-COMPATIBLE\* TURNING TOOLS



For turn/mill machines that accept "PSC" style toolholders.

## FEATURES

- High accuracy for best repeatability
- Turning, boring, threading and grooving

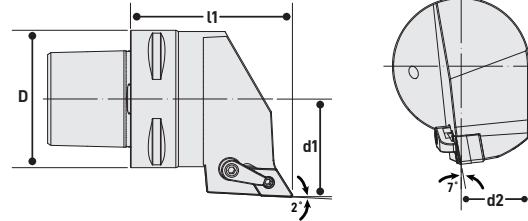

## C6 MDJN

Part No.	Description	l1	D	d1	d2	Insert	Clamp	Shim	Screw	Lock Pin
143.476.15L.075	C6 - MDJNL-EX15	75mm	63mm	45mm	31mm	DN_43_	MC622	DMS442	MS630	MLP46L-A
143.476.15R.075	C6 - MDJNR-EX15	75mm	63mm	45mm	31mm	DN_43_	MC622	DMS442	MS630	MLP46L-A

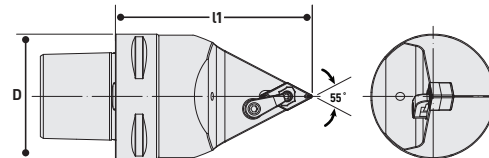

## C6 MDNN

Part No.	Description	l1	D	Insert	Clamp	Shim	Screw	Lock Pin
143.481.15N.100	C6 - MDNNN-H15	100mm	63mm	DN_43_	MC622	DMS442	MS625	MLP46L-A

## DNMG AND DNGG INSERTS FOR NEGATIVE TURNING AND BORING

Part No.	Description	Grade	Radius	Operation	Material
7607069	DNMG431-NN	LT10	.016	finishing	P-M-K-S-H
7608021	DNMG431-NN	LT1000	.016	finishing	P-M-K-S-H
7607073	DNMG432-NN	LT10	.031	finish-medium	P-M-K-S-H
7608026	DNMG432-NN	LT1000	.031	finish-medium	P-M-K-S-H
7608029	DNMG432-NX	LT1000	.031	general	P-M-K-S-H
7607077	DNMG433-NN	LT10	.047	medium-rough	P-M-K-S-H
7608031	DNMG433-NN	LT1000	.047	medium-rough	P-M-K-S-H

We recommend LT1000 grade inserts for maximum insert performance. LT1000 grade features an advanced PVD coating that is 14 microns thick and lasts 250% longer than other inserts.

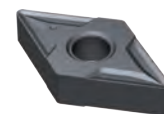

DNMG

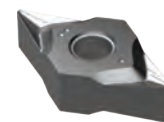

DNGG

\*CAPTO is a trademark of Sandvik AB and used for identification only.

P = steel, M = stainless, K = cast iron, S = high temp alloys, H = hardened material, N = aluminum & alloys



For turn/mill machines that accept "PSC" style toolholders.

## FEATURES

- High accuracy for best repeatability
- Turning, boring, threading and grooving

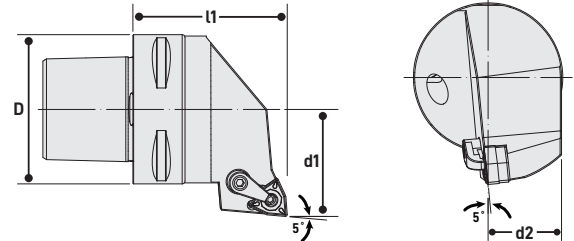

## C6 MWLN

Part No.	Description	l1	D	d1	d2	Insert	Clamp	Shim	Screw	Lock Pin
143.478.08L.065	C6 - MWLNL-DX08	65mm	63mm	45mm	31mm	WN_43_	MC620	TMS432	MS630	MLP46L-A
143.478.08R.065	C6 - MWLNR-DX08	65mm	63mm	45mm	31mm	WN_43_	MC620	TMS432	MS630	MLP46L-A

## WNMG INSERTS FOR NEGATIVE TURNING AND BORING

Part No.	Description	Grade	Radius	Operation	Material
4607257	WNMG431-NN	LT10	.016	finishing	P-M-K-S-H
4608011	WNMG431-NN	LT1000	.016	finishing	P-M-K-S-H
4607261	WNMG432-NN	LT10	.031	finish-medium	P-M-K-S-H
4608016	WNMG432-NN	LT1000	.031	finish-medium	P-M-K-S-H
4608023	WNMG432-NM	LT1000	.031	roughing	P-M-K-S-H
4601437	WNMG332-NR	LT10	.031	roughing	P-M-K-S-H
4608021	WNMG432-NX	LT1000	.031	general	P-M-K-S-H
4600076	WNMG432-WM	LT10	.031	finish-medium	P-M-K-S-H
4607265	WNMG433-NN	LT10	.047	medium-rough	P-M-K-S-H
4608026	WNMG433-NN	LT1000	.047	medium-rough	P-M-K-S-H

We recommend LT1000 grade inserts for maximum insert performance. LT1000 grade features an advanced PVD coating that is 14 microns thick and lasts 250% longer than other inserts.

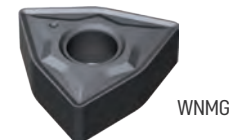

## WNMP INSERTS FOR NEGATIVE TURNING AND BORING

Part No.	Description	Grade	Radius	Operation	Material
4607277	WNMP432-NN	LT10	.031	finish-medium	P-M-K-S-H
4608031	WNMP432-NN	LT1000	.031	finish-medium	P-M-K-S-H

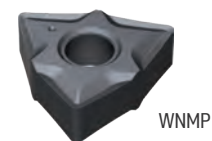

\*CAPTO is a trademark of Sandvik AB and used for identification only.

P = steel, M = stainless, K = cast iron, S = high temp alloys, H = hardened material, N = aluminum & alloys





For turn/mill machines that accept "PSC" style toolholders.

## FEATURES

- High accuracy for best repeatability
- Turning, boring, threading and grooving

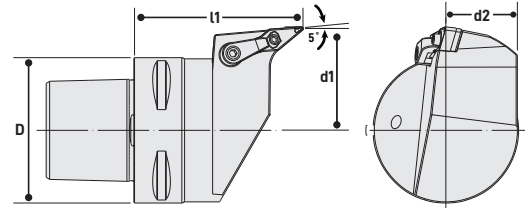

## C6 MVLN



Part No.	Description	l1	D	d1	d2	Insert	Clamp	Shim	Screw	Lock Pin
143.479.16L.075	C6 - MVLNL-EX16	75mm	63mm	45mm	31mm	VN_33_	MC622	VMS322	MS630	MLP34L-A
143.479.16R.075	C6 - MVLNR-EX16	75mm	63mm	45mm	31mm	VN_33_	MC622	VMS322	MS630	MLP34L-A

## VNMG INSERTS FOR NEGATIVE TURNING AND BORING

Part No.	Description	Grade	Radius	Operation	Material
8607241	VNMG331-NN	LT10	.016	finishing	P-M-K-S-H
8608011	VNMG331-NN	LT1000	.016	finishing	P-M-K-S-H
8607245	VNMG332-NN	LT10	.031	finish-medium	P-M-K-S-H
8608016	VNMG332-NN	LT1000	.031	finish-medium	P-M-K-S-H

We recommend LT1000 grade inserts for maximum insert performance. LT1000 grade features an advanced PVD coating that is 14 microns thick and lasts 250% longer than other inserts.



VNMG



VNGG

## VNGG INSERTS FOR ALUMINUM NEGATIVE TURNING AND BORING

Part No.	Description	Grade	Radius	Operation	Material
8607921	VNGG331-ALU	LT 05	.016	finishing	N
8607925	VNGG332-ALU	LT 05	.031	finish-medium	N

\*CAPTO is a trademark of Sandvik AB and used for identification only.

P = steel, M = stainless, K = cast iron, S = high temp alloys, H = hardened material, N = aluminum & alloys



# TECHNIKS TAPPING SOLUTIONS

QUALITY & PERFORMANCE GUARANTEED



## MICROFLOAT

Synchronous Tapping Holders

**INCREASE TAP LIFE 295%**

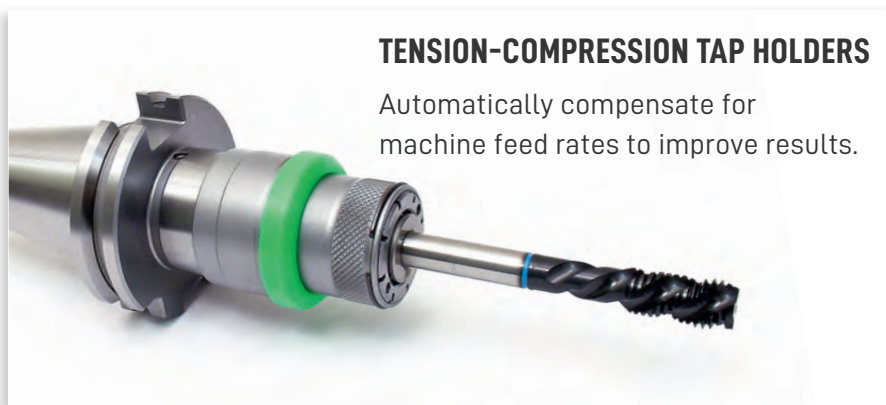

## TENSION-COMPRESSION TAP HOLDERS

Automatically compensate for machine feed rates to improve results.



## RIGID TAP CHUCKS

Easy to use and reliable tap holders for general tapping applications.



# MICROFLOAT SYNCHRONOUS TAPPING HOLDERS



MicroFLOAT synchronous tapping holders compensate for synchronization errors between the spindle rotation, feed-rate, and the thread-pitch that create damaging forces on your taps during a rigid tapping cycle.

Limiting these effects ultimately provides unmatched stability and repeatability to help you get the most out of your rigid tapping system.



**ELIMINATE TAP BREAKAGE**

**THIS GRAPH SHOWS HOW MICROFLOAT REDUCES STRESS ON THE TAP DURING TAPPING CYCLE.**

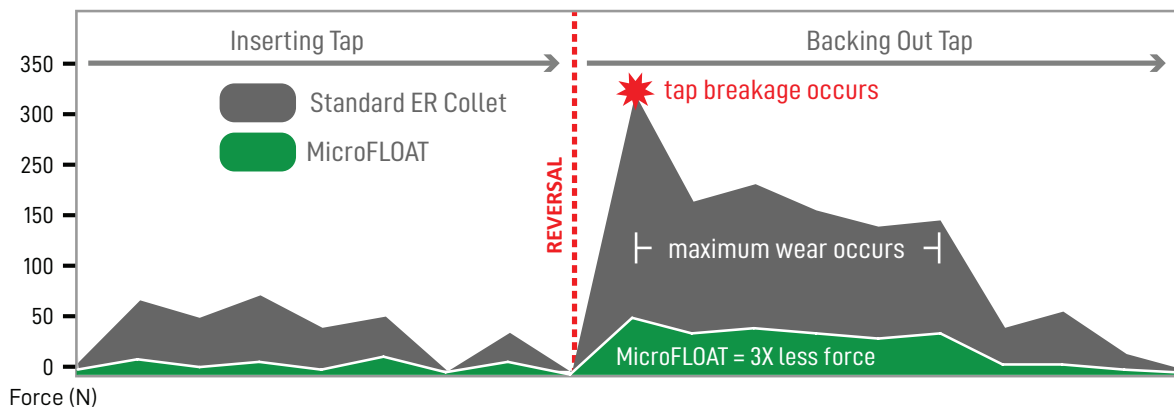

**SYNCHRONOUS FEED EASES THE TAP THROUGH THE WHOLE CYCLE, PREVENTING BREAKAGE.**



pg. 167



pg. 229



pg. 236



pg. 238

# MICROFLOAT SYNCHRONOUS TAPPING HOLDERS

MicroFLOAT's synchronous feed technology automatically compensates for inconsistencies between the spindle rotation, feed-rates, and thread-pitch to reduce unwanted axial forces on the tap to produce the truest possible threads and extend tap life.

Internal steel spring compensation allows 0.008" (.2mm) of compression and 0.040" (1mm) of tension, effectively compensating for synchronization errors, protecting the tap from excessive axial forces and breaking.

Because the tap follows the exact same path both in and out of the hole, optimum thread quality and maximum tap life is achieved.

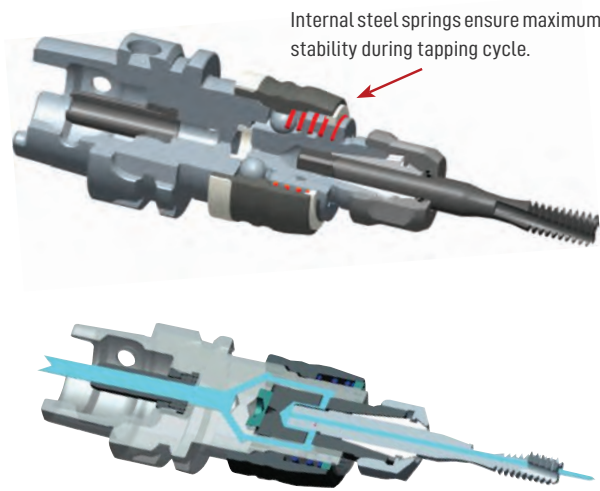

High-pressure (50 Bar) coolant through is standard.

## KEY TECHNOLOGY FEATURES

1. SYNCHRONOUS FEED
2. QUICK-CHANGE TAP ADAPTERS
3. MODULAR EXTENSIONS: UP TO 9"
4. COOLANT-THRU TECHNOLOGY

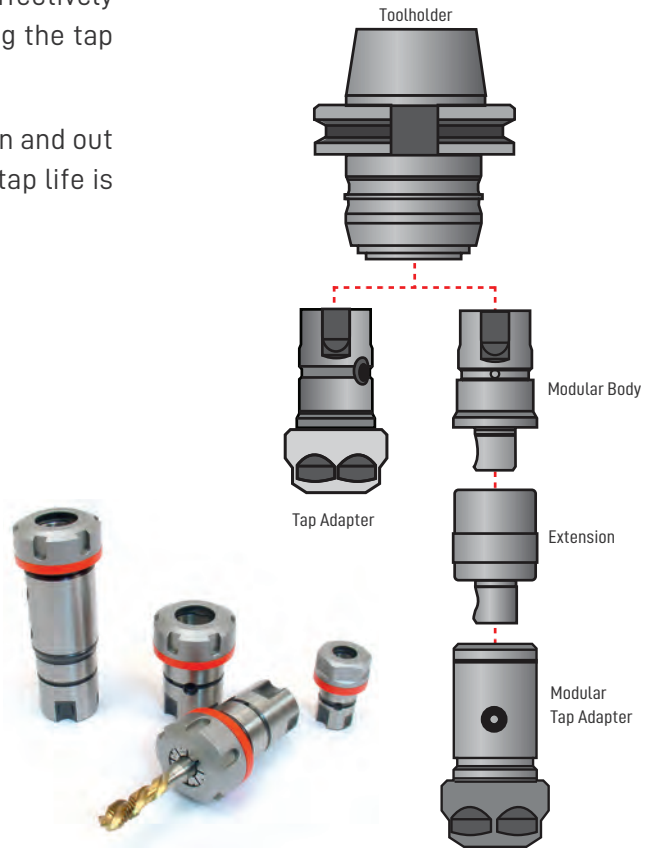

We compared the performance of a MicroFLOAT holder to a standard ER rigid tap holder. The MicroFLOAT holder yielded 337 more threaded holes per tap, a 295% improvement.

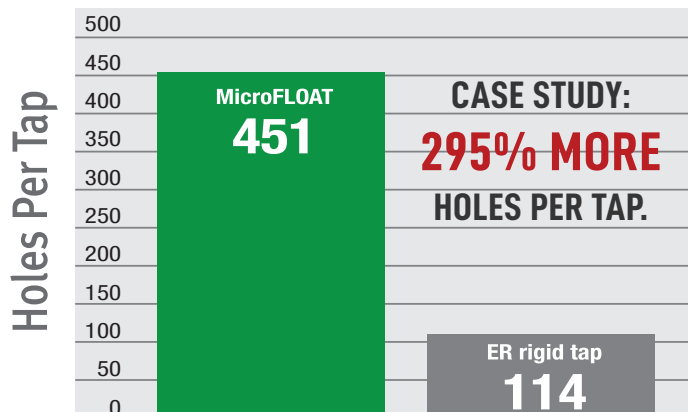

# MICROFLOAT SYNCHRONOUS TAPPING HOLDERS



## MICROFLOAT COMPONENTS

MicroFLOAT is an easy to use system that can be expanded to achieve lengths of 9" using modular extensions. Quick-change adapters makes tap replacement fast and easy.

### MICROFLOAT CAN BE CONFIGURED THREE WAYS:

1. Using a holder with a quick-change tap adapter
2. Holder with a modular body and modular tap adapter
3. Holder with a modular body, extensions, and modular tap adapter

## QUICK-CHANGE TAP ADAPTERS



## MODULAR EXTENSIONS ACHIEVE LENGTHS UP TO 9"

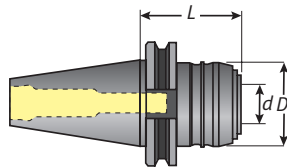

## MICROFLOAT TOOLHOLDERS

Part No.	Description	L	D	d	Collet Size
23400-40CAT	CAT40 holder #1	2.75"	1.7"	.79"	ER16
23600-40CAT	CAT40 holder #2	3.54"	2.36"	1.26"	ER25
23400-50CAT	CAT50 holder #1	2.75"	1.7"	.79"	ER16
23600-50CAT	CAT50 holder #2	3.54"	2.36"	1.26"	ER25
23400-30BT	BT30 holder #1	2.09"	1.7"	.79"	ER16
23400-40BT	BT40 holder #1	2.40"	1.7"	1.26"	ER16
23600-40BT	BT40 holder #2	3.22"	2.36"	1.26"	ER25
23400-H63A	HSK63A holder #1	2.52"	1.7"	.79"	ER16
23600-H63A	HSK63A holder #2	3.81"	2.36"	1.26"	ER25
23400-INC1	1" Straight Shank holder #1	1.3"	1.7"	.79"	ER16
23600-INC1	1" Straight Shank holder #2	2.13"	2.36"	1.26"	ER25

## QUICK-CHANGE TAP ADAPTER

ER16 fits taps up to 3/8"

ER25 fits taps up to 11/16"

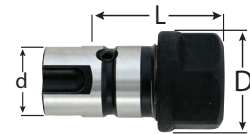

Part No.	Description	L	D	d
23410-ER16	ER16 tap adapter #1	1.46"	1.10"	.79"
23610-ER25	ER25 tap adapter #2	2.05"	1.65"	1.27"

## MODULAR BODY

Part No.	Description	L	D	d
23411-MOD	Modular Body #1	.20"	.91"	.79"
23611-MOD	Modular Body #2	.28"	1.38"	1.26"



## MODULAR EXTENSIONS

Part No.	Description	L	D	Chuck
42150-25	1" Mod. Extension #1	.98"	.91"	23400-..
42150-50	2" Mod. Extension #1	1.97"	.91"	23400-..
42250-50	2" Mod. Extension #2	1.97"	1.38"	23600-..
42250-100	4" Mod. Extension #2	3.94"	1.38"	23600-..

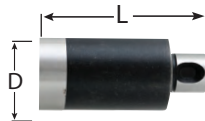

## ER MODULAR TAP ADAPTERS

Part No.	Description	L	D	d
42147-ER16	ER16 Mod. Adapter #1	1.97"	1.10"	.91"
42247-ER25	ER25 Mod. Adapter #2	3.11"	1.65"	1.38"

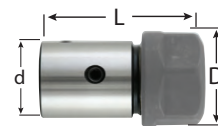





pg. 167



pg. 229



pg. 236



pg. 238

# RIGID TAP COLLETS FOR MICROFLOAT



## FEATURES

- Square drive prevents spinning the tap
- High-carbon steel, heat treated for long life
- Precision ground and polished

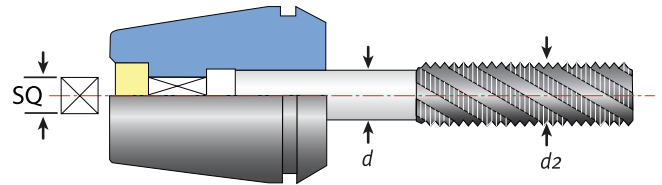

## ER16 / ER25 RIGID TAP COLLETS INCH

Part No.	Size	d	SQ	Tap Size (d2)
05320-141	ER16	.141"	.110"	1/8" or #6
05320-168	ER16	.168"	.131"	5/32" or #8
05320-194	ER16	.194"	.152"	3/16" or #10
05320-220	ER16	.220"	.165"	7/32" or #12
05320-255	ER16	.255"	.191"	1/4"
05320-318	ER16	.318"	.238"	5/16"
05320-323	ER16	.323"	.242"	7/16"
05320-367	ER16	.367"	.275"	1/2"
05320-381	ER16	.381"	.286"	3/8"
05510-141	ER25	.141"	.110"	1/8" or #6
05510-168	ER25	.168"	.131"	5/32" or #8
05510-194	ER25	.194"	.152"	3/16" or #10
05510-220	ER25	.220"	.165"	7/32" or #12
05510-255	ER25	.255"	.191"	1/4"
05510-318	ER25	.318"	.238"	5/16"
05510-323	ER25	.323"	.242"	7/16"
05510-367	ER25	.367"	.275"	1/2"
05510-381	ER25	.381"	.286"	3/8"
05510-429	ER25	.429"	.322"	9/16"
05510-437	ER25	.437"	.328"	1/8" NPT
05510-480	ER25	.480"	.360"	5/8"
05510-542	ER25	.542"	.406"	11/16"

## ER16 / ER25 RIGID TAP COLLETS METRIC

Part No.	Size	d	SQ	Tap Size (d2)
05326	ER16	2.8	2.1	M4
05330	ER16	3.5	2.7	M3
05336	ER16	4.5	3.4	M4
05342	ER16	6	4.9	M5/M6
05350	ER16	8	6.2	M8
05352	ER16	8.5	6.5	M12
05354	ER16	9	7	M12
05356	ER16	10	8	M10
05371	ER16	6	4.5	M6
05385	ER16	6.2	5	M8
05526	ER25	4.5	3.4	M4
05534	ER25	6	4.9	M5/M6
05540	ER25	7	5.5	M10
05542	ER25	8	6.2	M8
05548	ER25	9	7	M12
05550	ER25	10	8	M10
05554	ER25	11	9	M14
05558	ER25	12	9	M16







pg. 167



pg. 229



pg. 236



pg. 238



## FEATURES

- Adjustable compression helps start difficult taps
- Taper ground to AT3 accuracy or better
- Quick-Change Style

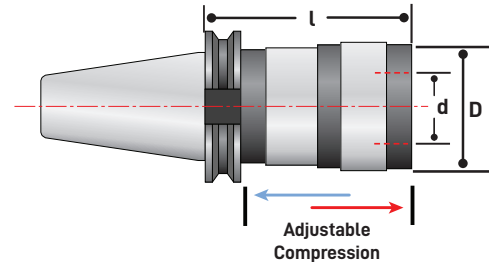

## CAT TENSION / COMPRESSION TAP HOLDERS

Part No.	Description	d	D	l	Size	Tap Capacity	Compensation	
							Tension	Compression
32400/40CAT	CAT40 T/C Holder, Size 1	.748"	1.5"	2.36"	1	0 – 9/16"	.35"	.35"
32400/50CAT	CAT50 T/C Holder, Size 1	.748"	1.5"	2.44"	1	0 – 9/16"	.35"	.35"
32600/40CAT	CAT40 T/C Holder, Size 2	1.220"	2.17"	3.94"	2	5/16 – 7/8"	.59"	.59"
32600/50CAT	CAT50 T/C Holder, Size 2	1.220"	2.17"	3.27"	2	5/16 – 7/8"	.59"	.59"
32800/40CAT	CAT40 T/C Holder, Size 3	1.890"	3.11"	5.43"	3	1/2 – 1-3/8"	.94"	.94"
32800/50CAT	CAT50 T/C Holder, Size 3	1.890"	3.11"	5.24"	3	1/2 – 1-3/8"	.94"	.94"
32900/40CAT	CAT40 T/C Holder, Size 4	2.362"	3.86"	6.06"	4	1-7/16 – 1-7/8"	1.02"	1.02"
32900/50CAT	CAT50 T/C Holder, Size 4	2.362"	3.86"	5.79"	4	1-7/16 – 1-7/8"	1.02"	1.02"

## BT TENSION / COMPRESSION TAP HOLDERS

Part No.	Description	d	D	l	Size	Tap Capacity	Compensation	
							Tension	Compression
32400/30BT	BT30 T/C Holder, Size 1	.748"	1.5"	2.48"	1	0 – 9/16"	.35"	.35"
32400/40BT	BT40 T/C Holder, Size 1	.748"	1.5"	2.68"	1	0 – 9/16"	.35"	.35"
32400/50BT	BT50 T/C Holder, Size 1	.748"	1.5"	3.15"	1	0 – 9/16"	.35"	.35"
32600/30BT	BT30 T/C Holder, Size 2	1.220"	2.17"	3.78"	2	5/16 – 7/8"	.59"	.59"
32600/40BT	BT40 T/C Holder, Size 2	1.220"	2.17"	3.66"	2	5/16 – 7/8"	.59"	.59"
32600/50BT	BT50 T/C Holder, Size 2	1.220"	2.17"	4.02"	2	5/16 – 7/8"	.59"	.59"
32800/40BT	BT40 T/C Holder, Size 3	1.890"	3.11"	5.43"	3	1/2 – 1-3/8"	.94"	.94"
32800/50BT	BT50 T/C Holder, Size 3	1.890"	3.11"	5.31"	3	1/2 – 1-3/8"	.94"	.94"
32900/40BT	BT40 T/C Holder, Size 4	2.362"	3.86"	6.18"	4	1-7/16 – 1-7/8"	1.02"	1.02"
32900/50BT	BT50 T/C Holder, Size 4	2.362"	3.86"	5.79"	4	1-7/16 – 1-7/8"	1.02"	1.02"



pg. 167



pg. 229



pg. 236



pg. 238

# TENSION/COMPRESSION TAP HOLDERS



## FEATURES

- Adjustable compression helps start difficult taps
- Quick-Change Style

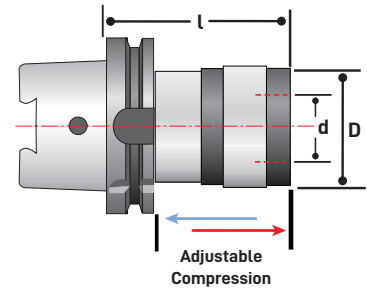

## HSK-A TENSION / COMPRESSION TAP HOLDERS

Part No.	Description	d	D	l	Size	Tap Capacity	Compensation	
							Tension	Compression
34400/H40A	HSK40A T/C Holder, Size 1	.748"	1.5"	3.14"	1	0 – 9/16"	.295"	.295"
34400/H50A	HSK50A T/C Holder, Size 1	.748"	1.5"	2.83"	1	0 – 9/16"	.295"	.295"
34400/H63A	HSK63A T/C Holder, Size 1	.748"	1.5"	2.83"	1	0 – 9/16"	.295"	.295"
34400/H100A	HSK100A T/C Holder, Size 1	.748"	1.5"	3.14"	1	0 – 9/16"	.295"	.295"
34600/H50A	HSK50A T/C Holder, Size 2	1.22"	2.17"	4.33"	2	5/16 – 7/8"	.393"	.393"
34600/H63A	HSK63A T/C Holder, Size 2	1.22"	2.17"	4.33"	2	5/16 – 7/8"	.393"	.393"
34600/H100A	HSK100A T/C Holder, Size 2	1.22"	2.17"	3.94"	2	5/16 – 7/8"	.393"	.393"

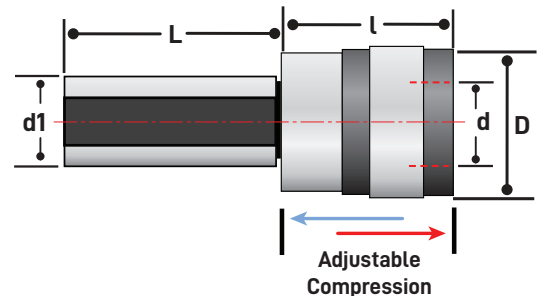

## STRAIGHT SHANK TAPPING CHUCKS

Part No.	Description	D1	D	l	L	Tap Capacity	Compensation	
							Tension	Compression
32400/INC1	1" shank T/C Holder, Size 1	1"	1.5"	1.76"	1.95"	0 – 9/16"	.35"	.35"
32600/INC1	1" shank T/C Holder, Size 2	1"	2.17"	2.52"	2"	5/16 – 7/8"	.59"	.59"
32600/INC1-1/2	1 1/2" shank T/C Holder, Size 2	1.50"	2.17"	2.52"	3.50"	5/16 – 7/8"	.59"	.59"
32800/INC1-1/2	1 1/2" shank T/C Holder, Size 3	1.50"	3.38"	3.85"	3.50"	1/2 – 1 3/8"	.94"	.94"





## FEATURES

- Taper ground to AT3 accuracy or better
- Quick-Change Style

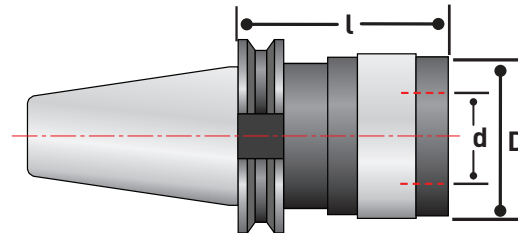

## CAT RIGID TAP HOLDERS

Part No.	Description	l	D	d	Size	Tap Capacity
21480/40CAT	CAT40 Rigid Tap Holder, Size 1	2.59"	1.31"	.748"	1	0 – 9/16"
21480/50CAT	CAT50 Rigid Tap Holder, Size 1	2.95"	1.31"	.748"	1	0 – 9/16"
21680/40CAT	CAT40 Rigid Tap Holder, Size 2	3.23"	1.97"	1.22"	2	5/16 – 7/8"
21680/50CAT	CAT50 Rigid Tap Holder, Size 2	3.86"	1.97"	1.22"	2	5/16 – 7/8"
21880/40CAT	CAT40 Rigid Tap Holder, Size 3	4.80"	2.83"	1.89"	3	1/2 – 1 3/8"
21880/50CAT	CAT50 Rigid Tap Holder, Size 3	4.80"	2.83"	1.89"	3	1/2 – 1-3/8"

## BT RIGID TAP HOLDERS

Part No.	Description	l	D	d	Size	Tap Capacity
21480/30BT	BT30 Rigid Tap Holder, Size 1	2.80"	1.31"	.748"	1	0 – 9/16"
21480/40BT	BT40 Rigid Tap Holder, Size 1	2.63"	1.31"	.748"	1	0 – 9/16"
21480/50BT	BT50 Rigid Tap Holder, Size 1	3.07"	1.31"	.748"	1	0 – 9/16"
21680/30BT	BT30 Rigid Tap Holder, Size 2	3.70"	1.97"	1.22"	2	5/16 – 7/8"
21680/40BT	BT40 Rigid Tap Holder, Size 2	3.54"	1.97"	1.22"	2	5/16 – 7/8"
21680/50BT	BT50 Rigid Tap Holder, Size 2	3.97"	1.97"	1.22"	2	5/16 – 7/8"
21880/40BT	BT40 Rigid Tap Holder, Size 3	4.61"	2.83"	1.89"	3	1/2 – 1 3/8"
21880/50BT	BT50 Rigid Tap Holder, Size 3	4.80"	2.83"	1.89"	3	1/2 – 1 3/8"



pg. 167



pg. 229



pg. 236



pg. 238



## FEATURES

- Quick-Change Style

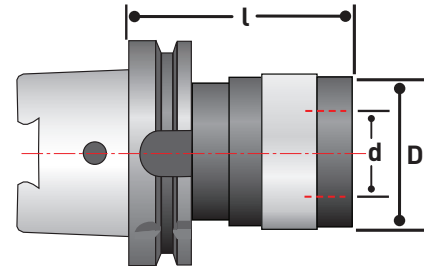

## HSK RIGID TAP HOLDERS

Part No.	Description	l	D	d	Size	Tap Capacity
21480/H50A	HSK50A Rigid Tap Holder, Size 1	2.30"	1.31"	.748"	1	0 - 9/16"
21480/H63A	HSK63A Rigid Tap Holder, Size 1	2.32"	1.31"	.748"	1	0 - 9/16"
21480/H100A	HSK100A Rigid Tap Holder, Size 1	2.95"	1.31"	.748"	1	0 - 9/16"
21680/H50A	HSK50A Rigid Tap Holder, Size 2	3.23"	1.97"	1.22"	2	5/16 - 7/8"
21680/H63A	HSK63A Rigid Tap Holder, Size 2	3.23"	1.97"	1.22"	2	5/16 - 7/8"
21680/H100A	HSK100A Rigid Tap Holder, Size 2	3.86"	1.97"	1.22"	2	5/16 - 7/8"
21880/H63A	HSK63A Rigid Tap Holder, Size 3	4.80"	2.83"	1.89"	3	1/2 - 1 3/8"
21880/H100A	HSK100A Rigid Tap Holder, Size 3	4.80"	2.83"	1.89"	3	1/2 - 1 3/8"

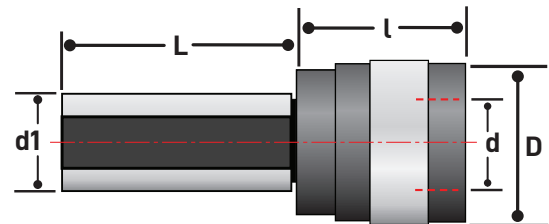

## STRAIGHT SHANK RIGID TAP HOLDERS

Part No.	Description	d1	L	l	D	d	Tap Capacity
21480/INC1	1" shank, Rigid Tap Holder, Size 1	1"	1.95"	1.60"	1.31"	.748"	0 - 9/16"
21680/INC1	1" shank, Rigid Tap Holder, Size 2	1"	2"	2.50"	1.97"	1.22"	3/8 - 7/8"
21880/INC1-1/2	1 1/2" shank, Rigid Tap Holder, Size 3	1.50"	3.50"	3.44"	2.83"	1.89"	1/2 - 1 3/8"



# ANSI RIGID TAP COLLETS



pg. 167



pg. 229



pg. 236



pg. 238



## FEATURES

- Change worn taps in seconds
- Quick-Change Style

## DIMENSIONS

Dimensions	A	B	C	D	E
Size 1	.75"	.85"	.28"	1.18"	.39"
Size 2	1.22"	1.38"	.43"	1.81"	.75"
Size 3	1.89"	2.19"	.55"	2.68"	1.18"
Size 4	2.36"	2.48"	1.65"	3.27"	1.14"

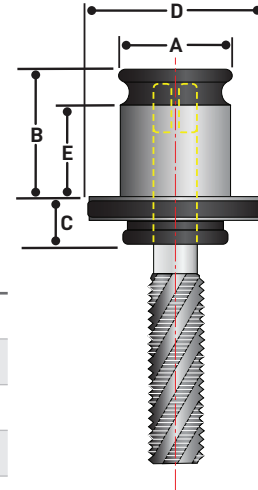

## COLLET SETS

Part No.	Description
19/11-SET	Size 1, 11 pcs. (0-6" thru 9/16" & 1/8" NPT)
31/12-SET	Size 2, 13 pcs. (5/16" thru 1/2" NPT)
48/13-SET	Size 3, 16 pcs. (1/2" thru 1" NPT)

## ANSI RIGID TAP COLLETS

ANSI	Metric Tap / ANSI Shank	Shank	SQ	Size 1	Size 2	Size 3	Size 4
0-6"	M1.6-M3.5	.141"	.110"	19/11-4036			
8, 5/32"	M4	.168"	.131"	19/11-4041			
10, 3/16"	M4.5, M5	.194"	.152"	19/11-4048			
12, 7/32"		.220"	.165"	19/11-4054			
1/4"	M6, M6.3	.255"	.191"	19/11-4063			
5/16"	M7, M8	.318"	.238"	19/11-4079	31/12-4079		
3/8"	M10	.381"	.286"	19/11-4095	31/12-4095		
7/16"	M11	.323"	.242"	19/11-4111	31/12-4111		
1/2"	M12, M12.5	.367"	.275"	19/11-4127	31/12-4127	48/13-4127	
9/16"	M14	.429"	.322"	19/11-4142	31/12-4142	48/13-4142	
5/8"	M16	.480"	.360"		31/12-4158	48/13-4158	
11/16"	M18	.542"	.406"		31/12-4174	48/13-4174	
3/4"		.590"	.442"		31/12-4190C	48/13-4190	
13/16"	M20	.652"	.489"		31/12-4206C	48/13-4206	
7/8"	M22	.697"	.523"		31/12-4222C	48/13-4222	
15/16"	M24	.760"	.570"			48/13-4238	
1"	M25	.800"	.600"			48/13-4254	
1 1/8, 1 1/16"	M27	.896"	.672"			48/13-4286	
1 1/4, 1 3/16"	M30	1.021"	.766"			48/13-4317	
1 3/8, 1 5/16"	M33	1.108"	.831"			48/13-4349	
1 1/2, 1 7/16"	M36	1.233"	.925"				60/14-4381C
1 5/8"	M39	1.305"	.979"				60/14-4412C
1 3/4"	M42	1.430"	1.072"				60/14-4444C
1 7/8"		1.520"	1.139"				60/14-4476C
1/8" NPT		.437"	.328"	19/11-4097			
1/4" NPT		.562"	.421"		31/12-4131C		
3/8" NPT		.700"	.531"		31/12-4166C	48/13-4166C	
1/2" NPT		.687"	.515"		31/12-4209C	48/13-4209C	
3/4" NPT		.906"	.678"			48/13-4264C	
1" NPT		1.125"	.843"			48/13-4332C	



pg. 167



pg. 229



pg. 236



pg. 238

# ANSI CLUTCH DRIVE TAP COLLETS



## COLLET SET

Part No.	Description
48/3-SET	Size 3, 16 pcs. (1/2" thru 1" NPT)
19/1-SET	Size 1, 11 pcs. (0.141" thru 1/8" NPT)
31/2-SET	Size 2, 13 pcs. (5/16" thru 1/2" NPT)

## FEATURES

- Prevents broken taps
- Automatically stops spinning when bottom is reached
- Change worn taps in seconds

## DIMENSIONS

Dimensions	A	B	C	D	E
Size 0	.51"	.77"	.83"	.91"	.24"
Size 1	.75"	.85"	.98"	1.26"	.31"
Size 2	1.22"	1.38"	1.34"	1.97"	.16"
Size 3	1.89"	2.19"	1.77"	2.83"	.04"

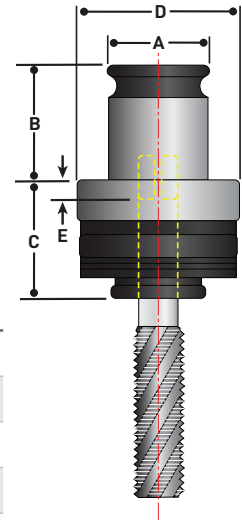

## ANSI CLUTCH DRIVE TAP COLLETS

ANSI	Metric Tap / ANSI Shank	Shank	SQ	Size 0	Size 1	Size 2	Size 3
0-6"	M1.6-M3.5	.141"	.110"	13/0-4036	19/1-4036		
8, 5/32"	M4	.168"	.131"	13/0-4041	19/1-4041		
10, 3/16"	M4.5, M5	.194"	.152"	13/0-4048	19/1-4048		
12, 7/32"		.220"	.165"	13/0-4054	19/1-4054		
1/4"	M6, M6.3	.255"	.191"	13/0-4063	19/1-4063		
5/16"	M7, M8	.318"	.238"		19/1-4079	31/2-4079	
3/8"	M10	.381"	.286"		19/1-4095	31/2-4095	
7/16"	M11	.323"	.242"		19/1-4111	31/2-4111	
1/2"	M12, M12.5	.367"	.275"		19/1-4127	31/2-4127	48/3-4127
9/16"	M14	.429"	.322"		19/1-4142	31/2-4142	48/3-4142
5/8"	M16	.480"	.360"			31/2-4158	48/3-4158
11/16"	M18	.542"	.406"			31/2-4174	48/3-4174
3/4"		.590"	.442"			31/2-4190	48/3-4190
13/16"	M20	.652"	.489"			31/2-4206	48/3-4206
7/8"	M22	.697"	.523"			31/2-4222	48/3-4222
15/16"	M24	.760"	.570"				48/3-4238
1"	M25	.800"	.600"				48/3-4254
1 1/8, 1 1/16"	M27	.896"	.672"				48/3-4286
1 1/4, 1 3/16"	M30	1.021"	.766"				48/3-4317
1 3/8, 1 5/16"	M33	1.108"	.831"				48/3-4349
1/8" NPT		.437"	.328"		19/1 - 4097		
1/4" NPT		.562"	.421"			31/2-4131C	
3/8" NPT		.700"	.531"			31/2-4166C	48/3-4166C
1/2" NPT		.687"	.515"			31/2-4209C	48/3-4209C
3/4" NPT		.906"	.678"				48/3-4264C
1" NPT		1.125"	.843"				48/3-4332C

**Note:** Metric tap collets available on request. Please verify shank diameter when ordering metric tap collets.





## RECOMMENDED COLLET NUT & RETENTION KNOB TIGHTENING TORQUE

Collet	Nut Type	Collets I.D. OVER 1/16" (2mm)	Collets I.D. UNDER 1/16" (2mm)	Order Torque Wrench Adapter
ER11	Mini	12 ft/lbs	10 ft/lbs	04576
ER11	Hex	17 ft/lbs	14 ft/lbs	04581
ER16	Mini	20 ft/lbs	16 ft/lbs	04578
ER16	Slotted	42 ft/lbs	30 ft/lbs	04580-16
ER16	Hex	42 ft/lbs	30 ft/lbs	04601-16
ER20	Mini	22 ft/lbs	18 ft/lbs	04578
ER20	Slotted	59 ft/lbs	24 ft/lbs	04580-20
ER20	Hex	59 ft/lbs	24 ft/lbs	04602-20
ER25	Mini	28 ft/lbs	28 ft/lbs	04587
ER25	Slotted	77 ft/lbs	77 ft/lbs	04603-25
ER32	Slotted	100 ft/lbs	100 ft/lbs	04604-32
ER40	Slotted	130 ft/lbs	130 ft/lbs	04605-40
SY0Z 25/TG100	Hook	95 ft/lbs	95 ft/lbs	03690-25
TG75	Hex	90 ft/lbs	90 ft/lbs	04604-32

Always tighten retention knobs to exact specification or damage to tooling or bodily harm may occur.

Retention Knobs	Wrench Flats	Drive	Torque	Order Socket
BT30 Taper	0.535"	1/4"	36 ft/lbs	PSS-30BT
ISO 30 Taper	0.535"	3/8"	36 ft/lbs	PSS-30ISO
Any 40 Taper	0.750"	3/8"	76 ft/lbs	PSS-40
BT50 Taper	1.187"	1/2"	99 ft/lbs	PSC-50
CAT50 Taper	1.250"	1/2"	99 ft/lbs	PSC-50

\*\*Always use a torque wrench and tightening stand when tightening collet nuts and retention knobs. Overtightening collet nuts will cause premature damage to collets and increase run-out.

### DIRECTIONS

- Snap collet into nut.
- Insert cutting tool into collet. Make sure shank extends to the bottom of the collet.
- Hand tighten collet nut assembly into toolholder.
- Insert toolholder assembly into tightening fixture and secure it.
- Tighten collet nut to recommended torque using a torque wrench and adapter.

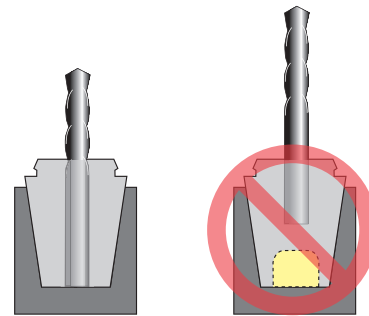

For maximum holding power fill the collet all the way with the tool shank (left) and use a PowerCOAT nut.

# TECHNIKS MODULAR BORING SOLUTIONS

MODULAR BORING SYSTEMS FOR SMALL TO LARGE DIAMETER BORING



## BOHRSTAR BORING KITS

**RANGE: FROM .314" TO 8.27"**

Choose BohrSTAR boring kits for an easy-to-use boring system, without the expense of dedicated boring tools.

see page 176



## ULTRAFINE FINISH HEADS

**75° & 90° HEADS AVAILABLE**

UltraFINE finish heads feature an 11° relief angle that provides an ultra-smooth finish, reducing the need for extra operations.

see page 200

## MACROBOHR LARGE HOLE BORING SYSTEM

**RANGE: FROM 8.661" TO 40.157"**

The MacroBOHR boring system is a lightweight line of tools optimized for large diameter boring.

see page 219



# BOHRSTAR 43 KIT -TRIANGULAR INSERTS



## INCLUDES TRIANGULAR INSERTS:

- 2 Pcs. TCMT 1.21\_
- 3 Pcs. TCMT 1.81\_

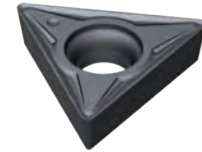

TCMT

## RANGE: 0.314" TO 1.692"

BohrSTAR kits are designed for maximum performance and ease-of-use (no spacers or complicated set-ups). Our boring tools out perform all others when it comes to accuracy, rigidity, and repeatability.

Our exclusive, modular coupling system features two tapered locking screws that provide maximum rigidity between the boring head and the toolholder to increase accuracy. All connections are easily made using the tools provided.

Kit Part No.	Description	Range
6991215	BS-54-KIT-TC-8-43	0.314" - 1.692"

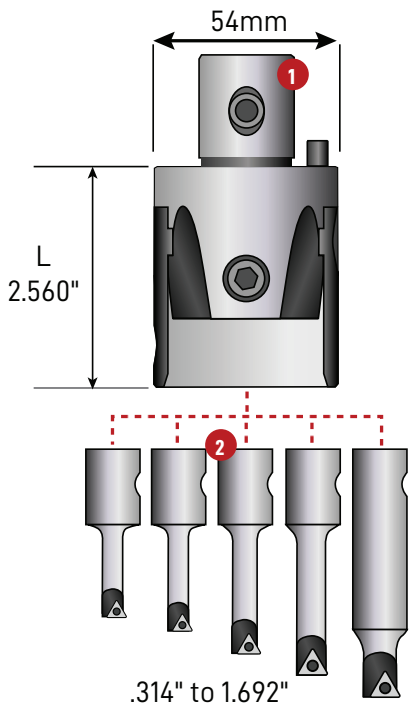

## BOHRSTAR 43 KIT INCLUDES THESE COMPONENTS

Part No.	Description	Length
<b>1</b> 6951234	BS-54-16-W head	2.560"
6943333	BS-06-16-T01 6mm bar	.984"
6943334	BS-08-16-T01 8mm bar	1.378"
<b>2</b> 6943335	BS-10-16-T02 10mm bar	1.772"
6943336	BS-12-16-T02 12mm bar	2.244"
6943337	BS-16-16-T02 16mm bar	2.874"
6962233	H3 hex wrench	-
<b>3</b> 6962235	H5 hex wrench	-
6962236	H6 hex wrench	-
6972236	T6 Torx wrench	-
<b>4</b> 6972237	T7 Torx wrench	-

## KIT BORING BAR & INSERT SPECIFICATIONS

Boring Bar Part No.	Description	Bore Range		L	Insert	Insert Screw	Wrench
		Min	Max				
6943333	BS-06-16-T01	.314"	1.181"	.984"	TCMT 1.21_	6811220	9355111
6943334	BS-08-16-T01	.394"	1.260"	1.378"	TCMT 1.21_	6811235	9355111
6943335	BS-10-16-T02	.512"	1.378"	1.772"	TCMT 1.815_	6811250	9355222
6943336	BS-12-16-T02	.630"	1.496"	2.244"	TCMT 1.815_	6811250	9355222
6943337	BS-16-16-T02	.787"	1.692"	2.874"	TCMT 1.815_	6811250	9355222



pg. 204



pg. 206



pg. 216



pg. 229

# BOHRSTAR 43 KIT - RHOMBIC INSERTS



## INCLUDES RHOMBIC INSERTS:

- 1 Pc. EPMT 1.5\_
- 3 Pcs. CCMT 21.5\_
- 1 Pc. CCMT 32.5\_



CCMT

**RANGE: 0.314" TO 1.692"**

BohrSTAR kits are designed for maximum performance and ease-of-use (no spacers or complicated set-ups). Our boring tools out perform all others when it comes to accuracy, rigidity, and repeatability.

Our exclusive, modular coupling system features two tapered locking screws that provide maximum rigidity between the boring head and the toolholder to increase accuracy. All connections are easily made using the tools provided.

Kit Part No.	Description	Range
6991210	BS-54-KIT-RC-8-43	0.314" - 1.692"

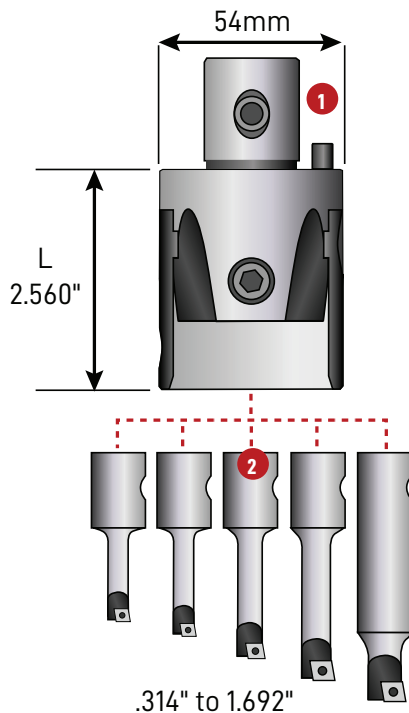

## BOHRSTAR 43 KIT INCLUDES THESE COMPONENTS

	Part No.	Description	Length
<b>1</b>	6951234	BS-54-16-W head	2.560"
	6942234	BS-06-16-R02 6mm bar	.984"
	6942235	BS-08-16-R03 8mm bar	1.378"
<b>2</b>	6942236	BS-10-16-R03 10mm bar	1.772"
	6942237	BS-12-16-R03 12mm bar	2.244"
	6942238	BS-16-16-R04 16mm bar	2.874"
	6962233	H3 hex wrench	-
<b>3</b>	6962235	H5 hex wrench	-
	6962236	H6 hex wrench	-
	6972238	T8 Torx wrench	-
<b>4</b>	6972237	T7 Torx wrench	-
<b>5</b>	6972215	T15 Torx wrench	-

## KIT BORING BAR & INSERT SPECIFICATIONS

Boring Bar Part No.	Description	Bore Range		L	Insert	Insert Screw	Wrench
		Min	Max				
6942234	BS-06-16-R02	.314"	1.181"	.984"	EPMT 1.53_	6811220	9355222
6942235	BS-08-16-R03	.394"	1.260"	1.378"	CCMT 21.5_	6811235	9355333
6942236	BS-10-16-R03	.512"	1.378"	1.772"	CCMT 21.5_	6811250	9355333
6942237	BS-12-16-R03	.630"	1.496"	2.244"	CCMT 21.5_	6811250	9355333
6942238	BS-16-16-R04	.787"	1.692"	2.874"	CCMT 32.5_	6811260	9355555

# BOHRSTAR 100 KIT - TRIANGULAR INSERTS



## INCLUDES TRIANGULAR INSERTS:

- 2 Pcs. TCMT 1.21\_
- 3 Pcs. TCMT 1.81\_
- 2 Pcs. TCMT 32.5\_

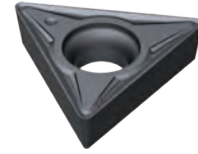

TCMT

**RANGE: 0.314" TO 3.94"**

Kit Part No.	Description	Range
6991235	BS-54-KIT-TC-8-100	0.314" – 3.94"

## BOHRSTAR 100 KIT INCLUDES THESE COMPONENTS

Part No.	Description	Length
<b>1</b> 6951234	BS-54-16-W head	2.560"
6943333	BS-06-16-T01 6mm bar	.984"
6943334	BS-08-16-T01 8mm bar	1.378"
<b>2</b> 6943335	BS-10-16-T02 10mm bar	1.772"
6943336	BS-12-16-T02 12mm bar	2.244"
6943337	BS-16-16-T02 16mm bar	2.874"
<b>3</b> 6943338	BS-34-16-T04 34mm bar	3.228"
<b>4</b> 6922243	BS-2CT-T04 cartridge	
<b>5</b> 6921239	BS-16-M10 location sleeve	
6962233	H3 hex wrench	
<b>6</b> 6962235	H5 hex wrench	
6962236	H6 hex wrench	
6962238	H8 hex wrench	
6972236	T6 Torx wrench	
<b>7</b> 6972237	T7 Torx wrench	
6972215	T15 Torx wrench	
<b>8</b> 6921241	CS-10-25 cartridge screw	

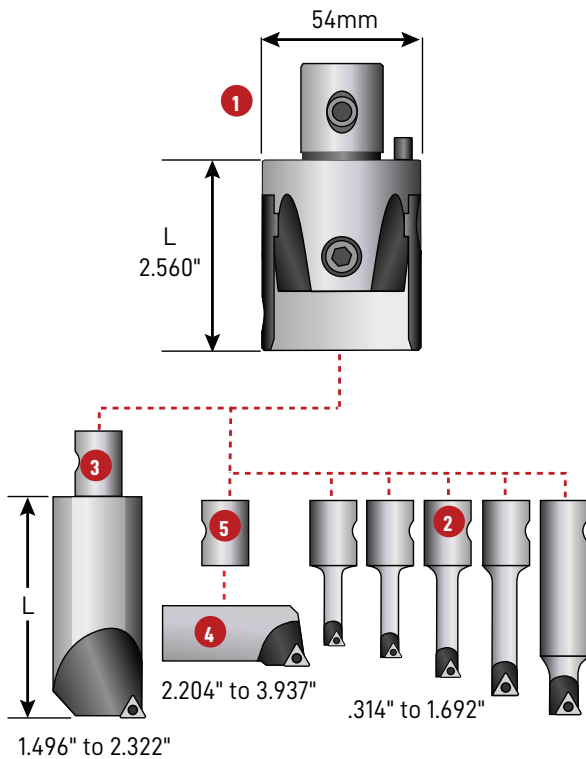

## KIT BORING BAR & INSERT SPECIFICATIONS

Boring Bar Part No.	Description	Bore Range			L	Insert	Insert Screw	Wrench
		Min	Max					
6943333	BS-06-16-T01	.314"	1.181"	.984"	TCMT 1.21_	6811220	9355111	
6943334	BS-08-16-T01	.394"	1.260"	1.378"	TCMT 1.21_	6811235	9355111	
6943335	BS-10-16-T02	.512"	1.378"	1.772"	TCMT 1.81.5_	6811250	9355222	
6943336	BS-12-16-T02	.630"	1.496"	2.244"	TCMT 1.81.5_	6811250	9355222	
6943337	BS-16-16-T02	.787"	1.692"	2.874"	TCMT 1.81.5_	6811250	9355222	
6943338	BS-34-16-T04	1.496"	2.322"	3.228"	TCMT 32.5_	6811260	9355555	
6922243	BS-2CT-T04 cartridge	2.204"	3.937"	.787"	TCMT 32.5_	6811260	9355555	



# BOHRSTAR 100 KIT - RHOMBIC INSERTS



## INCLUDES RHOMBIC INSERTS:

- 1 Pc. EPMT 1.5\_
- 3 Pcs. CCMT 21.5\_
- 3 Pcs. CCMT 32.5\_

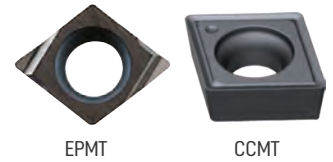

**RANGE: 0.314" TO 3.94"**

Kit Part No.	Description	Range
6991220	BS-54-KIT-RC-8-100	0.314" - 3.94"

## BOHRSTAR 100 KIT INCLUDES THESE COMPONENTS

Part No.	Description	Length
<b>1</b> 6951234	BS-54-16-W Head	2.560"
6942234	BS-06-16-R02 6mm bar	.984"
6942235	BS-08-16-R03 8mm bar	1.378"
<b>2</b> 6942236	BS-10-16-R03 10mm bar	1.772"
6942237	BS-12-16-R03 12mm bar	2.244"
6942238	BS-16-16-R04 16mm bar	2.874"
<b>3</b> 6942239	BS-34-16-R04 34mm bar	3.228"
<b>4</b> 6922243	BS-2CT-R04 Cartridge	
<b>5</b> 6921239	BS-16-M10 Location sleeve	
6962233	H3 hex wrench	
<b>6</b> 6962235	H5 hex wrench	
6962236	H6 hex wrench	
6962238	H8 hex wrench	
6972238	T8 Torx wrench	
<b>7</b> 6972237	T7 Torx wrench	
6972215	T15 Torx wrench	
<b>8</b> 6921241	CS-10-25 Cartridge screw	

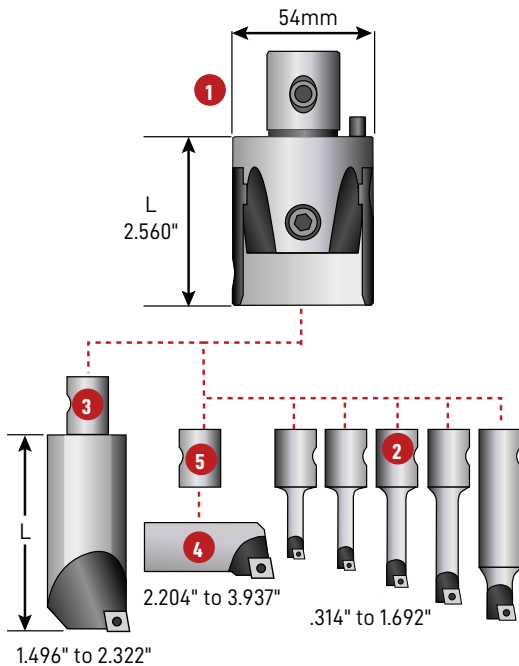

## KIT BORING BAR & INSERT SPECIFICATIONS

Boring Bar Part No.	Description	Bore Range		L	Insert	Insert Screw	Wrench
		Min	Max				
6942234	BS-06-16-R02	.314"	1.181"	.984"	EPMT 1.53_	6811220	9355222
6942235	BS-08-16-R03	.394"	1.260"	1.378"	CCMT 21.5_	6811235	9355333
6942236	BS-10-16-R03	.512"	1.378"	1.772"	CCMT 21.5_	6811250	9355333
6942237	BS-12-16-R03	.630"	1.496"	2.244"	CCMT 21.5_	6811250	9355333
6942238	BS-16-16-R04	.787"	1.692"	2.874"	CCMT 32.5_	6811260	9355555
6942239	BS-34-16-R04	1.496"	2.322"	3.228"	CCMT 32.5_	6811260	9355555
6922243	BS-2CT-R04 Cartridge	2.204"	3.937"	.787"	CCMT 32.5_	6811260	9355555



# BOHRSTAR 170 KIT - TRIANGULAR INSERTS

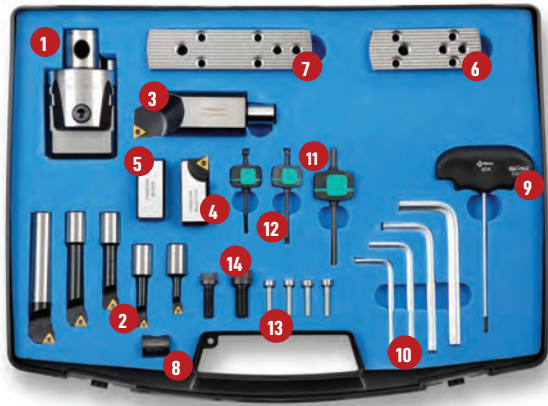

## INCLUDES TRIANGULAR INSERTS:

- 2 Pc. TCMT 1.21\_
- 3 Pcs. TCMT 1.81\_
- 2 Pcs. TCMT 32.5\_

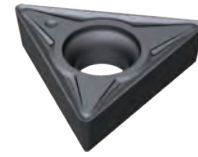

TCMT

**RANGE: .314" TO 6.69"**

Kit Part No.	Description	Range
6991250	BS-54-KIT-TC-8-170	0.314" – 6.69"

## BOHRSTAR 170 KIT INCLUDES THESE COMPONENTS

Part No.	Description	Length
<b>1</b> 6951234	BS-54-16-W Head	2.560"
6943333	BS-06-16-T01 6mm Bar	.984"
6943334	BS-08-16-T01 8mm Bar	1.378"
<b>2</b> 6943335	BS-10-16-T02 10mm Bar	1.772"
6943336	BS-12-16-T02 12mm Bar	2.244"
6943337	BS-16-16-T02 16mm Bar	2.874"
<b>3</b> 6943338	BS-34-16-T04 34mm Bar	3.228"
<b>4</b> 6922243	BS-2CT-T04 Cartridge	.787"
<b>5</b> 6921235	BS-2CW Counterweight	.728"
<b>6</b> 6921236	BS-SP-85-130 Small plate	.787"
<b>7</b> 6921237	BS-SP-125-170 Medium plate	.787"
<b>8</b> 6921239	BS-16-M10 Location sleeve	

Part No.	Description
<b>9</b> 6921243	A3 Adjusting key
6962234	H4 hex wrench
6962235	H5 hex wrench
<b>10</b> 6962236	H6 hex wrench
6962238	H8 hex wrench
6972237	T7 Torx wrench
<b>11</b> 6972238	T8 Torx wrench
6972215	T15 Torx wrench
<b>12</b> 6921240	D-27-21 Plate fixing screws
<b>13</b> 6921241	CS-10-25 Cartridge screw
<b>14</b> 6921242	CS-08-25 Counterweight screw

## KIT BORING BAR & INSERT SPECIFICATIONS

Boring Bar Part No.	Description	Bore Range		L	Insert	Insert Screw	Wrench
		Min	Max				
6943333	BS-06-16-T01	.314"	1.181"	.984"	TCMT 1.21_	6811220	9355111
6943334	BS-08-16-T01	.394"	1.260"	1.378"	TCMT 1.21_	6811235	9355111
6943335	BS-10-16-T02	.512"	1.378"	1.772"	TCMT 1.81.5_	6811250	9355222
6943336	BS-12-16-T02	.630"	1.496"	2.244"	TCMT 1.81.5_	6811250	9355222
6943337	BS-16-16-T02	.787"	1.692"	2.874"	TCMT 1.81.5_	6811250	9355222
6943338	BS-34-16-T04	1.496"	2.322"	3.228"	TCMT 32.5_	6811260	9355555
6922243	BS-2CT-T04 cartridge	2.204"	3.937"	.787"	TCMT 32.5_	6811260	9355555

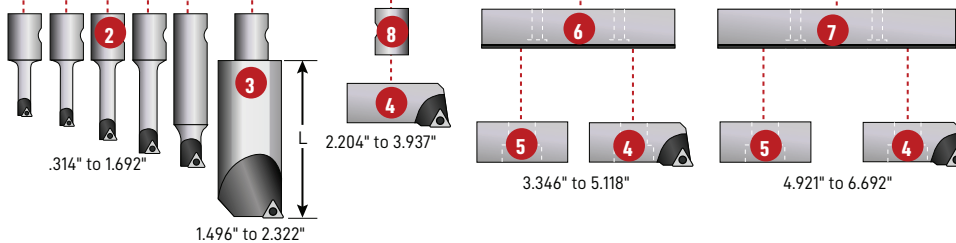
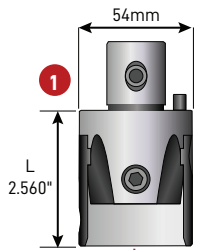

# BOHRSTAR 170 KIT - RHOMBIC INSERTS

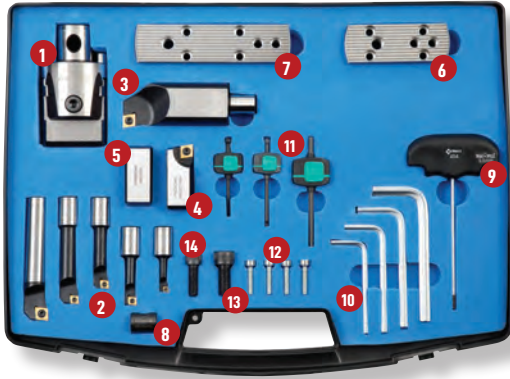

## INCLUDES RHOMBIC INSERTS:

- 1 Pc. EPMT 1.5\_
- 3 Pcs. CCMT 21.5\_
- 3 Pcs. CCMT 32.5\_

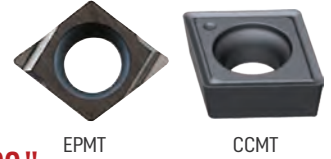

**RANGE: 0.314" TO 6.69"**

Kit Part No.	Description	Range
6991230	BS-54-KIT-RC-8-170	0.314" – 6.69"

## BOHRSTAR 170 KIT INCLUDES THESE COMPONENTS

Part No.	Description	Length
<b>1</b> 6951234	BS-54-16-W head	2.560"
6942234	BS-06-16-R02 6mm bar	.984"
6942235	BS-08-16-R03 8mm bar	1.378"
<b>2</b> 6942236	BS-10-16-R03 10mm bar	1.772"
6942237	BS-12-16-R03 12mm bar	2.244"
6942238	BS-16-16-R04 16mm bar	2.874"
<b>3</b> 6942239	BS-34-16-R04 34mm bar	3.228"
<b>4</b> 6921234	BS-2CT-R04 cartridge	.787"
<b>5</b> 6921235	BS-2CW counterweight	.728"
<b>6</b> 6921236	BS-SP-85-130 small plate	.787"
<b>7</b> 6921237	BS-SP-123-170 medium plate	.787"
<b>8</b> 6921239	BS-16-M10 location sleeve	-

Part No.	Description
<b>9</b> 6921243	A3 adjusting key
6962234	H4 hex wrench
6962235	H5 hex wrench
<b>10</b> 6962236	H6 hex wrench
6962238	H8 hex wrench
6972237	T7 Torx wrench
<b>11</b> 6972238	T8 Torx wrench
6972215	T15 Torx wrench
<b>12</b> 6921240	D-27-21 plate fixing screws
<b>13</b> 6921241	CS-10-25 cartridge screw
<b>14</b> 6921242	CS-08-25 counterweight screw

## KIT BORING BAR & INSERT SPECIFICATIONS

Boring Bar Part No.	Description	Bore Range		L	Insert	Insert Screw	Wrench
		Min	Max				
6942234	BS-06-16-R02	.314"	1.181"	.984"	EPMT 1.53_	6811220	9355222
6942235	BS-08-16-R03	.394"	1.260"	1.378"	CCMT 21.5_	6811235	9355333
6942236	BS-10-16-R03	.512"	1.378"	1.772"	CCMT 21.5_	6811250	9355333
6942237	BS-12-16-R03	.630"	1.496"	2.244"	CCMT 21.5_	6811250	9355333
6942238	BS-16-16-R04	.787"	1.692"	2.874"	CCMT 32.5_	6811260	9355555
6942239	BS-34-16-R04	1.496"	2.322"	3.228"	CCMT 32.5_	6811260	9355555
6921234	BS-2CT-R04 cartridge	2.204"	3.937"	.787"	CCMT 32.5_	6811260	9355555

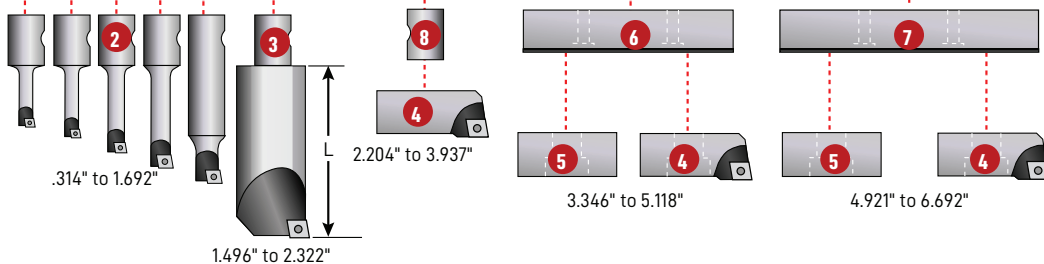
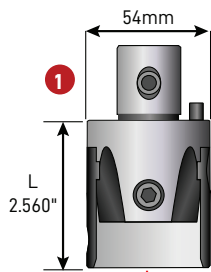

# BOHRSTAR 210 KIT - TRIANGULAR INSERTS

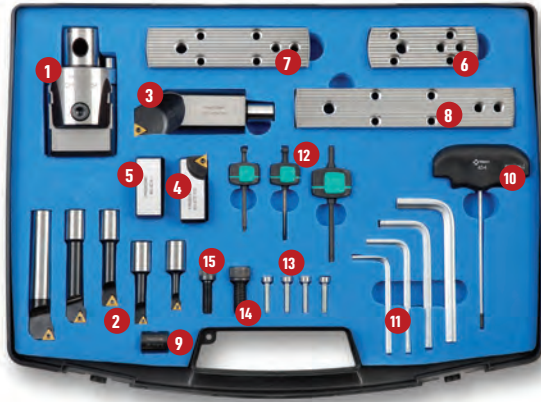
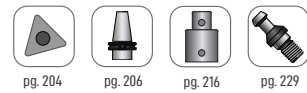

## INCLUDES TRIANGULAR INSERTS:

- 2 Pcs. TCMT 1.21\_
- 3 Pcs. TCMT 1.81\_
- 2 Pcs. TCMT 32.5\_



**RANGE: 0.314" TO 8.27"**

Kit Part No.	Description	Range
6991240	BS-54-KIT-TC-8-210	0.314" – 8.27"

## BOHRSTAR 210 KIT INCLUDES THESE COMPONENTS

Part No.	Description	Length
<b>1</b> 6951234	BS-54-16-W head	2.560"
6943333	BS-06-16-T01 6mm bar	.984"
6943334	BS-08-16-T01 8mm bar	1.378"
<b>2</b> 6943335	BS-10-16-T02 10mm bar	1.772"
6943336	BS-12-16-T02 12mm bar	2.244"
6943337	BS-16-16-T02 16mm bar	2.874"
<b>3</b> 6943338	BS-34-16-T04 34mm bar	3.228"
<b>4</b> 6922243	BS-2CT-T04 cartridge	.787"
<b>5</b> 6921235	BS-2CW counterweight	.728"
<b>6</b> 6921236	BS-SP-85-130 small plate	.787"
<b>7</b> 6921237	BS-SP-123-170 medium plate	.787"
<b>8</b> 6921238	BS-SP-165-210 large plate	.787"

Part No.	Description
<b>9</b> 6921239	BS-16-M10 location sleeve
<b>10</b> 6921243	A3 adjusting key
6962234	H4 hex wrench
<b>11</b> 6962235	H5 hex wrench
6962236	H6 hex wrench
6962238	H8 hex wrench
6972236	T6 Torx wrench
<b>12</b> 6972237	T7 Torx wrench
6972215	T15 Torx wrench
<b>13</b> 6921240	D-27-21 plate fixing screws
<b>14</b> 6921241	CS-10-25 cartridge screw
<b>15</b> 6921242	CS-08-25 counterweight screw

## KIT BORING BAR & INSERT SPECIFICATIONS

Boring Bar Part No.	Description	Bore Range			Insert	Insert Screw	Wrench
		Min	Max	L			
6943333	BS-06-16-T01	.314"	1.181"	.984"	TCMT 1.21_	6811220	9355111
6943334	BS-08-16-T01	.394"	1.260"	1.378"	TCMT 1.21_	6811235	9355111
6943335	BS-10-16-T02	.512"	1.378"	1.772"	TCMT 1.81.5_	6811250	9355222
6943336	BS-12-16-T02	.630"	1.496"	2.244"	TCMT 1.81.5_	6811250	9355222
6943337	BS-16-16-T02	.787"	1.692"	2.874"	TCMT 1.81.5_	6811260	9355222
6943338	BS-34-16-T04	1.496"	2.322"	3.228"	TCMT 32.5_	6811260	9355555
6922243	BS-2CT-T04 cartridge	2.204"	3.937"	.787"	CCMT 32.5_	6811260	9355555

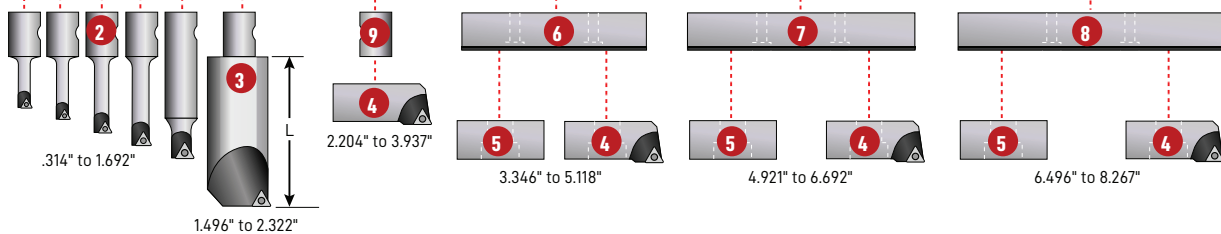
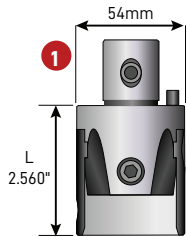

# BOHRSTAR 210 KITS - RHOMBIC INSERTS:

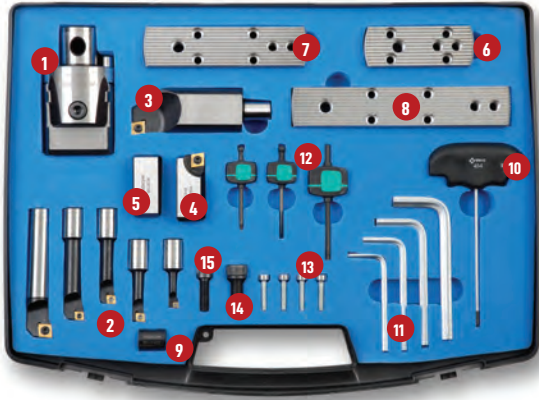

## INCLUDES RHOMBIC INSERTS:

- 1 Pc. EPMT 1.5\_
- 3 Pcs. CCMT 21.5\_
- 3 Pcs. CCMT 32.5\_

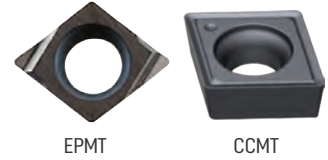

**RANGE: 0.314" TO 8.27"**

Kit Part No.	Description	Range
6991245	BS-54-KIT-RC-8-210	0.314" - 8.27"

## BOHRSTAR 210 KIT INCLUDES THESE COMPONENTS

Part No.	Description	Length
<b>1</b> 6951234	BS-54-16-W Head	2.560"
6942234	BS-06-16-R02 6mm bar	.984"
6942235	BS-08-16-R03 8mm bar	1.378"
<b>2</b> 6942236	BS-10-16-R03 10mm bar	1.772"
6942237	BS-12-16-R03 12mm bar	2.244"
6942238	BS-16-16-R04 16mm bar	2.874"
<b>3</b> 6942239	BS-34-16-R04 34mm bar	3.228"
<b>4</b> 6921234	BS-2CT-R04 Cartridge	.787"
<b>5</b> 6921235	BS-2CW Counterweight	.728"
<b>6</b> 6921236	BS-SP-85-130 Small plate	.787"
<b>7</b> 6921237	BS-SP-125-170 Medium plate	.787"
<b>8</b> 6921238	BS-SP-165-210 Large plate	.787"

Part No.	Description
<b>9</b> 6921239	BS-16-M10 Location sleeve
<b>10</b> 6921243	A3 Adjusting key
6962234	H4 hex wrench
6962235	H5 hex wrench
<b>11</b> 6962236	H6 hex wrench
6962238	H8 hex wrench
6972238	T8 Torx wrench
<b>12</b> 6972237	T7 Torx wrench
6972215	T15 Torx wrench
<b>13</b> 6921240	D-27-21 Plate fixing screws
<b>14</b> 6921241	CS-10-25 Cartridge screw
<b>15</b> 6921242	CS-08-25 Counterweight screw

## KIT BORING BAR & INSERT SPECIFICATIONS

Boring Bar	Part No.	Description	Bore Range			Insert	Insert Screw	Wrench
			Min	Max	L			
	6942234	BS-06-16-R02	.314"	1.181"	.984"	EPMT 1.53_	6811220	9355222
	6942235	BS-08-16-R03	.394"	1.260"	1.378"	CCMT 21.5_	6811235	9355333
	6942236	BS-10-16-R03	.512"	1.378"	1.772"	CCMT 21.5_	6811250	9355333
	6942237	BS-12-16-R03	.630"	1.496"	2.244"	CCMT 21.5_	6811250	9355333
	6942238	BS-16-16-R04	.787"	1.692"	2.874"	CCMT 32.5_	6811260	9355555
	6942239	BS-34-16-R04	1.496"	2.322"	3.228"	CCMT 32.5_	6811260	9355555
	6921234	BS-2CT-R04 Cartridge	2.204"	3.937"	.787"	CCMT 32.5_	6811260	9355555

Part No.	Description	Length
<b>9</b> 6921239	BS-16-M10 Location sleeve	2.204" to 3.937"
<b>6</b> 6921236	BS-SP-85-130 Small plate	3.346" to 5.118"
<b>7</b> 6921237	BS-SP-125-170 Medium plate	4.921" to 6.692"
<b>8</b> 6921238	BS-SP-165-210 Large plate	6.496" to 8.267"

# BOHRSTAR KIT MODULAR HOLDERS & ACCESSORIES

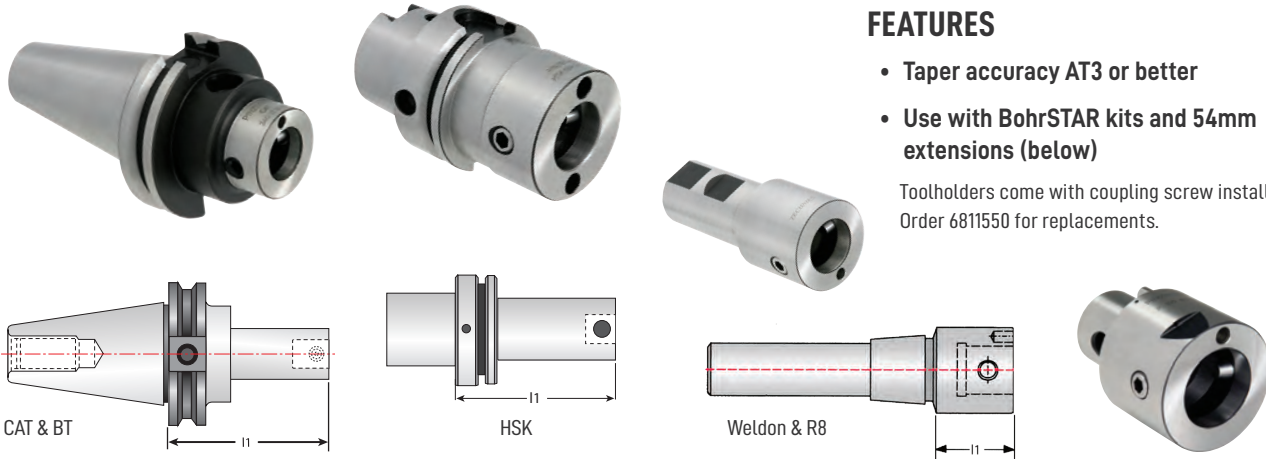

## FEATURES

- Taper accuracy AT3 or better
- Use with BohrSTAR kits and 54mm extensions (below)

Toolholders come with coupling screw installed. Order 6811550 for replacements.

## CAT40, CAT50, BT40 TOOLHOLDERS

Part No.	Spindle	Description	L1
6134310	CAT40	CT-340-54-120	3.00"
6134315	CAT40	CT-340-54-160	4.57"
6134320	CAT40	CT-340-54-200	6.14"
6141305	CAT50	CT-350-54-90	2.44"
6141310	CAT50	CT-350-54-160	5.20"
6141315	CAT50	CT-350-54-200	6.77"
6140400	BT40	BT-340-54-90	2.13"
6140425	BT40	BT-340-54-160	4.88"
6140450	BT40	BT-340-54-200	6.46"

## BT50, HSK, WELDON, R8 TOOLHOLDERS

Part No.	Spindle	Description	L1
6150375	BT50	BT-350-54-90	2.56"
6150400	BT50	BT-350-54-160	5.31"
6150425	BT50	BT-350-54-200	6.90"
6155635	HSK63	HSK-63A-54-110	2.76"
6155105	HSK100	HSK-100A-54-110	2.76"
6165343	Weldon	B-20-54-110-3/4	0.75"
6165103	Weldon	B-25-54-110-1.0	1.00"
6165144	Weldon	B-32-54-110-1-1/4	1.25"
6165123	Weldon	B-40-54-110-1-1/2	1.50"
6165805	R8	R8-54-110	1.50"

## EXTENSIONS

Part No.	Desc.	L
6555450	P-54-50	1.97"
6555475	P-54-75	2.95"

## COOLANT EXTENSION

Part No.	Desc.	L
6565450	P-54-50R	1.97"

The coolant-thru spindle extension directs coolant to the cutting zone for optimal stock removal rates.

## STOCK UP ON HIGH-PERFORMANCE LT1000 PVD INSERTS FOR BOHRSTAR KITS!

### FEATURES

- LT1000 PVD is 14 microns thick! (3.5x thicker)
- 250% longer insert life
- Great for exotics and stainless



### TRIANGULAR INSERTS FOR KITS

Part No.	Description	Grade
3533010	TCMT 1.2(1).50	5615
3533020	TCMT 1.2(1)1	5625
3563311	TCMT 1.8(1.5)0 HF	251
3533033	TCMT 1.8(1.5)1 HM	251
3563388	TCMT 1.8(1.5)2 HM	251
3563399	TCMT 1.8(1.5)1 HF	251
3533030	TCMT 1.8(1.5)1 PF4	5625
3564438	TCMT 3(2.5)1 NN	LT 10
3568851	TCMT 3(2.5)1 NN	LT 1000
3564441	TCMT 3(2.5)2 NN	LT 10
3568861	TCMT 3(2.5)2 NN	LT 1000

### RHOMBIC INSERTS FOR KITS

Part No.	Description	Grade
3663311	CCMT 2(1.5)0 HF	251
3664411	CCMT 2(1.5)1 NN	LT 10
3668011	CCMT 2(1.5)1 NN	LT 1000
3663399	CCMT 2(1.5)2 HM	251
3663344	CCMT 3(2.5)0 HF	251
3664413	CCMT 3(2.5)1 NN	LT 10
3668021	CCMT 3(2.5)1 NN	LT 1000
3664416	CCMT 3(2.5)2 NN	LT 10
3668026	CCMT 3(2.5)2 NN	LT 1000
3934030	EPMT 1.5(3).5 PM5	5625

We recommend LT1000 or LT10 grade inserts for best performance and extended insert life.





## PINZBOHR MODULAR BORING TOOLS

**MODULAR BORING SYSTEM - RANGE: 8.661" TO 19.685"**



### PINZBOHR MODULAR SYSTEM

PinzBOHR is a flexible boring system for holes ranging from 0.315" up to 19.685".

The system includes all necessary extensions and reducers, rough heads, finish heads and even includes face mill arbors and end mill holder options.



### MACROBOHR LARGE HOLE BORING SYSTEM

**RANGE: FROM 8.661" TO 40.157"**

The MacroBOHR boring system is a lightweight line of tools optimized for large diameter boring.

see page 219.





PinzBOHR boring heads are designed with insert pockets and cartridges that are integral with the body of the head to provide maximum rigidity and accuracy.

## FEATURES:

- Simple and extremely strong design for best reliability, rigidity, and repeatability.
- Flexible, modular system reduces tooling inventory.
- Top quality steel alloy hardened to 58-60 HRC.
- Precision ground components for highest accuracy.

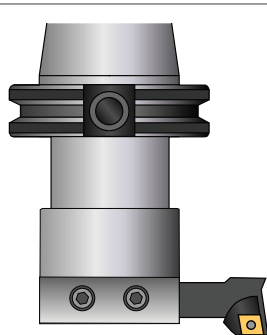
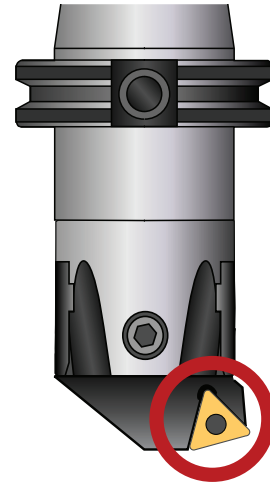

### OTHER DESIGN #1

Bar extension design is an unbalanced, weak solution, extending from the side of the head. Extension is subject to vibration and deflection during cutting, reducing accuracy and shortening insert life.

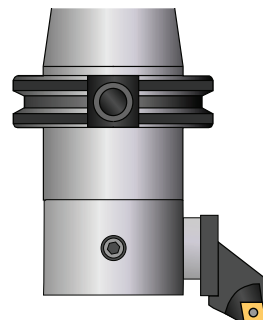

### OTHER DESIGN #2

Dogleg variation extends beyond the body of the boring head, allowing vibration and deflection.

## PRECISION

AccuSET graduated dial for fast and easy cutting adjustments in 0.0001" increments.



0.0001" graduated dial allows operators to quickly set the head to the necessary cutting diameter.

## RIGIDITY

Two offset center lock screws apply maximum tightening force between the boring head and the toolholder.

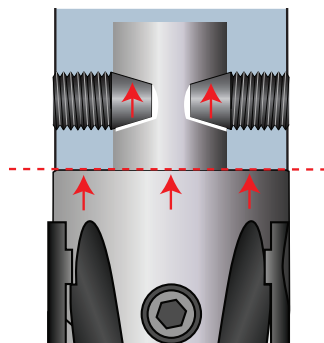

## SIMPLICITY

SafetySET feature prevents damage to the adjustment screw.

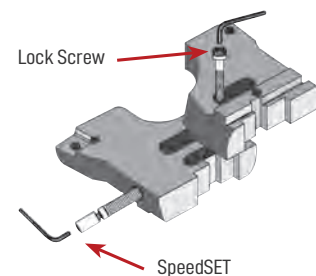

SpeedSET synchronized adjustment for setting of roughing heads.

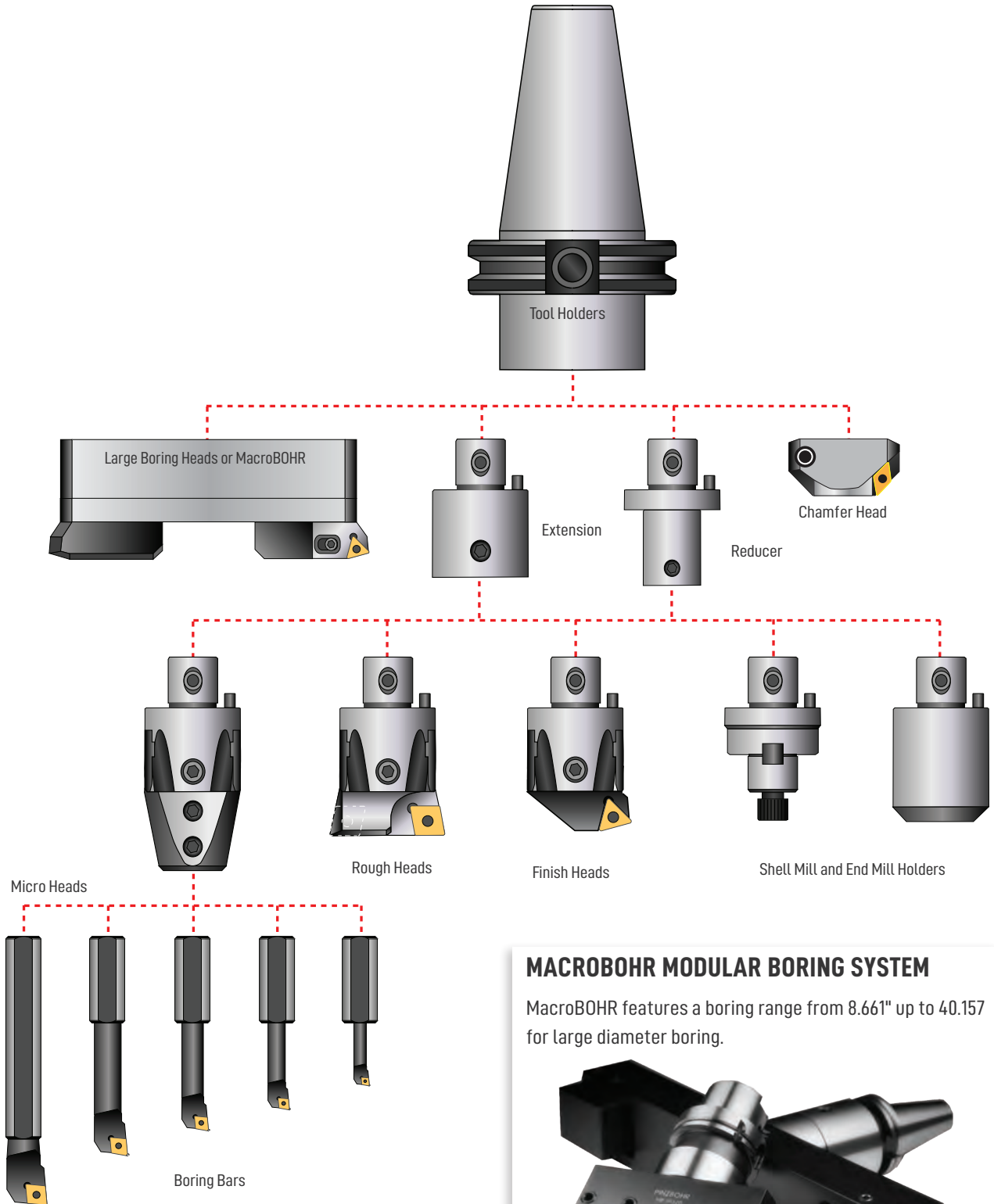

## MACROBOHR MODULAR BORING SYSTEM

MacroBOHR features a boring range from 8.661" up to 40.157" for large diameter boring.



## USING 75° BORING HEADS

Use a 75-degree head for thru holes when the hole position is accurate. A 75-degree head will tend to follow a pre-existing hole. A 75-degree head can also be used when there is a lot of stock to be removed. The lead angle will allow higher feed rates.

## USING 90° BORING HEADS

Use a 90-degree boring head when a hole is off-center, shifted, or off-angle. The 90-degree lead angle will have fewer tendencies to follow the existing hole. It is also used for blind or stepped holes and is the most versatile of our heads.

## USING BORING BARS

The diameter of the boring bar should always be less than the diameter of the pre-existing hole to allow proper chip evacuation.

5:1 length-to-diameter ratios can be achieved when roughing with steel bars.

3:1 length-to-diameter ratios can be achieved when finishing with steel bars.

7:1 length-to-diameter ratios can be achieved with carbide bars.

## THREE MAJOR INFLUENCES ON BORING

### 1. Depth of Cut (D.O.C.)

To determine the depth of a cut, take the finish diameter, minus the starting diameter and divide by two (2). The D.O.C. should always be greater than or equal to the nose radius of the insert. This will produce a stable cut with axial cutting forces. When D.O.C. is less than the radius, the forces are radial, and can cause chatter and deflection.

### 2. Feed Rate (IPR)

Feeds and speeds are always dependent upon material, machine, setup conditions (fixturing) and tool over-hang. The feed rate (IPR) should always be larger than the hone of the insert and at least 25% of the nose radius. This allows full use of the chip breaker. An IPR less than the hone will produce vibration, which will affect the tool life and surface finish.

### 3. Speed (SFPM)

Speed is the function of coating, nose radius, and over-hang. Higher speeds typically produce a better finish, shorter cycling times and better chip evacuation. Lower speed reduces the possibility of chatter, but also has higher cycle times and poorer quality finishes. This can also cause a built-up edge and reduce insert life. Sometimes coatings can be used to run higher surface footage, create better finish, and limit built-up edges.



75° Lead Angle Rough Head



90° Lead Angle Rough Head



Carbide or HSS Boring Bars



Use Micro Heads with Boring Bars



pg. 204



pg. 206



pg. 216



pg. 229

# MODULAR BORING MICROHEADS



## FEATURES

- AccuSET 0.0001" graduated dial allows fast and easy adjustments
- Tapered nose improves clearance
- Two offset center lock screws maximize rigidity while still permitting fast tool changes

Micro Heads available in five shank sizes for carbide and HSS boring bars.

Select a micro head with a "d2" dimension that matches the "d2" of the boring bar.

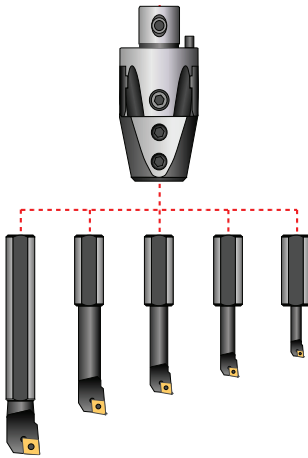
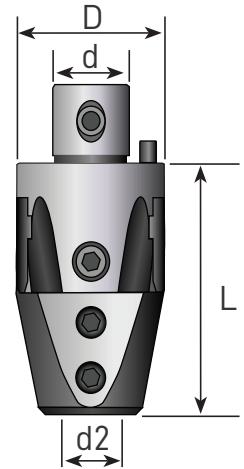

## EASY ADJUSTMENT

AccuSET graduated adjustment dial



Adjustable in 0.0001" increments

Metric dials available

0.0001" dial allows operators to quickly set the finish head to any diameter.

## PROCEDURE:

1. Loosen locking screw
2. Remove any backlash
3. Rotate scale to desired setting
4. Tighten locking screw

## ACCUSET MICRO HEADS

Part No.	Description	Range		D (mm)	d (mm)	d2 (mm)	L
		Min	Max				
6011000	A-27-006	.315"	.787"	27	15	6	1.97"
6011050	A-27-008	.394"	.827"	27	15	8	1.97"
6011100	A-32-008	.394"	.827"	32	18	8	2.28"
6011150	A-32-010	.512"	.984"	32	18	10	2.28"
6011200	A-42-010	.512"	1.142"	42	24	10	2.76"
6011250	A-42-012	.63"	1.339"	42	24	12	2.76"
6011300	A-42-016	.787"	1.496"	42	24	16	2.76"

Note: All wrenches are included with each boring head. No special tools are needed.

# BORING BARS FOR MICRO HEADS



Select a boring bar with a "d2" dimension that matches the "d2" of the head.

## FEATURES

- 16mm shanks for A-42-016 micro head
- Manufactured from HSS or Carbide
- Precision ground shank

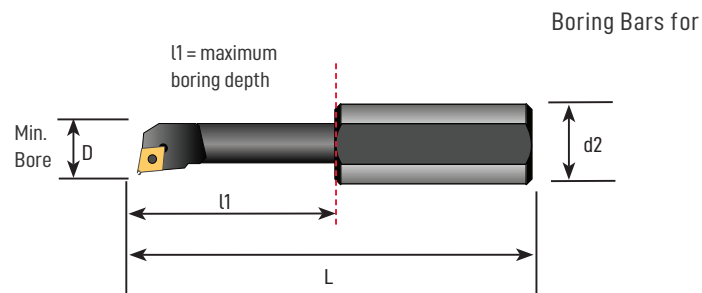

5:1 length-to-diameter ratios can be achieved when roughing with steel bars.  
3:1 length-to-diameter ratios can be achieved when finishing with steel bars.

The shortest bar overhang possible should be used to maximize results.

## HSS BORING BARS FOR MICRO HEAD A-42-016

Part No.	Description	D Min. Bore	d2 (mm)	L	l1	Insert	Screw	Wrench
6711225	S06-16SELPR-04	.315"	16	2.598"	.984"	EPGT 1.21_L	6811210	9355111
6711235	S06-16SELPR-05	.315"	16	2.598"	.984"	EPMT 1.53_	6811220	9355111
6722225	S06-16STFCR-06	.315"	16	2.598"	.984"	TCMT 1.21_	6811215	9355111
6711245	S08-16SCLCR-06	.394"	16	2.992"	1.377"	CCMT 21.5_	6811235	9355222
6722235	S08-16STFCR-06	.394"	16	2.992"	1.377"	TCMT 1.21_	6811215	9355111
6711255	S10-16SCLCR-06	.512"	16	3.386"	1.771"	CCMT 21.5_	6811250	9355222
6722245	S10-16STFCR-09	.512"	16	3.386"	1.771"	TCMT 1.81.5_	6811230	9355222
6711265	S12-16SCLCR-06	.630"	16	3.858"	2.244"	CCMT 21.5_	6811255	9355222
6722255	S12-16STFCR-09	.630"	16	3.858"	2.244"	TCMT 1.81.5_	6811230	9355222
6711275	S16-16SCLCR-09	.787"	16	4.488"	2.874"	CCMT 32.5_	6811260	9355555
6722265	S16-16STFCR-09	.787"	16	4.488"	2.874"	TCMT 1.81.5_	6811230	9355222
6722275	S16-16STFCR-16	.787"	16	4.488"	2.874"	TCMT 32.5_	6811260	9355555

## CARBIDE BORING BAR FOR MICRO HEAD A-42-016

Part No.	Description	D Min. Bore	d2 (mm)	L	l1	Insert	Screw	Wrench
6733265	C16L-SCLCR-09	.787"	16	5.512"	4.409"	CCMT 32.5_	6811260	T15



## FEATURES

- Minimum bore .315"
- Maximum bore 1.496"
- Carbide or HSS

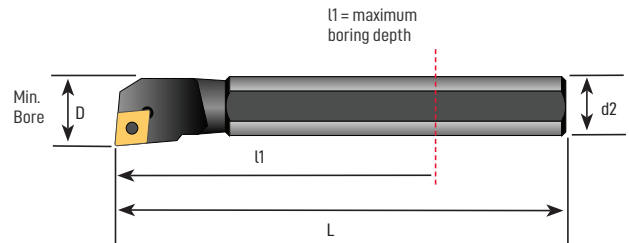

Select a boring bar with a "d2" dimension that matches the "d2" of the head.

## USAGE

- 7:1 length-to-diameter ratios can be achieved with carbide bars
- 5:1 for roughing with steel bars
- 3:1 for finishing with steel bars

## CARBIDE SHANK BORING BARS

Part No.	Description	Micro Head	Min. Bore	d2	L	l1	Insert	Screw	Wrench
6733225	C06F-SELPR-04	A-27-006	.315"	6mm	3.150"	2.204"	EPGT1.21_L	6811210	T6
6733230	C06-08H-SELPR-05	A-27-008 or A-32-008	.315"	8mm	3.150"	2.204"	EMPT1.53_	6811210	T6
6733235	C08G-SCLCR-06	A-27-008 or A-32-008	.394"	8mm	3.543"	2.362"	CCMT21.5_	6811235	T7
6733245	C10J-SCLCR-06	A-32-010 or A-42-010	.512"	10mm	4.331"	2.913"	CCMT21.5_	6811250	T7
6733255	C12K-SCLCR-06	A-42-012	.630"	12mm	4.921"	3.503"	CCMT21.5_	6811255	T7
6733265	C16L-SCLCR-09	A-42-016	.787"	16mm	5.512"	4.094"	CCMT32.5_	6811260	T15

## HSS SHANK BORING BARS

Part No.	Description	Micro Head	Min. Bore	d2	L	l1	Insert	Screw	Wrench
6733227	S06E-SELPR-04	A-27-006	.315"	6mm	2.756"	1.811"	EPGT1.21_L	6811210	T6
6733232	S06E-SELPR-05	A-27-006	.315"	6mm	2.756"	1.811"	EMPT1.53_	6811210	T6
6733237	S08F-SCLCR-06	A-27-008 or A32-008	.394"	8mm	3.150"	1.968"	CCMT21.5_	6811235	T7
6733247	S10G-SCLCR-06	A-32-010 or A42-010	.512"	10mm	3.543"	2.125"	CCMT21.5_	6811250	T7
6733257	S12H-SCLCR-06	A-42-012	.630"	12mm	3.937"	2.519"	CCMT21.5_	6811255	T7
6733267	S16J-SCLCR-09	A-42-016	.787"	16mm	4.331"	2.913"	CCMT32.5_	6811260	T15



# 75° LEAD ANGLE ROUGHING HEADS



pg. 204



pg. 206



pg. 216



pg. 229



Integral pocket type



Cartridge type rough head

## FEATURES

- SpeedSET feature adjusts both sides at the same time
- SafetySET feature prevents accidental damage to the adjustment screw
- Two insert pockets for faster cutting

**RANGE: .945" TO 8.661"**

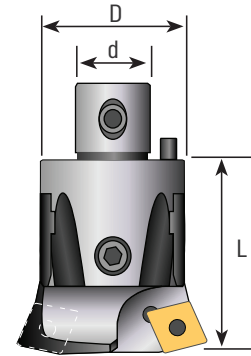

## 75° ROUGHING HEADS INTEGRAL POCKET TYPE

Part No.	Description	Range		D (mm)	d (mm)	L	Insert	Screw
		Min	Max					
6275100	D-22-75-400	.945"	1.181"	22	12	1.39"	CCMT 21.5_	6811250
6275105	D-27-75-409	1.142"	1.575"	27	15	1.65"	CCMT 32.5_	6811260
6275115	D-32-75-409	1.535"	1.969"	32	18	1.77"	CCMT 32.5_	6811260
6275120	D-42-75-300	1.929"	2.559"	42	24	2.20"	TCMT 1.81_	6811262
6275125	D-42-75-402	1.929"	2.559"	42	24	2.20"	CCMT 43_	6811266
6275130	D-42-75-402N	2.087"	2.559"	42	24	2.20"	CNMG 43_	6811270
6275135	D-54-75-300	2.48"	3.228"	54	28	2.60"	TCMT 1.81_	6811262
6275140	D-54-75-402	2.48"	3.228"	54	28	2.60"	CCMT 43_	6811 266
6275145	D-54-75-402N	2.48"	3.228"	54	28	2.60"	CNMG 43_	6811270

## 75° ROUGHING HEADS CARTRIDGE TYPE

Part No.	Description	Range		Cartridge	D (mm)	d (mm)	L	Insert	Screw
		Min	Max						
6275150	D-68-75-2CT-300	3.15"	4.016"	2CT-75-300	68	36	3.39"	TCMT 1.81.5_	6811262
6275155	D-68-75-2CT-402	3.15"	4.016"	2CT-75-402	68	36	3.39"	CCMT 43_	6811266
6275160	D-68-75-2CT-402N	3.15"	4.016"	2CT-75-402N	68	36	3.39"	CNMG 43_	6811270
6275165	D-85-75-3CT-300	3.937"	4.921"	3CT-75-300	85	50	3.94"	TCMT 32.5_	6811262
6275170	D-85-75-3CT-402	3.937"	4.921"	3CT-75-402	85	50	3.94"	CCMT 43_	6811266
6275175	D-85-75-3CT-402N	3.937"	4.921"	3CT-75-402N	85	50	3.94"	CNMG 43_	6811270
6275180	D-100-75-3CT-300	4.921"	6.299"	3CT-75-300	110	60	3.94"	TCMT 32.5_	6811262
6275185	D-100-75-3CT-402	4.921"	6.299"	3CT-75-402	110	60	3.94"	CCMT 43_	6811266
6275190	D-100-75-3CT-402N	4.921"	6.299"	3CT-75-402N	110	60	3.94"	CNMG 43_	6811270
6275195	D-200-75-3CT-300	6.299"	8.661"	2CT-75-300	145	60	3.94"	TCMT 32.5_	6811262
6275200	D-200-75-3CT-402	6.299"	8.661"	3CT-75-402	145	60	3.94"	CCMT 43_	6811266
6275205	D-200-75-3CT-402N	6.299"	8.661"	3CT-75-402N	145	60	3.94"	CNMG 432_	6811270

AccuSET dial not available on small rough heads due to their design differences.



SafetySET feature not available on large boring heads due to their design differences.

## FEATURES

- Two AccuSET graduated dials for easy adjustments in 0.0001" increments
- Top quality steel alloy hardened to 58-60 HRC
- Precision ground components for accuracy

**RANGE: 8.661" TO 19.685"**

75° lead angle head tends to self-center in the pilot hole, stabilizing the cut and maximizing stock removal rates.

## EASY ADJUSTMENT

AccuSET graduated adjustment dial

0.0001" dial allows operators to quickly set the finish head to any diameter.



Adjustable in 0.0001" increments

Metric dials available

## PROCEDURE:

1. Loosen locking screw
2. Remove any backlash
3. Rotate scale to desired setting
4. Tighten locking screw



Use large boring heads with direct mount toolholders or ADT 100-50 adapter and a toolholder with a 100mm connection.

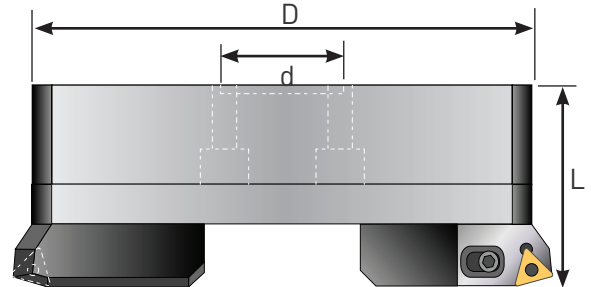

## 75° LARGE ROUGHING HEADS

Part No.	Description	Range		Cartridge	D (mm)	d (mm)	L	Insert	Screw
		Min	Max						
6275210	D-300-75-3CT-300	8.661"	12.598"	3CT-75-300	202	60	3.54"	TCMT 32.5_	6811262
6275215	D-300-75-3CT-402	8.661"	12.598"	3CT-75-402	202	60	3.54"	CCMT 43_	6811266
6275220	D-300-75-3CT-402N	8.661"	12.598"	3CT-75-402N	202	60	3.54"	CNMG 43_	6811270
6275225	D-400-75-3CT-300	11.417"	15.748"	3CT-75-300	272	60	3.54"	TCMT 32.5_	6811262
6275230	D-400-75-3CT-402	11.417"	15.748"	3CT-75-402	272	60	3.54"	CCMT 43_	6811266
6275235	D-400-75-3CT-402N	11.417"	15.748"	3CT-75-402N	272	60	3.54"	CNMG 43_	6811270
6275240	D-500-75-3CT-300	14.567"	19.685"	3CT-75-300	352	60	3.54"	TCMT 32.5_	6811262
6275245	D-500-75-3CT-402	14.567"	19.685"	3CT-75-402	352	60	3.54"	CCMT 43_	6811266
6275250	D-500-75-3CT-402N	14.567"	19.685"	3CT-75-402N	352	60	3.54"	CNMG 43_	6811270

SafetySET feature not available on large boring heads due to their design differences.

# 90° LEAD ANGLE ROUGHING HEADS



Integral pocket type



Cartridge type rough head

## FEATURES

- SpeedSET feature adjusts both sides at the same time
- SafetySET feature prevents accidental damage to the adjustment screw
- Two insert pockets for faster cutting

**RANGE: .945" TO 8.661"**

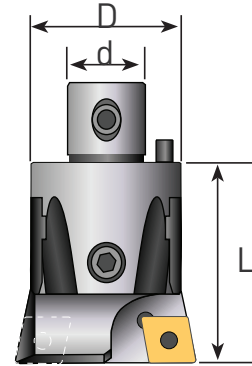

## 90° ROUGHING HEADS INTEGRAL POCKET TYPE

Part No.	Description	Range		D (mm)	d (mm)	L	Insert	Screw
		Min	Max					
6390100	D-22-90-400	.945"	1.181"	22	12	1.39"	CCMT 21.5_	6811250
6390105	D-27-90-409	1.142"	1.575"	27	15	1.65"	CCMT 32.5_	6811260
6390110	D-32-90-409	1.535"	1.969"	32	18	1.77"	CCMT 32.5_	6811260
6390115	D-42-90-300	1.929"	2.559"	42	24	2.20"	TCMT 32.5_	6811262
6390120	D-42-90-402	1.929"	2.559"	42	24	2.20"	CCMT 43_	6811266
6390125	D-42-90-402N	2.087"	2.559"	42	24	2.20"	CNMG 43_	6811270
6390130	D-54-90-300	2.48"	3.228"	54	28	2.60"	TCMT 32.5_	6811262
6390135	D-54-90-402	2.48"	3.228"	54	28	2.60"	CCMT 43_	6811266
6390140	D-54-90-402N	2.48"	3.228"	54	28	2.60"	CNMG 43_	6811270

## 90° ROUGHING HEADS CARTRIDGE TYPE

Part No.	Description	Range		Cartridge	D (mm)	d (mm)	L	Insert	Screw
		Min	Max						
6390145	D-68-90-2CT-300	3.15"	4.016"	2CT-90-300	68	36	3.39"	TCMT 32.5_	6811262
6390150	D-68-90-2CT-402	3.15"	4.016"	2CT-90-402	68	36	3.39"	CCMT 43_	6811266
6390155	D-68-90-2CT-402N	3.15"	4.016"	2CT-90-402N	68	36	3.39"	CNMG 43_	6811270
6390160	D-85-90-3CT-300	3.937"	4.921"	3CT-90-300	85	50	3.94"	TCMT 32.5_	6811262
6390165	D-85-90-3CT-402	3.937"	4.921"	3CT-90-402	85	50	3.94"	CCMT 43_	6811266
6390170	D-85-90-3CT-402N	3.937"	4.921"	3CT-90-402N	85	50	3.94"	CNMG 43_	6811270
6390175	D-100-90-3CT-300	4.921"	6.299"	3CT-90-300	110	60	3.94"	TCMT 32.5_	6811262
6390180	D-100-90-3CT-402	4.921"	6.299"	3CT-90-402	110	60	3.94"	CCMT 43_	6811266
6390185	D-100-90-3CT-402N	4.921"	6.299"	3CT-90-402N	110	60	3.94"	CNMG 43_	6811270
6390190	D-200-90-3CT-300	6.299"	8.661"	2CT-90-300	145	60	3.94"	TCMT 32.5_	6811262
6390200	D-200-90-3CT-402	6.299"	8.661"	3CT-90-402	145	60	3.94"	CCMT 43_	6811266
6390205	D-200-90-3CT-402N	6.299"	8.661"	3CT-90-402N	145	60	3.94"	CNMG 43_	6811270

AccuSET feature not available on small boring heads due to their design differences.



pg. 204



pg. 206



pg. 216



pg. 229

# 90° LEAD ANGLE ROUGHING HEADS



SafetySET feature not available on large boring heads due to their design differences.

## FEATURES

- Two AccuSET graduated dials for easy adjustments in 0.0001" increments
- Top quality steel alloy hardened to 58-60 HRC
- Precision ground components for accuracy

**RANGE: 8.661" TO 19.685"**

Use 90° lead angle heads when performing blind boring, or if the desired hole is not exactly on center with your pilot hole. The 90° lead will have less tendency to follow the pilot hole.

## EASY ADJUSTMENT

AccuSET graduated adjustment dial



Adjustable in 0.0001" increments

Metric dials available

0.0001" dial allows operators to quickly set the finish head to any diameter.

## PROCEDURE:

1. Loosen locking screw
2. Remove any backlash
3. Rotate scale to desired setting
4. Tighten locking screw

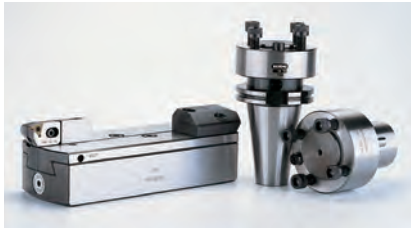

Use large boring heads with direct mount toolholders or ADT 100-50 adapter and a toolholder with a 100mm connection.

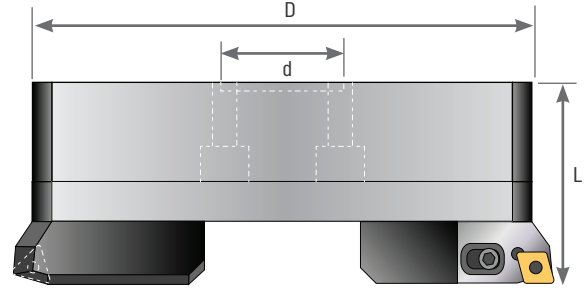

## 90° LARGE ROUGHING HEADS

Part No.	Description	Range		Cartridge	D (mm)	d (mm)	L	Insert	Screw
		Min	Max						
6390210	D-300-90-3CT-300	8.661"	12.598"	3CT-90-300	202	60	3.54"	TCMT 32.5_	6811262
6390215	D-300-90-3CT-402	8.661"	12.598"	3CT-90-402	202	60	3.54"	CCMT 43_	6811266
6390220	D-300-90-3CT-402N	8.661"	12.598"	3CT-90-402N	202	60	3.54"	CNMG 43_	6811270
6390225	D-400-90-3CT-300	11.417"	15.748"	3CT-90-300	272	60	3.54"	TCMT 32.5_	6811262
6390230	D-400-90-3CT-402	11.417"	15.748"	3CT-90-402	272	60	3.54"	CCMT 43_	6811266
6390235	D-400-90-3CT-402N	11.417"	15.748"	3CT-90-402N	272	60	3.54"	CNMG 43_	6811270
6390240	D-500-90-3CT-300	14.567"	19.685"	3CT-90-300	352	60	3.54"	TCMT 32.5_	6811262
6390245	D-500-90-3CT-402	14.567"	19.685"	3CT-90-402	352	60	3.54"	CCMT 43_	6811266
6390250	D-500-90-3CT-402N	14.567"	19.685"	3CT-90-402N	352	60	3.54"	CNMG 43_	6811270

SafetySET feature not available on large boring heads due to their design differences.

# 75° LEAD ANGLE FINISHING HEADS



Integral pocket type



Cartridge type

## FEATURES

- AccuSET slide includes graduated dial for fast adjustments in 0.0001" increments
- Manufactured from top quality steel alloy, hardened to 58-60 HRC to minimize wear
- Pin-and-taper coupling system ensures maximum rigidity

**RANGE: .945" TO 8.661"**

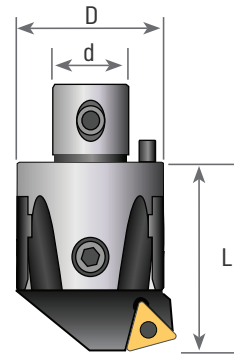

## 75° FINISHING HEADS INTEGRAL POCKET TYPE

Part No.	Description	Range		D (mm)	d (mm)	L	Insert	Screw
		Min	Max					
6275255	A-22-75-400	.945"	1.181"	22	12	1.39"	CCMT 21.5_	6811250
6275260	A-27-75-409	1.142"	1.575"	27	15	1.65"	CCMT 32.5_	6811260
6275265	A-32-75-409	1.535"	1.969"	32	18	1.77"	CCMT 32.5_	6811260
6275270	A-42-75-300	1.929"	2.559"	42	24	2.20"	TCMT 32.5_	6811262
6275275	A-54-75-300	2.48"	3.228"	54	28	2.60"	TCMT 32.5_	6811262

## 75° FINISHING HEADS CARTRIDGE TYPE

Part No.	Description	Range		Cartridge	D (mm)	d (mm)	L	Insert	Screw
		Min	Max						
6275280	A-68-75-2CT-300	3.15"	4.016"	2CT-75-300	68	36	3.39"	TCMT 32.5_	6811262
6275285	A-68-75-2CT-402	3.15"	4.016"	2CT-75-402	68	36	3.39"	CCMT 43_	6811266
6275290	A-68-75-2CT-402N	3.15"	4.016"	2CT-75-402N	68	36	3.39"	CNMG 43_	6811270
6275295	A-85-75-3CT-300	3.937"	4.921"	3CT-75-300	85	50	3.94"	TCMT 32.5_	6811262
6275300	A-85-75-3CT-402	3.937"	4.921"	3CT-75-402	85	50	3.94"	CCMT 43_	6811266
6275305	A-85-75-3CT-402N	3.937"	4.921"	3CT-75-402N	85	50	3.94"	CNMG 43_	6811270
6275310	A-100-75-3CT-300	4.921"	6.299"	3CT-75-300	110	60	3.94"	TCMT 32.5_	6811262
6275315	A-100-75-3CT-402	4.921"	6.299"	3CT-75-402	110	60	3.94"	CCMT 43_	6811266
6275320	A-100-75-3CT-402N	4.921"	6.299"	3CT-75-402N	110	60	3.94"	CNMG 43_	6811270
6275325	A-200-75-3CT-300	6.299"	8.661"	2CT-75-300	145	60	3.94"	TCMT 32.5_	6811262
6275330	A-200-75-3CT-402	6.299"	8.661"	3CT-75-402	145	60	3.94"	CCMT 43_	6811266
6275335	A-200-75-3CT-402N	6.299"	8.661"	3CT-75-402N	145	60	3.94"	CNMG 43_	6811270



## FEATURES

- AccuSET 0.0001" graduated dial for precision adjustments
- Designed for maximum rigidity and accuracy
- Top quality steel alloy hardened to 58-60 HRC

**RANGE: 8.661" TO 19.685"**

75° lead angle head tends to self-center in the pilot hole, stabilizing the cut and maximizing stock removal rates.

## EASY ADJUSTMENT

AccuSET graduated adjustment dial.



Adjustable in 0.0001" increments

Metric dials available

0.0001" dial allows operators to quickly set the finish head to any diameter.

## PROCEDURE:

1. Loosen locking screw
2. Remove any backlash
3. Rotate scale to desired setting
4. Tighten locking screw



Use large boring heads with direct mount toolholders or ADT 100-50 adapter and a toolholder with a 100mm connection.

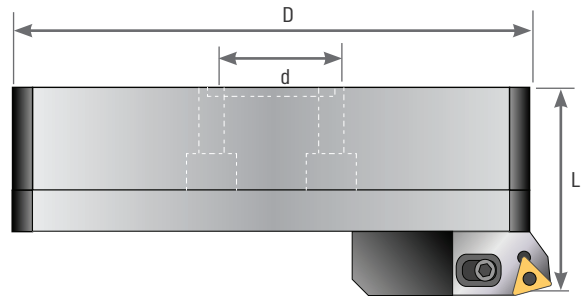

## 75° LARGE FINISHING HEADS

Part No.	Description	Range		Cartridge	D (mm)	d (mm)	L	Insert	Screw
		Min	Max						
6275340	A-300-75-3CT-300	8.661"	12.598"	3CT.75.300	202	60	3.54"	TCMT 32.5_	6811262
6275345	A-300-75-3CT-402	8.661"	12.598"	3CT.75.402	202	60	3.54"	CCMT 43_	6811266
6275350	A-300-75-3CT-402N	8.661"	12.598"	3CT.75.402N	202	60	3.54"	CNMG 43_	6811270
6275355	A-400-75-3CT-300	11.417"	15.748"	3CT.75.300	272	60	3.54"	TCMT 32.5_	6811262
6275360	A-400-75-3CT-402	11.417"	15.748"	3CT.75.402	272	60	3.54"	CCMT 43_	6811266
6275365	A-400-75-3CT-402N	11.417"	15.748"	3CT.75.402N	272	60	3.54"	CNMG 43_	6811270
6275370	A-500-75-3CT-300	14.567"	19.685"	3CT.75.300	352	60	3.54"	TCMT 32.5_	6811262
6275375	A-500-75-3CT-402	14.567"	19.685"	3CT.75.402	352	60	3.54"	CCMT 43_	6811266
6275380	A-500-75-3CT-402N	14.567"	19.685"	3CT.75.402N	352	60	3.54"	CNMG 43_	6811270



# 90° LEAD ANGLE FINISHING HEADS



Integral pocket type



Cartridge type

## FEATURES

- AccuSET slide includes graduated dial for fast adjustments in 0.0001" increments
- Manufactured from top quality steel alloy, hardened to 58-60 HRC to minimize wear
- Pin-and-taper coupling system ensures maximum rigidity

**RANGE: .945" TO 8.661"**

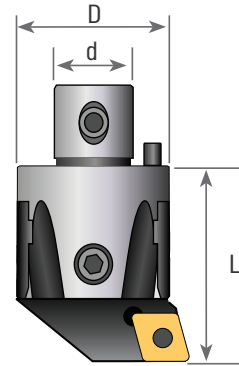

## 90° FINISHING HEADS INTEGRAL POCKET TYPE

Part No.	Description	Range		D (mm)	d (mm)	L	Insert	Screw
		Min	Max					
6390255	A-22-90-400	.945"	1.181"	22	12	1.39"	CCMT 21.5_	6811250
6390260	A-27-90-409	1.142"	1.575"	27	15	1.65"	CCMT 32.5_	6811260
6390265	A-32-90-300	1.535"	1.969"	32	18	1.77"	TCMT 32.5_	6811262
6390270	A-32-90-409	1.535"	1.969"	32	18	1.77"	CCMT 32.5_	6811260
6390275	A-42-90-300	1.929"	2.559"	42	24	2.20"	TCMT 32.5_	6811262
6390280	A-42-90-402	1.929"	2.559"	42	24	2.20"	CCMT 43_	6811266
6390285	A-42-90-402N	2.087"	2.559"	42	24	2.20"	CNMG 43_	6811270
6390290	A-54-90-300	2.48"	3.228"	54	28	2.60"	TCMT 32.5_	6811262
6390295	A-54-90-402	2.48"	3.228"	54	28	2.60"	CCMT 43_	6811266
6390300	A-54-90-402N	2.48"	3.228"	54	28	2.60"	CNMG 43_	6811270

## 90° FINISHING HEADS CARTRIDGE TYPE

Part No.	Description	Range		Cartridge	D (mm)	d (mm)	L	Insert	Screw
		Min	Max						
6390305	A-68-90-2CT-300	3.15"	4.016"	2CT-90-300	68	36	3.39"	TCMT 32.5_	6811262
6390310	A-68-90-2CT-402	3.15"	4.016"	2CT-90-402	68	36	3.39"	CCMT 43_	6811266
6390315	A-68-90-2CT-402N	3.15"	4.016"	2CT-90-402N	68	36	3.39"	CNMG 43_	6811270
6390320	A-85-90-3CT-300	3.937"	4.921"	3CT-90-300	85	50	3.94"	TCMT 32.5_	6811262
6390325	A-85-90-3CT-402	3.937"	4.921"	3CT-90-402	85	50	3.94"	CCMT 43_	6811266
6390330	A-85-90-3CT-402N	3.937"	4.921"	3CT-90-402N	85	50	3.94"	CNMG 43_	6811270
6390335	A-100-90-3CT-300	4.921"	6.299"	3CT-90-300	110	60	3.94"	TCMT 32_	6811262
6390340	A-100-90-3CT-402	4.921"	6.299"	3CT-90-402	110	60	3.94"	CCMT 43_	6811266
6390345	A-100-90-3CT-402N	4.921"	6.299"	3CT-90-402N	110	60	3.94"	CNMG 43_	6811270
6390350	A-200-90-3CT-300	6.299"	8.661"	2CT-90-300	145	60	3.94"	TCMT 32.5_	6811262
6390355	A-200-90-3CT-402	6.299"	8.661"	3CT-90-402	145	60	3.94"	CCMT 43_	6811266
6390360	A-200-90-3CT-402N	6.299"	8.661"	3CT-90-402N	145	60	3.94"	CNMG 43_	6811270



pg. 204



pg. 206



pg. 216



pg. 229

# 90° LEAD ANGLE FINISHING HEADS



## FEATURES

- AccuSET 0.0001" graduated dial for precision adjustments
- Designed for maximum rigidity and accuracy
- Top quality steel alloy hardened to 58-60 HRC

**RANGE: 8.661" TO 19.685"**

Use 90° lead angle heads when performing blind boring, or if the desired hole is not exactly on center with your pilot hole. The 90° lead will have less tendency to follow the pilot hole.

## EASY ADJUSTMENT

AccuSET graduated adjustment dial.



Adjustable in 0.0001" increments

Metric dials available

0.0001" dial allows operators to quickly set the finish head to any diameter.

## PROCEDURE:

1. Loosen locking screw
2. Remove any backlash
3. Rotate scale to desired setting
4. Tighten locking screw



Use large boring heads with direct mount toolholders or ADT 100-50 adapter and a toolholder with a 100mm connection.

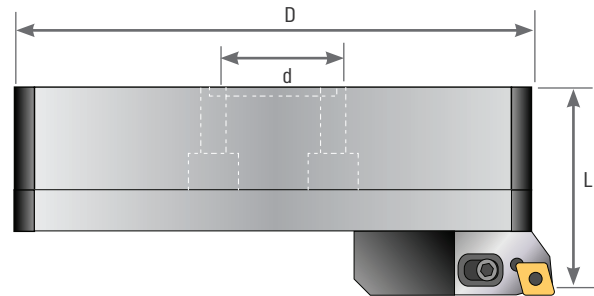

## 90° LARGE FINISHING HEADS

Part No.	Description	Range		Cartridge	D (mm)	d (mm)	L	Insert	Screw
		Min	Max						
6390365	A-300-90-3CT-300	8.661"	12.598"	3CT-90-300	202	60	3.54"	TCMT 32.5_	6811262
6390370	A-300-90-3CT-402	8.661"	12.598"	3CT-90-402	202	60	3.54"	CCMT 43_	6811266
6390375	A-300-90-3CT-402N	8.661"	12.598"	3CT-90-402N	202	60	3.54"	CNMG 43_	6811270
6390380	A-400-90-3CT-300	11.417"	15.748"	3CT-90-300	272	60	3.54"	TCMT 32.5_	6811262
6390385	A-400-90-3CT-402	11.417"	15.748"	3CT-90-402	272	60	3.54"	CCMT 43_	6811266
6390390	A-400-90-3CT-402N	11.417"	15.748"	3CT-90-402N	272	60	3.54"	CNMG 43_	6811270
6390395	A-500-90-3CT-300	14.567"	19.685"	3CT-90-300	352	60	3.54"	TCMT 32.5_	6811262
6390400	A-500-90-3CT-402	14.567"	19.685"	3CT-90-402	352	60	3.54"	CCMT 43_	6811266
6390405	A-500-90-3CT-402N	14.567"	19.685"	3CT-90-402N	352	60	3.54"	CNMG 43_	6811270

# 75° ULTRAFINE FINISHING HEADS



Uses ISO standard inserts

UltraFINE finish heads feature an 11° relief angle that provides an ultra-smooth finish, reducing the need for extra operations.

## FEATURES

- AccuSET slide includes graduated dial for fast adjustments in 0.0001" increments
- Manufactured from top quality steel alloy, hardened to 58-60 HRC to minimize wear
- Pin-and-taper coupling system ensures maximum rigidity

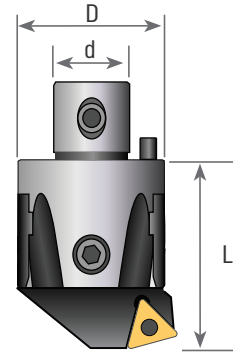

## 75° ULTRAFINE FINISHING HEADS INTEGRAL POCKET TYPE

Part No.	Description	Min	Max	D	d	L	Insert	Screw
6275253	A-22-75-310 W	.945"	1.181"	22	12	1.39"	TP_1.8(1.5)	6811250
6275258	A-27-75-310 W	1.142"	1.575"	27	15	1.65"	TP_1.8(1.5)	6811260
6275263	A-32-75-310 W	1.535"	1.969"	32	18	1.77"	TP_1.8(1.5)	6811260
6275271	A-42-75-311 W	1.929"	2.559"	42	24	2.20"	TP_221	6811262
6275276	A-54-75-311 W	2.48"	3.228"	54	28	2.59"	TP_221	6811262

## 75° ULTRAFINE FINISHING HEADS CARTRIDGE TYPE

Part No.	Description	Min	Max	D	d	L	Cartridge	Screw
6275281	A-68-75-2CT-311 W	3.15"	4.016"	68	36	3.39"	2CT 75 311	6811262
6275296	A-85-75-3CT-311 W	3.94"	4.921"	85	50	3.94"	3CT 75 311	6811266
6275311	A-100-75-3CT-311 W	4.92"	6.299"	110	60	3.94"	3CT 75 311	6811270
6275326	A-200-75-3CT-311 W	6.29"	8.66"	145	60	3.94"	3CT 75 311	6811262

## 75° ULTRAFINE LARGE FINISHING HEADS

Part No.	Description	Min	Max	D	d	L	Cartridge	Screw
6275341	A-300-75-3CT-311 W	8.661"	12.598"	202	60	3.54"	3CT 75 311	6811262
6275356	A-400-75-3CT-311 W	11.417"	15.748"	272	60	3.54"	3CT 75 311	6811266
6275371	A-500-75-3CT-311 W	14.566"	19.685"	2352	60	3.54"	3CT 75 311	6811270

Note: All wrenches are included with each boring head. No special tools are needed. Metric heads are available on request.



Uses ISO standard inserts

UltraFINE finish heads feature an 11° relief angle that provides an ultra-smooth finish, reducing the need for extra operations.

## FEATURES

- AccuSET slide includes graduated dial for fast adjustments in 0.0001" increments
- Manufactured from top quality steel alloy, hardened to 58-60 HRC to minimize wear
- Pin-and-taper coupling system ensures maximum rigidity

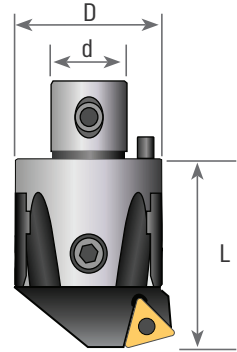

## 90° ULTRAFINE FINISHING HEADS INTEGRAL POCKET TYPE

Part No.	Description	Min	Max	D (mm)	d (mm)	L	Insert	Screw
6390253	A-22-90-310 W	.945"	1.181"	22	12	1.39"	TP_1.8(1.5)	6811250
6390258	A-27-90-310 W	1.142"	1.575"	27	15	1.65"	TP_01.8(1.5)	6811260
6390266	A-32-90-310 W	1.535"	1.969"	32	18	1.77"	TP_1.8(1.5)	6811260
6390276	A-42-90-311 W	1.929"	2.559"	42	24	2.20"	TP_221	6811262
6390291	A-54-90-311 W	2.48"	3.228"	54	28	2.59"	TP_221	6811262

## 90° ULTRAFINE FINISHING HEADS CARTRIDGE TYPE

Part No.	Description	Min	Max	D (mm)	d (mm)	L	Cartridge	Screw
6390306	A-68-90-2CT-311 W	3.15"	4.016"	68	36	3.39"	2CT 90 311	6811262
6390321	A-85-90-3CT-311 W	3.94"	4.921"	85	50	3.94"	3CT 90 311	6811266
6390336	A-100-90-3CT-311 W	4.92"	6.299"	110	60	3.94"	3CT 90 311	6811270
6390351	A-200-90-3CT-311 W	6.29"	8.66"	145	60	3.94"	3CT 90 311	6811262

## 90° ULTRAFINE LARGE FINISHING HEADS

Part No.	Description	Min	Max	D (mm)	d (mm)	L	Cartridge	Screw
6390366	A-300-90-3CT-311 W	8.661"	12.598"	202	60	3.54"	3CT 90 311	6811262
6390381	A-400-90-3CT-311 W	11.417"	15.748"	272	60	3.54"	3CT 90 311	6811266
6390396	A-500-90-3CT-311 W	14.566"	19.685"	2352	60	3.54"	3CT 90 311	6811270

Note: All wrenches are included with each boring head. No special tools are needed.

Metric heads are available on request.



## FEATURES

- Change lead angle or insert style by simply changing cartridges
- Precision ground accuracy
- Symmetrical or staggered boring



75° type 300



75° type 402



## 75° LEAD ANGLE CARTRIDGES FOR SYMMETRICAL BORING

Part No.	Description	Insert	1	2	3	4	5	6	7
6675125	2CT-75-300	TCMT 32.5_	D-68-29	A-68-26	D-68-28	H5	H2	6811260	9355555
6675130	2CT-75-402	CCMT 43_	D-68-29	A-68-26	D-68-28	H5	H2	6811266	9355666
6675135	2CT-75-402N	CNMG 43_	D-68-29	A-68-26	D-68-28	H5	H2	6811270	9322116
6675140	3CT-75-300	TCMT 32.5_	D-85-29	D-85-27	D-68-28	H5	H3	6811262	9355555
6675145	3CT-75-402	CCMT 43_	D-85-29	D-85-27	D-68-28	H5	H3	6811266	9355666
6675150	3CT-75-402N	CNMG 43_	D-85-29	D-85-27	D-68-28	H5	H3	6811270	9322116

## 75° ULTRAFINE LEAD ANGLE CARTRIDGES FOR SYMMETRICAL BORING

Part No.	Description	Insert	1	2	3	4	5	6	7
6675126	2CT-75-311	TCMT 09T3_	D-68-29	A-68-26	D-68-28	H5	H2	6811260	T10
6675141	3CT-75-311	CCMT 1204_	D-85-29	A-68-27	D-68-28	H5	H3	6811266	T10

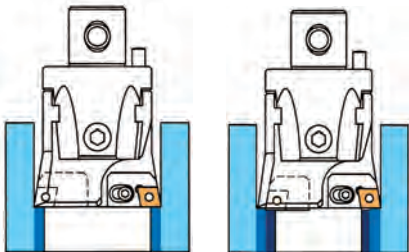

symmetrical boring

staggered boring

Staggered boring is possible by substituting a staggered cartridge in place of the regular cartridge.

This .020" of axial stagger will accommodate most staggered, or "stepped" boring processes.



## FEATURES

- Change lead angle or insert style by simply changing cartridges
- Precision ground accuracy
- Symmetrical or staggered boring



90° type 300



90° type 402



## 90° LEAD ANGLE CARTRIDGES FOR SYMMETRICAL BORING

Part No.	Description	Insert	1	2	3	4	5	6	7
6690125	2CT-90-300	TCMT 32.5_	D-68-29	A-68-26	D-68-28	H5	H2	6811260	9355555
6690130	2CT-90-402	CCMT 43_	D-68-29	A-68-26	D-68-28	H5	H2	6811266	9355666
6690135	2CT-90-402N	CNMG 43_	D-68-29	A-68-26	D-68-28	H5	H2	6811270	9322116
6690140	3CT-90-300	TCMT 32.5_	D-85-29	D-85-27	D-68-28	H5	H3	6811262	9355555
6690145	3CT-90-402	CCMT 43_	D-85-29	D-85-27	D-68-28	H5	H3	6811266	9355666
6690150	3CT-90-402N	CNMG 43_	D-85-29	D-85-27	D-68-28	H5	H3	6811270	9322116

## 90° ULTRAFINE LEAD ANGLE CARTRIDGES FOR SYMMETRICAL BORING

Part No.	Description	Insert	1	2	3	4	5	6	7
6690126	2CT-90-311	TCMT 09T3_	D-68-29	A-68-26	D-68-28	H5	H2	6811260	T10
6690141	3CT-90-311	CCMT 1204_	D-85-29	A-68-27	D-68-28	H5	H3	6811266	T10

## 90° LEAD ANGLE CARTRIDGES FOR STAGGERED BORING

Part No.	Description	Insert	1	2	3	4	5	6	7
6690155	2CT-90-300S	TCMT 32.5_	D-68-29	A-68-26	D-68-28	H5	H2	6811260	9355555
6690160	2CT-90-402S	CCMT 43_	D-68-29	A-68-26	D-68-28	H5	H2	6811266	9355666
6690165	2CT-90-402NS	CNMG 43_	D-68-29	A-68-26	D-68-28	H5	H2	6811270	9322116
6690170	3CT-90-300S	TCMT 32.5_	D-85-29	D-85-27	D-68-28	H5	H3	6811262	9355555
6690175	3CT-90-402S	CCMT 43_	D-85-29	D-85-27	D-68-28	H5	H3	6811266	9355666
6690180	3CT-90-402NS	CNMG 43_	D-85-29	D-85-27	D-68-28	H5	H3	6811270	9322116





pg. 204



pg. 206



pg. 216



pg. 229



## FEATURES

- ISO standard inserts
- TCMT, CCMT, CNMG, EPMT, and DCMT
- Use Magia LT-1000 grade inserts for extended insert life in all types of materials

## TECH TIPS

### ROUGHING:

Use the largest available corner radius unless otherwise specified.

### FINISH BORING:

Use the smallest available corner radius to minimize tool deflection.

### BEST FINISH:

Generally start with your feed at 25% of insert nose radius. Optimal speeds and feeds depend upon material, tool overhang, and setup conditions.

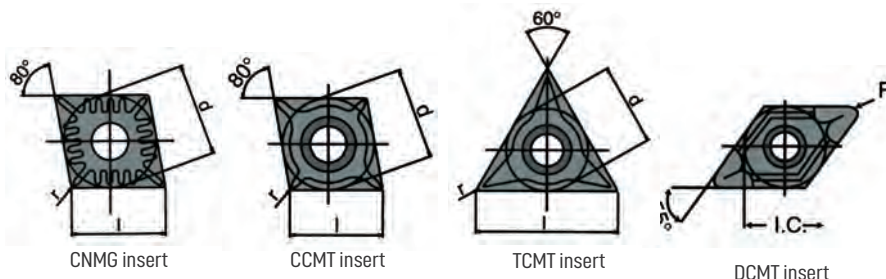

CNMG insert

CCMT insert

TCMT insert

DCMT insert

We recommend LT1000 grade inserts for maximum insert performance. LT1000 grade features an advanced PVD coating that is 14 microns thick and lasts 250% longer than other inserts.

Inserts marked in green are for aluminum & alloys. For extended insert life we recommend LT 1000 grade.

Part No.	Description (ANSI)	Description (ISO)	Grade	l	s	r	Operation
3663336	CCGX 2(1.5)1 LH HP	CCGX 060204 LH	101	0.252	0.094	0.016	General
3663337	CCGX 3(2.5)1 LH HP	CCGX 09T304 LH	101	0.382	0.156	0.016	General
3663338	CCGX 3(2.5)2 LH HP	CCGX 09T308 LH	101	0.382	0.156	0.031	General
3663339	CCGX 432 LH HP	CCGX 120408 LH	101	0.508	0.187	0.031	General
3663311	CCMT 2(1.5)0 HF	CCMT 060202 HF	251	0.252	0.094	0.008	General
3664411	CCMT 2(1.5)1 NN	CCMT 060204 NN	LT 10	0.254	0.094	0.016	General
3668011	CCMT 2(1.5)1 NN	CCMT 060204 NN	LT 1000	0.254	0.094	0.016	General
3663399	CCMT 2(1.5)2 HM	CCMT 060208 HM	251	0.252	0.094	0.031	General
3663344	CCMT 3(2.5)0 HF	CCMT 09T302 HF	251	0.382	0.156	0.008	Finishing
3664413	CCMT 3(2.5)1 NN	CCMT 09T304 NN	LT 10	0.381	0.156	0.016	General
3668021	CCMT 3(2.5)1 NN	CCMT 09T304 NN	LT 1000	0.381	0.156	0.016	General
3664416	CCMT 3(2.5)2 NN	CCMT 09T308 NN	LT 10	0.381	0.156	0.036	General
3668026	CCMT 3(2.5)2 NN	CCMT 09T308 NN	LT 1000	0.381	0.156	0.036	General
3664422	CCMT 431 NN	CCMT 120404 NN	LT 1000	0.508	0.187	0.016	General
3664421	CCMT 431 NN	CCMT 120404 NN	LT 10	0.508	0.187	0.016	General
3664427	CCMT 432 NN	CCMT 120408 NN	LT 1000	0.508	0.187	0.036	General
3664425	CCMT 432 NN	CCMT 120408 NN	LT 10	0.508	0.187	0.036	General
3664429	CCMT 433 NN	CCMT 120412 NN	LT 1000	0.508	0.187	0.047	General
3631083	CCMT 433 NN	CCMT 120412 NN	LT 10	0.508	0.187	0.047	General
6607901	CNGG 431 ALU	CNGG 120404 ALU	LT 05	0.508	0.187	0.016	General
6607905	CNGG 432 ALU	CNGG 120408 ALU	LT 05	0.508	0.187	0.031	General

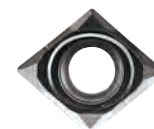

CC\_ \_



CCMT



CN\_ \_

Inserts marked in green are for **aluminum & alloys**.

For extended insert life we recommend LT 1000 grade.

Part No.	Description (ANSI)	Description (ISO)	Grade	l	s	r	Operation
6607029	CNMG 431 NN	CNMG 120404 NN	LT 10	0.508	0.187	0.016	General
6608011	CNMG 431 NN	CNMG 120404 NN	LT 1000	0.508	0.187	0.016	General
6601436	CNMG 432 NM	CNMG 120408 NM	LT 10	0.508	0.187	0.031	Roughing
6601437	CNMG 432 NM	CNMG 120408 NM	LT 1000	0.508	0.187	0.031	Roughing
6607033	CNMG 432 NN	CNM G120408 NN	LT 10	0.508	0.187	0.031	General
6608016	CNMG 432 NN	CNMG 120408 NN	LT 1000	0.508	0.187	0.031	General
6601446	CNMG 432 NR	CNMG 120408 NR	LT 10	0.508	0.187	0.031	Roughing
6608026	CNMG 432 NX	CNMG 120408 NX	LT 1000	0.508	0.187	0.031	General
6607037	CNMG 433 NN	CNMG 120412 NN	LT 10	0.508	0.187	0.047	Roughing
6608021	CNMG 433 NN	CNMG 120412 NN	LT 1000	0.508	0.187	0.047	Roughing
3764421	DCMT 2(1.5)1 NN	DCMT 070304 NN	LT 10	0.305	0.094	0.016	Finishing
3768811	DCMT 2(1.5)1 NN	DCMT 070304 NN	LT 1000	0.305	0.094	0.016	Finishing
3764424	DCMT 3(2.5)1 NN	DCMT 11T304 NN	LT 10	0.458	0.156	0.016	General
3768821	DCMT 3(2.5)1 NN	DCMT 11T304 NN	LT 1000	0.458	0.156	0.016	General
3764427	DCMT 3(2.5)2 NN	DCMT 11T308 NN	LT 10	0.458	0.156	0.031	General
3768826	DCMT 3(2.5)2 NN	DCMT 11T308 NN	LT 1000	0.458	0.156	0.031	General
3732040	DCMT 432 PM4	DCMT 150408 PM4	5615	0.591	0.187	0.031	General
3563336	TCGX21.51 LH HP	TCGX110204 LH HP	101	0.433	0.94	0.016	Finishing
3563337	TCGX32.52 LH HP	TCGX16T308 LH HP	101	0.65	0.156	0.031	General
3533010	TCMT 1.2(1).50 PF4	TCMT 06T102 PF4	5615	0.378	0.094	0.004	Finishing
3533020	TCMT 1.2(1)1 PF4	TCMT 06T104 PF4	5625	0.378	0.094	0.008	Finishing
3563311	TCMT 1.8(1.5)0 HF	TCMT 090202 HF	251	0.378	0.094	0.008	Finishing
3563399	TCMT 1.8(1.5)2 HF	TCMT 090208 HF	251	0.378	0.094	0.016	General
3533033	TCMT 1.8(1.5)1 HM	TCMT 090204 HM	251	0.378	0.094	0.016	General
3533030	TCMT 1.8(1.5)1 PF4	TCMT 090204 PF4	5625	0.378	0.094	0.016	Finishing
3563388	TCMT 1.8(1.5)2 HM	TCMT090208 HM	251	0.378	0.094	0.031	General
3564431	TCMT 2(1.5)1 NN	TCMT 110204 NN	LT 10	0.433	0.094	0.016	Finishing
3568831	TCMT 2(1.5)1 NN	TCMT 110204 NN	LT 1000	0.433	0.094	0.016	Finishing
3564435	TCMT 2(1.5)2 NN	TCMT 110208 NN	LT 10	0.433	0.094	0.031	General
3568841	TCMT 2(1.5)2 NN	TCMT 110208 NN	LT 1000	0.433	0.094	0.031	General
3564438	TCMT 3(2.5)1 NN	TCMT 16T304 NN	LT 10	0.65	0.156	0.016	General
3568851	TCMT 3(2.5)1 NN	TCMT 16T304 NN	LT 1000	0.65	0.156	0.016	General
3564441	TCMT 3(2.5)2 NN	TCMT 16T308 NN	LT 10	0.65	0.156	0.031	General
3568861	TCMT 3(2.5)2 NN	TCMT 16T308 NN	LT 1000	0.65	0.156	0.031	General
3533032	TPGT 1.8(1.5)1-SF	TPGT090204-SF	YNG151C	0.378	0.090	0.016	Finishing
3533033	TPGH 1.8(1.5)0L	TPGH090202	YBG102	0.378	0.090	0.008	Finishing
3533034	TPGH 1.8(1.5)1L	TPGH090204	YBG102	0.378	0.090	0.016	Finishing
3933040	TPGH221L	TPGH110304	YBG102	0.433	0.130	0.016	Finishing



CNMG



DCMT

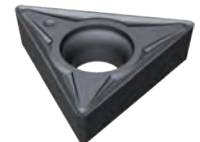

TC\_



Reducers allow different size boring heads to be used with the same toolholder  
Match the d dimension on toolholder and boring head for proper selection.

## FEATURES

- Exceeds industry standards for taper accuracy and concentricity
- Two offset axial tapered locking screws maximize rigidity and allow fast tool changes
- Use extensions to increase boring depth

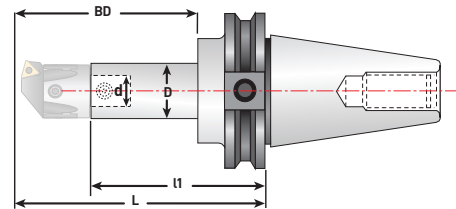

Boring depth (BD) is tool length plus boring head.

## CAT40 BORING TOOLHOLDERS

Part No.	Description	D (mm)	d (mm)	BD	L	l1	Coupling Screw
6133250	CT-340-22-80	22	12	3.150"	4.65"	3.31"	6811510
6133255	CT-340-22-100	22	12	3.937"	5.43"	4.09"	6811510
6133260	CT-340-27-55	27	15	2.165"	3.54"	1.89"	6811520
6133265	CT-340-27-100	27	15	3.937"	5.43"	3.78"	6811520
6133270	CT-340-27-130	27	15	5.118"	6.61"	4.96"	6811520
6133275	CT-340-32-60	32	18	2.362"	3.78"	2.01"	6811530
6133280	CT-340-32-100	32	18	3.937"	5.43"	3.66"	6811530
6133285	CT-340-32-130	32	18	5.118"	6.61"	4.84"	6811530
6133290	CT-340-42-75	42	24	2.953"	4.41"	2.20"	6811540
6133295	CT-340-42-120	42	24	4.724"	5.59"	3.86"	6811540
6134300	CT-340-42-160	42	24	6.300"	7.17"	4.96"	6811540
6134305	CT-340-42-200	42	24	7.874"	8.74"	6.54"	6811540
6134310	CT-340-54-120	54	28	4.724"	5.59"	2.99"	6811550
6134315	CT-340-54-160	54	28	6.300"	7.17"	4.57"	6811550
6134320	CT-340-54-200	54	28	7.874"	8.74"	6.14"	6811550
6134325	CT-340-68-160	68	36	6.300"	7.20"	3.82"	6811560
6134330	CT-340-68-200	68	36	7.874"	8.78"	5.39"	6811560
6134335	CT-340-85-200	85	50	7.874"	8.819"	4.88"	6811570
6134338	CT-340-100-200	100	60	7.874"	8.819"	4.88"	6811580



Reducers allow different size boring heads to be used with the same toolholder. Match the d dimension on toolholder and boring head for proper selection.

## FEATURES

- Exceeds industry standards for taper accuracy and concentricity
- Two offset axial tapered locking screws maximize rigidity and allow fast tool changes
- Use extensions to increase boring depth

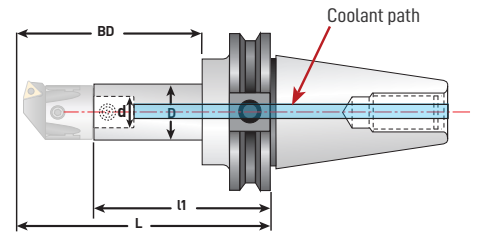

Boring depth (BD) is tool length plus boring head.

## CAT40 COOLANT-THRU

Part No.	Description	D (mm)	d (mm)	BD	L	l1	Coupling Screw
6133257	CT-340-22-100-R	22	12	3.937"	5.43"	4.09"	6811510
6133252	CT-340-22-80-R	22	12	3.150"	4.65"	3.31"	6811510
6133267	CT-340-27-100-R	27	15	3.937"	5.43"	3.78"	6811520
6133272	CT-340-27-130-R	27	15	5.118"	6.61"	4.96"	6811520
6133262	CT-340-27-55-R	27	15	2.165"	3.54"	1.89"	6811520
6133282	CT-340-32-100-R	32	18	3.937"	5.34"	3.66"	6811530
6133287	CT-340-32-130-R	32	18	5.118"	6.61"	4.84"	6811520
6133277	CT-340-32-60-R	32	18	2.362"	3.78"	2.01"	6811530
6133297	CT-340-42-120-R	42	24	4.724"	5.59"	3.39"	6811540
6134302	CT-340-42-160-R	42	24	6.300"	7.17"	4.96"	6811540
6134307	CT-340-42-200-R	42	24	7.874"	8.74"	6.54"	6811540
6133292	CT-340-42-75-R	42	24	2.953"	4.41"	2.20"	6811540
6134312	CT-340-54-120-R	54	28	4.724"	5.59"	2.99"	6811550
6134317	CT-340-54-160-R	54	28	6.300"	7.17"	4.57"	6811550
6134322	CT-340-54-200-R	54	28	7.874"	8.74"	6.14"	6811550
6134327	CT-340-68-160-R	68	36	6.300"	7.20"	3.82"	6811560
6134332	CT-340-68-200-R	68	36	7.874"	8.78"	5.39"	6811560
6134337	CT-340-85-200-R	85	50	7.874"	8.819"	4.88"	6811570
6134340	CT-340-100-200-R	100	60	7.874"	8.819"	4.88"	6811580



Reducers allow different size boring heads to be used with the same toolholder. Match the d dimension on toolholder and boring head for proper selection.

## FEATURES

- Exceeds industry standards for taper accuracy and concentricity
- Two offset axial tapered locking screws maximize rigidity and allow fast tool changes
- Use extensions to increase boring depth

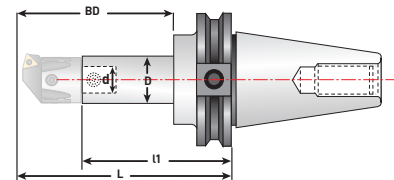

Boring depth (BD) is tool length plus boring head.

## CAT50 BORING TOOLHOLDERS

Part No.	Description	D (mm)	d (mm)	BD	L	l1	Coupling Screw
6141250	CT-350-22-80	22	12	3.150"	4.65"	3.31"	6811510
6141255	CT-350-22-100	22	12	3.937"	5.43"	4.09"	6811510
6141260	CT-350-27-55	27	15	2.165"	3.54"	1.89"	6811520
6141265	CT-350-27-100	27	15	3.937"	5.43"	3.78"	6811520
6141270	CT-350-27-130	27	15	5.118"	6.61"	4.96"	6811520
6141275	CT-350-32-60	32	18	2.362"	3.78"	2.01"	6811530
6141280	CT-350-32-130	32	18	5.118"	6.61"	4.84"	6811530
6141285	CT-350-32-160	32	18	6.299"	7.80"	6.02"	6811530
6141290	CT-350-42-75	42	24	2.953"	4.41"	2.20"	6811540
6141295	CT-350-42-160	42	24	6.299"	7.80"	5.59"	6811540
6141300	CT-350-42-200	42	24	7.874"	9.37"	7.17"	6811540
6141305	CT-350-54-90	54	28	3.543"	5.04"	2.44"	6811550
6141310	CT-350-54-160	54	28	6.299"	7.80"	5.20"	6811550
6141315	CT-350-54-200	54	28	7.874"	9.37"	6.77"	6811550
6141320	CT-350-68-115	68	36	4.528"	5.94"	2.56"	6811560
6141325	CT-350-68-200	68	36	7.874"	8.78"	5.39"	6811560
6141330	CT-350-68-260	68	36	10.236"	11.14"	7.76"	6811560
6141335	CT-350-85-200	85	50	7.874"	8.82"	4.88"	6811570
6141340	CT-350-85-260	85	50	10.236"	11.18"	7.24"	6811570
6141345	CT-350-85-320	85	50	12.598"	13.54"	9.61"	6811570
6141350	CT-350-100-190	100	60	7.480"	8.43"	4.49"	6811580
6141355	CT-350-100-260	100	60	10.236"	11.18"	7.24"	6811580
6141360	CT-350-100-320	100	60	12.598"	13.54"	9.61"	6811580
6166124	CT-550-160*	100	60	4.921"	6.30"	2.76"	6811590



Reducers allow different size boring heads to be used with the same toolholder  
Match the d dimension on toolholder and boring head for proper selection.

## FEATURES

- Exceed industry standards for taper accuracy and concentricity
- Two offset axial tapered locking screws maximize rigidity and allow fast tool changes
- Use extensions to increase boring depth

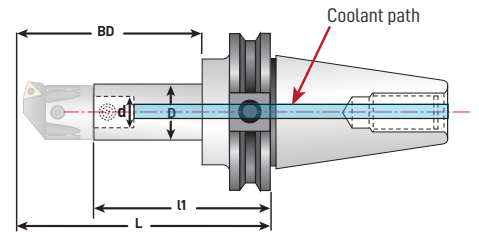

Boring depth (BD) is tool length plus boring head.

## CAT50 COOLANT-THRU

Part No.	Description	D (mm)	d (mm)	BD	L	l1	Coupling Screw
6141252	CT-350-22-80-R	22	12	3.150"	4.65"	3.31"	6811510
6141257	CT-350-22-100-R	22	12	3.937"	5.43"	4.09"	6811510
6141262	CT-350-27-55-R	27	15	2.165"	3.54"	1.89"	6811520
6141267	CT-350-27-100-R	27	15	3.937"	5.43"	3.78"	6811520
6141272	CT-350-27-130-R	27	15	5.118"	6.61"	4.96"	6811520
6141277	CT-350-32-60-R	32	18	2.362"	3.78"	2.01"	6811530
6141282	CT-350-32-130-R	32	18	5.118"	6.61"	4.84"	6811530
6141287	CT-350-32-160-R	32	18	6.299"	7.80"	6.02"	6811530
6141292	CT-350-42-75-R	42	24	2.953"	4.41"	2.20"	6811540
6141297	CT-350-42-160-R	42	24	6.299"	7.80"	5.59"	6811540
6141302	CT-350-42-200-R	42	24	7.874"	9.37"	7.17"	6811540
6141307	CT-350-54-90-R	54	28	3.543"	5.04"	2.44"	6811550
6141312	CT-350-54-160-R	54	28	6.299"	7.80"	5.20"	6811550
6141317	CT-350-54-200-R	54	28	7.874"	9.37"	6.77"	6811550
6141322	CT-350-68-115-R	68	36	4.528"	5.94"	2.56"	6811560
6141327	CT-350-68-200-R	68	36	7.874"	8.78"	5.39"	6811560
6141332	CT-350-68-260-R	68	36	10.236"	11.14"	7.76"	6811560
6141337	CT-350-85-200-R	85	50	7.874"	8.82"	4.88"	6811570
6141342	CT-350-85-260-R	85	50	10.236"	11.18"	7.24"	6811570
6141347	CT-350-85-320-R	85	50	12.598"	13.54"	9.61"	6811570
6141352	CT-350-100-190-R	100	60	7.480"	8.43"	4.49"	6811580
6141362	CT-350-100-320-R	100	60	12.598"	13.54"	9.61"	6811580
6141357	CT-350-100-260-R	100	60	10.236"	11.18"	7.24"	6811580





Reducers allow different size boring heads to be used with the same toolholder. Match the d dimension on toolholder and boring head for proper selection.

## FEATURES

- Exceeds industry standards for taper accuracy and concentricity
- Two offset axial tapered locking screws maximize rigidity and allow fast tool changes
- Use extensions to increase boring depth

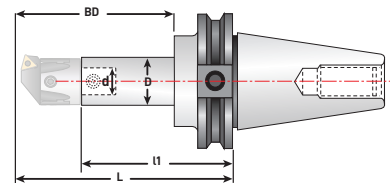

Boring depth (BD) is tool length plus boring head.

## BT30 BORING TOOLHOLDERS

Part-No.	Description	D (mm)	d (mm)	BD	L	l1	Coupling-Screw
6130100	BT-330-22-100	22	12	3.937"	4.92"	3.58"	6811510
6130150	BT-330-27-55	27	15	2.165"	3.03"	1.38"	6811520
6130200	BT-330-27-100	27	15	3.937"	4.92"	3.27"	6811520
6130250	BT-330-32-60	32	18	2.362"	3.27"	1.50"	6811530
6130300	BT-330-32-100	32	18	3.937"	4.92"	3.15"	6811530

## BT40 BORING TOOLHOLDERS

Part-No.	Description	D (mm)	d (mm)	BD	L	l1	Coupling-Screw
6140100	BT-340-22-50	22	12	1.969"	3.15"	1.81"	6811510
6140125	BT-340-22-80	22	12	3.150"	4.33"	2.99"	6811510
6140150	BT-340-22-100	22	12	3.937"	5.12"	3.78"	6811510
6140175	BT-340-27-55	27	15	2.165"	3.23"	1.57"	6811520
6140200	BT-340-27-100	27	15	3.937"	5.12"	3.46"	6811520
6140225	BT-340-27-130	27	15	5.118"	6.30"	4.65"	6811520
6140250	BT-340-32-60	32	18	2.362"	3.46"	1.69"	6811530
6140275	BT-340-32-100	32	18	3.937"	5.12"	3.35"	6811530
6140300	BT-340-32-130	32	18	5.118"	6.30"	4.53"	6811530
6140325	BT-340-42-75	42	24	2.953"	4.09"	1.89"	6811540
6140350	BT-340-42-160	42	24	6.299"	7.48"	5.28"	6811540
6140375	BT-340-42-200	42	24	7.874"	9.06"	6.85"	6811540
6140400	BT-340-54-90	54	28	3.543"	4.72"	2.13"	6811550
6140425	BT-340-54-160	54	28	6.299"	7.48"	4.88"	6811550
6140450	BT-340-54-200	54	28	7.874"	9.06"	6.46"	6811550
6140475	BT-340-68-160	68	36	6.299"	7.13"	3.74"	6811560
6140500	BT-340-68-200	68	36	7.874"	8.70"	5.31"	6811560
6140525	BT-340-85-200	85	50	7.874"	8.66"	4.72"	6811570
6140550	BT-340-100-200	100	60	7.874"	8.66"	4.72"	6811580



Reducers allow different size boring heads to be used with the same toolholder. Match the d dimension on toolholder and boring head for proper selection.

## FEATURES

- Exceed industry standards for taper accuracy and concentricity
- Two offset axial tapered locking screws maximize rigidity and allow fast tool changes
- Use extensions to increase boring depth

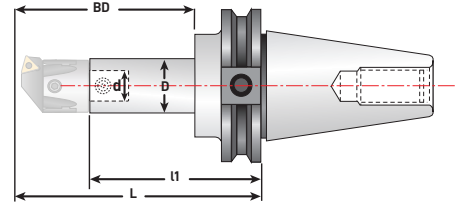

Boring depth (BD) is tool length plus boring head.

## BT50 BORING TOOLHOLDERS

Part No.	Description	D (mm)	d (mm)	BD	L	l1	Coupling Screw
6150100	BT-350-22-80	22	12	3.150"	4.76"	3.43"	6811510
6150125	BT-350-22-100	22	12	3.937"	5.55"	4.21"	6811510
6150150	BT-350-27-55	27	15	2.165"	3.66"	2.01"	6811520
6150175	BT-350-27-100	27	15	3.937"	5.55"	3.90"	6811520
6150200	BT-350-27-130	27	15	5.118"	6.73"	5.08"	6811520
6150225	BT-350-32-60	32	18	2.362"	3.90"	2.13"	6811530
6150250	BT-350-32-130	32	18	5.118"	6.73"	4.96"	6811530
6150275	BT-350-32-160	32	18	6.299"	7.91"	6.14"	6811530
6150300	BT-350-42-75	42	24	2.953"	4.53"	2.32"	6811540
6150325	BT-350-42-160	42	24	6.299"	7.91"	5.71"	6811540
6150350	BT-350-42-200	42	24	7.874"	9.49"	7.28"	6811540
6150375	BT-350-54-90	54	28	3.543"	5.16"	2.56"	6811550
6150400	BT-350-54-160	54	28	6.299"	7.91"	5.31"	6811550
6150425	BT-350-54-200	54	28	7.874"	9.49"	6.89"	6811550
6150450	BT-350-68-115	68	36	4.528"	6.06"	2.68"	6811560
6150475	BT-350-68-200	68	36	7.874"	9.53"	6.14"	6811560
6150500	BT-350-68-260	68	36	10.236"	11.89"	8.50"	6811560
6150525	BT-350-85-200	85	50	7.874"	9.53"	5.59"	6811570
6150550	BT-350-85-260	85	50	10.236"	11.89"	7.95"	6811570
6150575	BT-350-85-320	85	50	12.598"	14.25"	10.31"	6811570
6150600	BT-350-100-170	100	60	6.693"	7.68"	3.74"	6811580
6150625	BT-350-100-260	100	60	10.236"	11.89"	7.95"	6811580
6150650	BT-350-100-320	100	60	12.598"	14.25"	10.31"	6811580
6166123	BT-550-160*	100	60	4.921"	6.30"	2.76"	6811590

\*BT-550-160 is for direct mounting of large heads.



Reducers allow different size boring heads to be used with the same toolholder  
Match the d dimension on toolholder and boring head for proper selection.

## FEATURES

- Two offset axial tapered locking screws maximize rigidity and allow fast tool changes
- Use extensions to increase boring depth

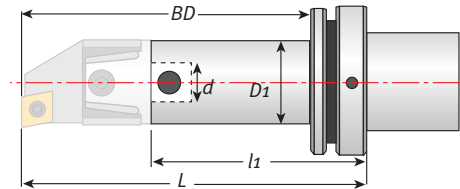

Boring depth (BD) is tool length plus boring head.

## HSK50A BORING TOOLHOLDERS

Part No.	Description	D1 (mm)	d (mm)	BD	L	l1	Coupling Screw
6155501	HSK-50A-22-55	22	12	2.165"	3.19"	1.85"	6811510
6155502	HSK-50A-27-65	27	15	2.559"	3.58"	1.93"	6811520
6155503	HSK-50A-32-75	32	18	2.953"	3.98"	2.20"	6811530
6155504	HSK-50A-42-90	42	24	3.543"	4.57"	2.36"	6811540

## HSK63A BORING TOOLHOLDERS

Part No.	Description	D1 (mm)	d (mm)	BD	L	l1	Coupling Screw
6155631	HSK-63A-22-55	22	12	2.165"	3.19"	1.85"	6811510
6155632	HSK-63A-27-65	27	15	2.559"	3.58"	1.93"	6811520
6155633	HSK-63A-32-75	32	18	2.953"	3.98"	2.20"	6811530
6155634	HSK-63A-42-90	42	24	3.543"	4.57"	2.36"	6811540
6155635	HSK-63A-54-110	54	28	4.331"	5.35"	2.76"	6811550
6155636	HSK-63A-68-145	68	36	5.709"	6.73"	3.35"	6811560

## HSK100A BORING TOOLHOLDERS

Part No.	Description	D1 (mm)	d (mm)	BD	L	l1	Coupling Screw
6155101	HSK-100A-22-55	22	12	2.165"	3.50"	2.165"	6811510
6155102	HSK-100A-27-65	27	15	2.559"	3.90"	2.244"	6811520
6155103	HSK-100A-32-75	32	18	2.953"	4.09"	2.322"	6811530
6155104	HSK-100A-42-90	42	24	3.543"	4.69"	2.480"	6811540
6155105	HSK-100A-54-110	54	28	4.331"	5.47"	2.847"	6811550
6155106	HSK-100A-68-145	68	36	5.709"	6.85"	3.46"	6811560
6155107	HSK-100A-85-165	85	50	6.496"	7.64"	3.70"	6811570
6155108	HSK-100A-100-185	100	60	7.283"	8.43"	4.49"	6811580
6166125	HSK-550-160*	100	60	5.511"	6.692"	3.149"	6811590

\*HSK-550-160 is for direct mounting of large heads.



Match the d dimension on toolholder and boring head for proper selection.

## FEATURES

- Use with any Techniks End Mill Holders with H5 bore tolerance for boring applications from .315" up to 3.228"
- Two offset axial tapered locking screws maximize rigidity and allow fast tool changes

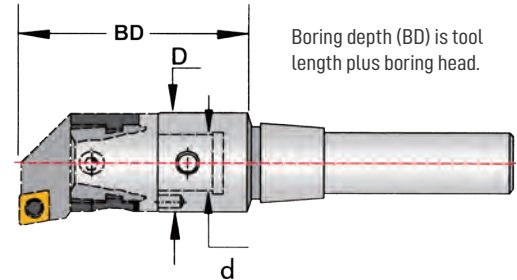

## WELDON 3/4" SHANK

Part No.	Description	D (mm)	d (mm)	BD	Coupling Screws
6165341	B-20-22-50-3/4-SS-WELDON	22	12	1.969"	6811510
6165342	B-20-22-100-3/4-SS-WELDON	22	12	3.937"	6811510
6165343	B-20-54-110-3/4-SS-WELDON	54	28	4.331"	6811550

## WELDON 1" SHANK

Part No.	Description	D (mm)	d (mm)	BD	Coupling Screws
6165101	B-25-27-55-1.0-SS-WELDON	27	15	2.165"	6811520
6165102	B-25-27-100-1.0-SS-WELDON	27	15	3.937"	6811520
6165103	B-25-54-110-1.0-SS-WELDON	54	28	4.331"	6811550

## WELDON 1-1/4" SHANK

Part No.	Description	D (mm)	d (mm)	BD	Coupling Screws
6165141	B-32-32-60-1-1/4-SS-WELDON	32	18	2.362"	6811530
6165142	B-32-32-100-1-1/4-SS-WELDON	32	18	3.937"	6811530
6165143	B-32-42-90-1-1/4-SS-WELDON	42	24	3.543"	6811540
6165144	B-32-54-110-1-1/4-SS-WELDON	54	28	4.331"	6811550

## WELDON 1-1/2" SHANK

Part No.	Description	D (mm)	d (mm)	BD	Coupling Screws
6165121	B-40-42-90-1-1/2-SS-WELDON	42	24	3.543"	6811540
6165122	B-40-42-160-1-1/2-SS-WELDON	42	24	6.299"	6811540
6165123	B-40-54-110-1-1/2-SS-WELDON	54	28	4.331"	6811550

## R8 TOOLHOLDERS

Part No.	Description	D (mm)	d (mm)	BD	Coupling Screws
6165801	R8-22-50-R8	22	12	1.969"	6811510
6165802	R8-27-60-R8	27	15	2.362"	6811520
6165803	R8-32-75-R8	32	18	2.953"	6811530
6165804	R8-42-90-R8	42	24	3.543"	6811540
6165805	R8-54-110-R8	54	28	4.331"	6811550



R8 Tool holder

# LARGE HEAD HOLDERS



## FEATURES

- Maximum rigidity and accuracy
- CAT, BT, HSK100A spindles
- Nickel-chrome alloy steel ensures best reliability and repeatability

Boring depth (BD) is tool length plus boring head.

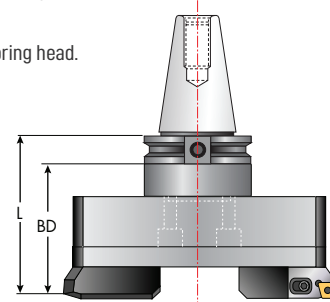

## CAT, BT, HSK DIRECT MOUNT TOOLHOLDERS

Part No.	Description	D	L	lbs
6166124	CAT-550-160-W	3.93"	2.75"	12.45
6166123	BT-550-160	3.93"	2.75"	13.24
6166125	HSK-550-160	3.93"	3.14"	11.55



adapter mount holders  
require 6022510 adapter



optional extension



required adapter

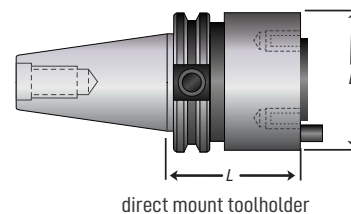

## CAT, BT, HSK100A ADAPTER MOUNT TOOLHOLDERS

Part No.	Description	D	L	lbs
6141350	CAT-350-100-190-W	3.93"	4.48"	14.50
6141355	CAT-350-100-260-W	3.93"	7.24"	24.25
6141360	CAT-350-100-320-W	3.93"	9.60"	32.32
6150600	BT-350-100-170	3.93"	3.74"	12.74
6150625	BT-350-100-260	3.93"	7.95"	27.47
6150650	BT-350-100-320	3.93"	10.31"	35.45
6155108	HSK-100A-100-185	3.93"	4.48"	12.50

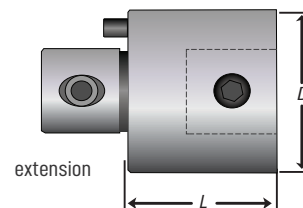
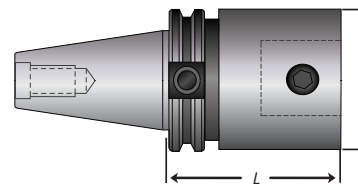

## OPTIONAL EXTENSIONS (REQUIRE ADAPTER FOR LARGE HEAD MOUNTING)

Part No.	Description	D	L	lbs
6551080	P-100-80	3.93"	3.14"	10.10
6551012	P-100-120	3.93"	4.72"	15.56

Extensions can be used with adaptor mount toolholders but do require an adaptor for large head mounting.

## LARGE HEAD ADAPTER (USE WITH ADAPTER MOUNT HOLDERS)

Part No.	Description	D	L	lbs
6022510	ADT-100-50	3.93"	1.96"	9.61

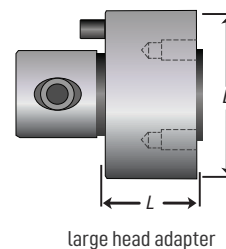

## FINISHING HEADS

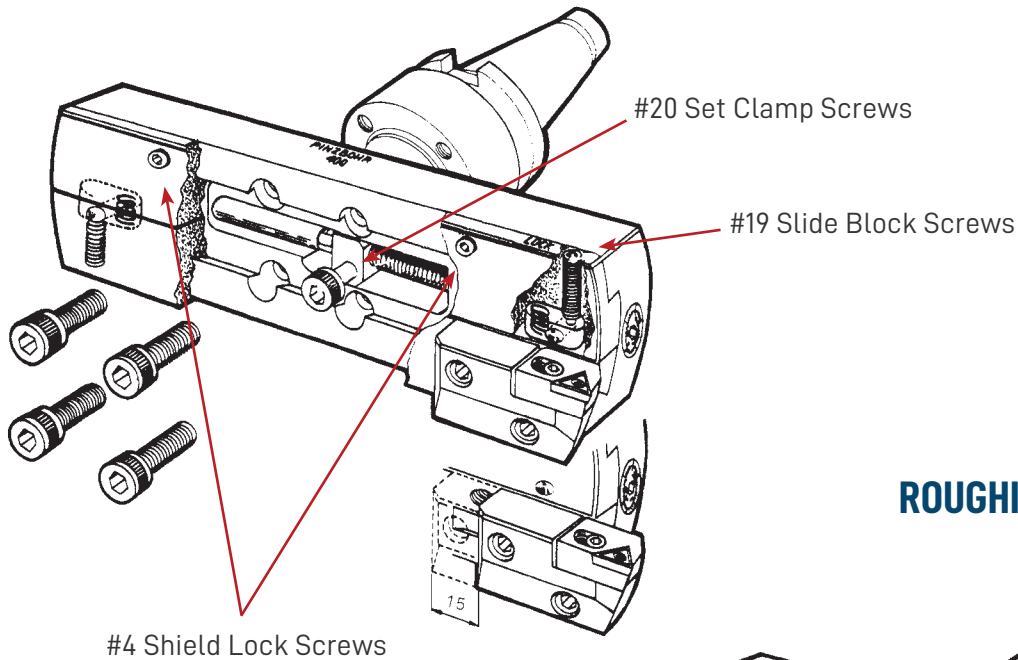

## ROUGHING HEADS

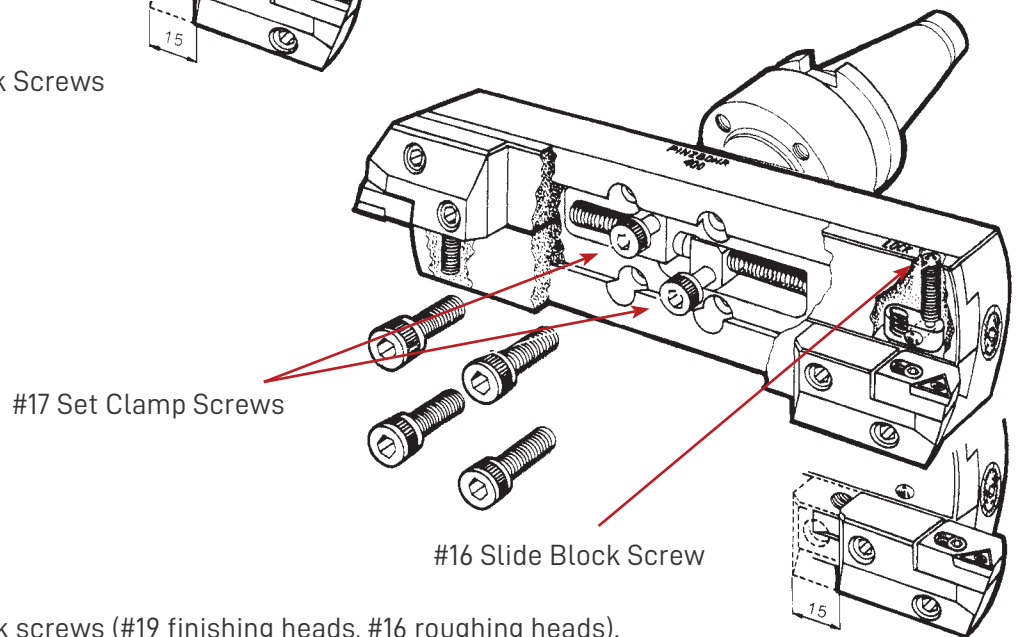

1. Loosen slide block screws (#19 finishing heads, #16 roughing heads).
2. Remove set clamp screws (#20 finishing heads, #17 roughing heads).
3. On finish boring heads only, remove shield lock screws #4.
4. Move slide blocks / shield off-center until the four counter bored bolt holes located in the body below the slide blocks are completely exposed.
5. Place taper shank holder or adapter on back side of boring head with pilot completely engaged in pilot cavity.
6. Insert 4 socket head cap screws into counter bored holes and tighten to 90 ft-lbs torque.
7. Push slide blocks back into position to line up with threaded holes below.
8. Insert nut / close shield lock screws and tighten.
9. Adjust boring head to desired diameter and tighten slide block lock screws.





## FEATURES

- Extend boring depth
- Two offset axial tapered locking screws maximize rigidity and allow fast tool changes

Calculate needed extension length (L) to achieve your boring depth (BD)

## STANDARD EXTENSIONS

Part No.	Description	D (mm)	d (mm)	L	Coupling Screw
6552220	P-22-20	22	12	0.79"	6811510
6552230	P-22-30	22	12	1.18"	6811510
6552730	P-27-30	27	15	1.18"	6811520
6552745	P-27-45	27	15	1.77"	6811520
6553235	P-32-35	32	18	1.38"	6811530
6553252	P-32-52	32	18	2.05"	6811530
6554240	P-42-40	42	24	1.57"	6811540
6554260	P-42-60	42	24	2.36"	6811540
6555450	P-54-50	54	28	1.97"	6811550
6555475	P-54-75	54	28	2.95"	6811550
6556860	P-68-60	68	36	2.36"	6811560
6556890	P-68-90	68	36	3.54"	6811560
6558570	P-85-70	85	50	2.76"	6811570
6558510	P-85-105	85	50	4.13"	6811570
6551080	P-100-80	100	60	3.15"	6811580
6551012	P-100-120	100	60	4.72"	6811580

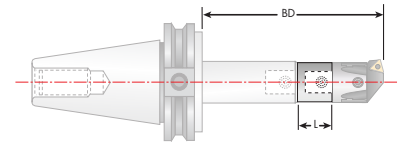

Match the "d" dimensions on toolholder, extension, and boring head for proper selection.

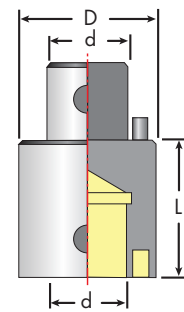

## COOLANT-THRU SPINDLE EXTENSION

The coolant-thru spindle extension provides coolant to the cutting zone for optimal stock removal rates.

Minimum recommend coolant pressure is 70 psi. Coolant is directed onto cutting edge by adapter.

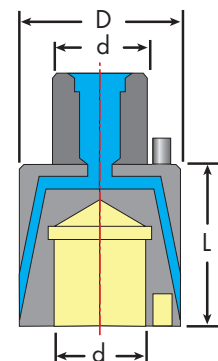

## COOLANT-THRU SPINDLE EXTENSION

Part No.	Description	D (mm)	d (mm)	L	Coupling Screw
6562230	P-22-30R	22	12	1.18"	6811510
6562730	P-27-30R	27	15	1.18"	6811520
6563235	P-32-35R	32	18	1.38"	6811530
6564240	P-42-40R	42	24	1.57"	6811540
6565450	P-54-50R	54	28	1.97"	6811550
6566860	P-68-60R	68	36	2.36"	6811560
6568570	P-85-70R	85	50	2.76"	6811570
6561080	P-100-80R	100	60	3.15"	6811580

Use with coolant-thru toolholders available upon request.

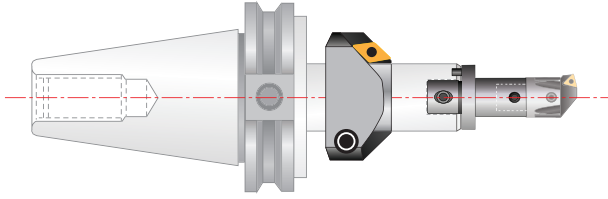

## FEATURES

- Reducers allow different boring heads to be used with the same toolholder / extension combination
- Two offset axial tapered locking screws maximize rigidity and allow fast tool changes

Match the "d" dimensions on toolholder, reducer, and boring head for proper selection.

## 45° CHAMFERING HEADS

Part No.	Desc.	D (mm)	d (mm)	L	Insert	Insert Screw	Wrench	Hex Wrench
6033311	CH-22	43	22	0.94"	DCMT 32.5_	6811260	9355555	4 hex
6033322	CH-27	48	27	0.94"	DCMT 32.5_	6811260	9355555	4 hex
6033333	CH-32	62	32	1.18"	DCMT 32.5_	6811260	9355555	5 hex
6033344	CH-42	72	42	1.18"	DCMT 32.5_	6811260	9355555	5 hex
6033355	CH-54	94	54	1.57"	DCMT 43_	6811266	9355666	6 hex
6033366	CH-68	110	68	1.57"	DCMT 43_	6811266	9355666	8 hex
6033377	CH-85	145	85	2.17"	DCMT 43_	6811266	9355666	10 hex
6033388	CH-100	170	100	2.36"	DCMT 43_	6811266	9355666	14 hex
6033399	CH-200	200	100	2.36"	DCMT 43_	6811266	9355666	14 hex

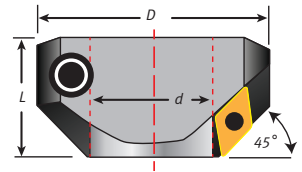

## REDUCERS

Part No.	Description	D (mm)	d (mm)	D1 (mm)	d1 (mm)	L	c	Coupling Screw
6442236	R-27-22-36	27	15	22	12	1.02"	.39"	6811510
6442240	R-32-22-40	32	18	22	12	1.18"	.39"	6811510
6442258	R-42-22-58	42	24	22	12	1.89"	.39"	6811510
6442286	R-54-22-86	54	28	22	12	2.99"	.39"	6811510
6442210	R-68-22-102	68	36	22	12	3.54"	.47"	6811510
6442734	R-32-27-34	32	18	27	15	0.94"	.39"	6811520
6442750	R-42-27-50	42	24	27	15	1.57"	.39"	6811520
6442780	R-54-27-80	54	28	27	15	2.76"	.39"	6811520
6442795	R-68-27-95	68	36	27	15	3.27"	.47"	6811520
6443246	R-42-32-46	42	24	32	18	1.42"	.39"	6811530
6443276	R-54-32-76	54	28	32	18	2.60"	.39"	6811530
6443290	R-68-32-90	68	36	32	18	3.07"	.47"	6811530
6444270	R-54-42-70	54	28	42	24	2.36"	.39"	6811540
6444282	R-68-42-82	68	36	42	24	2.76"	.47"	6811540
6444295	R-85-42-95	85	50	42	24	3.27"	.47"	6811540
6445472	R-68-54-72	68	36	54	28	2.36"	.47"	6811550
6445490	R-85-54-90	85	50	54	28	3.07"	.47"	6811550
6446810	R-85-68-100	85	50	68	36	3.46"	.47"	6811560
6448510	R-100-85-100	100	60	85	50	3.46"	.47"	6811570

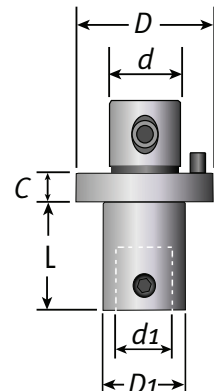



## FEATURES

- For 1/4" up to 3/4" end mills
- Use with extra-long toolholders and extensions for extended length applications
- Two offset center lock screws maximize rigidity while still permitting fast tool changes

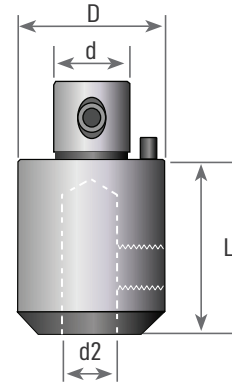

## END MILL HOLDERS

Part No.	Description	D (mm)	d (mm)	L	d2
6123300	ADM-42-W1/4	42	24	1.38"	1/4"
6123305	ADM-42-W3/8	42	24	1.50"	3/8"
6123310	ADM-42-W1/2	42	24	2.17"	1/2"
6123315	ADM-42-W3/4	42	28	2.83"	3/4"
6123320	ADM-54-W3/4	54	28	2.85"	3/4"



## FEATURES

- For 3/4" up to 1-1/4" face mills
- Two offset center lock screws maximize rigidity while still permitting fast tool changes
- Use with extra-long toolholders and extensions for extended length applications

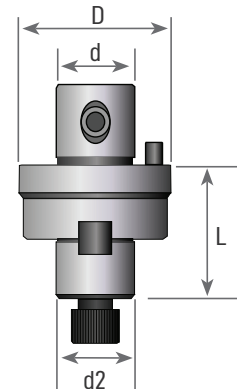

## FACE MILL ARBORS

Part No.	Description	D (mm)	d (mm)	L	d2
6133300	ADM-54-3/4	54	28	1.97"	3/4"
6133305	ADM-54-1.0	54	28	1.97"	1.0"
6133310	ADM-68-1.0	68	36	1.97"	1.0"
6133315	ADM-68-1-1/4	68	36	1.97"	1-1/4"

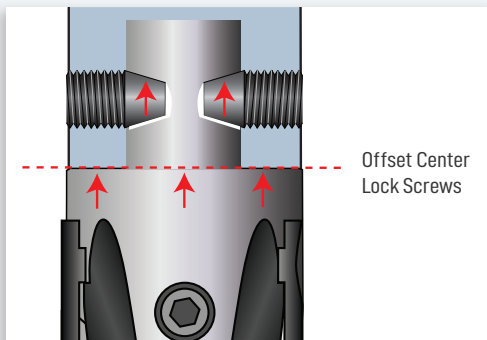

## MODULAR COUPLING SYSTEMS

Our modular coupling system allows heads to be changed without removing tools from the spindle. Two offset center lock screws apply maximum tightening force between the boring head and the toolholder. This increases rigidity and enhances vibration dampening characteristics.



pg. 204



pg. 206



pg. 216



pg. 229

# MACROBOHR MODULAR BORING SYSTEM

## MODULAR BORING SYSTEMS FOR LARGE DIAMETER BORING



**RANGE: 8.661" TO 40.157"**

**FOR FINISH, ROUGH, AND EXTERNAL BORING**

**EASY-TO-USE, NO COMPLICATED SETUPS**

**HARD COATED ALUMINUM AND NICKEL-CHROME ALLOY STEEL  
FOR MAXIMUM ACCURACY AND RIGIDTY**

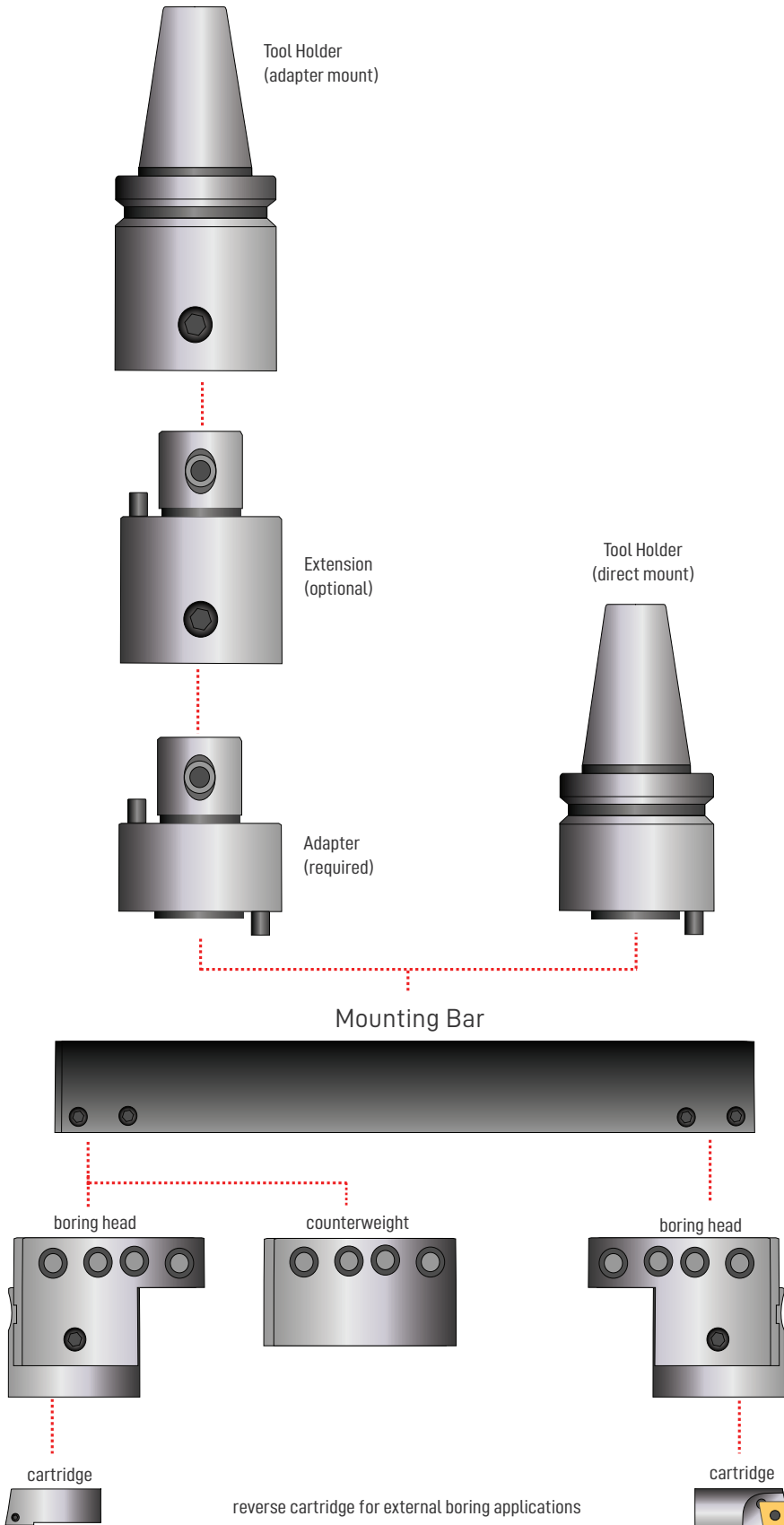

## MACROBOHR MODULAR SYSTEM



The MacroBOHR boring system is a lightweight line of tools optimized for large diameter boring.

MacroBOHR tools are capable of boring holes ranging from 8.661" up to 40.157".

All tool holders, boring heads, & counterweights are made from high-strength aluminum or nickle-chrome alloy steel. The boring heads are fully indexable on the plates and very easy to setup.

## MACROBOHR BORING RANGE



Boring holes from 8.661" up to 40.157" can be achieved by simply changing the plate size. Each plate has 2 radial positions to locate the boring head and counter-weight to achieve minimum or maximum bore size.

Use MacroBOHR for finish, rough, and external boring applications. External boring is achieved by reversing the cartridge position.

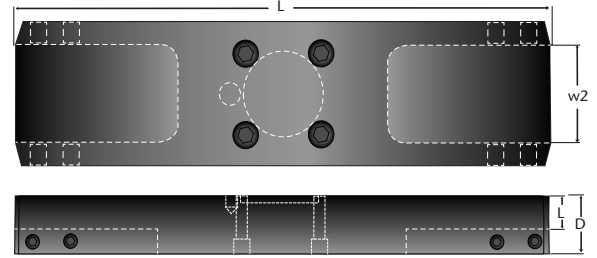

## MOUNTING PLATES

Part No.	Description	Min	Max	L	w2	D	L	lbs	Coupling screw	Qty.	Fixing Screw	Qty.
6921255	MB-SP-0320	8.66"	12.59"	7.87"	3.93"	2.28"	1.22"	4.76	TF 100	4	TC-068-1624	8
6921256	MB-SP-0420	12.59"	16.53"	11.81"	3.93"	2.28"	1.22"	7.21	TF 100	4	TC-068-1624	8
6921257	MB-SP-0520	16.53"	20.47"	15.74"	3.93"	2.28"	1.22"	11.46	TF 101	4	TC-068-1624	8
6921258	MB-SP-0620	20.47"	24.40"	19.68"	3.93"	2.67"	1.61"	18.08	TF 102	4	TC-068-1624	8
6921259	MB-SP-0720	24.40"	28.34"	23.62"	3.93"	2.67"	1.61"	22.27	TF 102	4	TC-068-1624	8
6921260	MB-SP-0820	28.34"	32.28"	27.55"	3.93"	2.67"	1.61"	26.24	TF 102	4	TC-068-1624	8
6921261	MB-SP-0920	32.28"	36.22"	31.49"	3.93"	3.07"	2.00"	35.27	TF 103	4	TC-068-1624	8
6921262	MB-SP-1020	36.22"	40.15"	35.43"	3.93"	3.07"	2.00"	39.90	TF 103	4	TC-068-1624	8



AccuSET graduated dial in 0.0001" increments for fast and easy cutting adjustments.

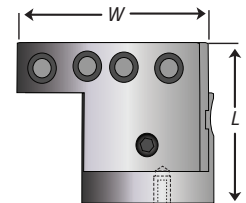
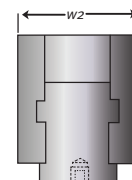

## BORING HEAD

Part No.	Description	W	L	w2	lbs	Cartridge Screw	Adjusting Key	Locking Key
6390410	MB-068-W	4.07"	3.42"	2.67"	6.77	CS 10 25	HK 050	HK 080

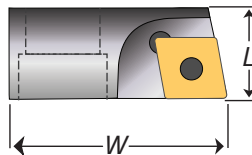

## CARTRIDGES

Part No.	Description	Insert	W	L	lbs	Torx Screw	Torx Key
6690190	TP_22_	TP-1102	2.00"	.78"	0.22	TT 400	TK 08
6922243	TC_32.5_	TC-16T3	2.00"	.78"	0.22	TT 409	TK 15
6921234	CC_32.5_	CC-09T3	2.00"	.78"	0.22	TT 409	TK 15

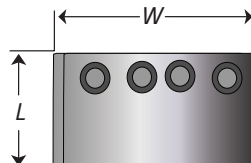

## COUNTERWEIGHT

Part No.	Description	W	L	lbs
6921245	MB-CW	4.07"	2.36"	6.99





## FEATURES

- Maximum rigidity and accuracy
- CAT, BT, HSK100A spindles
- Nickel-chrome alloy steel ensures best reliability and repeatability

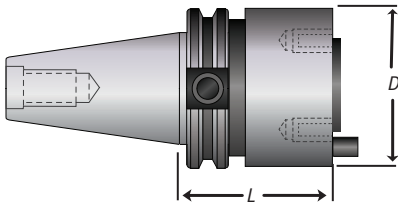

## DIRECT MOUNT TOOLHOLDERS

Part No.	Description	D	L	lbs
6166124	CAT-550-160-W	3.93"	2.75"	12.45
6166123	BT-550-160	3.93"	2.75"	13.24
6166125	HSK-550-160	3.93"	3.14"	11.55

## ADAPTER MOUNT TOOLHOLDERS

Part No.	Description	D	L	lbs
6141350	CAT-350-100-190-W	3.93"	4.48"	14.50
6141355	CAT-350-100-260-W	3.93"	7.24"	24.25
6141360	CAT-350-100-320-W	3.93"	9.60"	32.32
6150600	BT-350-100-170	3.93"	3.74"	12.74
6150625	BT-350-100-260	3.93"	7.95"	27.47
6150650	BT-350-100-320	3.93"	10.31"	35.45
6155108	HSK-100A-100-185	3.93"	4.48"	12.50

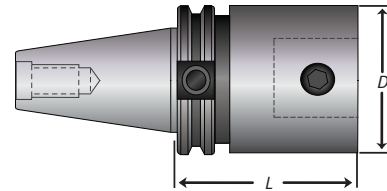

## EXTENSIONS

Part No.	Description	D	L	lbs
6551080	P-100-80	3.93"	3.14"	10.10
6551012	P-100-120	3.93"	4.72"	15.56

(require adapter for large head mounting)

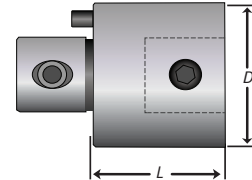

## LARGE HEAD ADAPTER

Part No.	Description	D	L	lbs
6022510	ADT-100-50	3.93"	1.96"	9.61

(use with adapter mount holders)

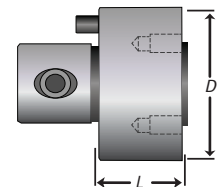

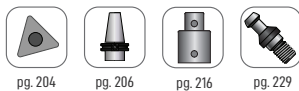

pg. 204

pg. 206

pg. 216

pg. 229

# PINZBOHR SPEEDS & FEEDS GUIDELINES

## ROUGH BORING WITH DUAL INSERTS

Material: Plain Carbon Steel

Dia. Range (inch)	Head Size	Max. Stock Removal on Dia.	Suggested Speeds & Feeds	
			Speed SFM	Feed IPR
.944 - 1.181	22	0.38	320 - 420	.006 - .010
1.141 - 1.574	27	0.47	350 - 450	.006 - .012
1.535 - 1.968	32	0.56	350 - 500	.008 - .012
1.929 - 4.015	42, 54, 68	0.75	350 - 500	.010 - .014
3.935 - 20.00	85, 100, 200	0.84	350 - 500	.012 - .016
	300, 400, 500		350 - 500	.012 - .016

Material: Alloy Steels

.944 - 1.181	22	0.38	300 - 390	.006 - .010
1.141 - 1.574	27	0.47	320 - 420	.006 - .012
1.535 - 1.968	32	0.56	320 - 420	.008 - .012
1.929 - 4.015	42, 54, 68	0.75	320 - 420	.010 - .014
3.935 - 20.00	85, 100, 200	0.84	320 - 420	.012 - .016
	300, 400, 500		320 - 420	.012 - .016

Material: Stainless Steels

.944 - 1.181	22	0.38	200 - 300	.005 - .008
1.141 - 1.574	27	0.47	220 - 320	.006 - .010
1.535 - 1.968	32	0.56	220 - 320	.006 - .010
1.929 - 4.015	42, 54, 68	0.75	220 - 320	.008 - .012
3.935 - 20.00	85, 100, 200	0.84	220 - 320	.010 - .014
	300, 400, 500		220 - 320	.010 - .014

Material: Cast Iron

.944 - 1.181	22	0.38	200 - 350	.008 - .012
1.141 - 1.574	27	0.47	220 - 350	.010 - .014
1.535 - 1.968	32	0.56	220 - 350	.010 - .014
1.929 - 4.015	42, 54, 68	0.75	220 - 350	.012 - .016
3.935 - 20.00	85, 100, 200	0.84	220 - 350	.012 - .018
	300, 400, 500		220 - 350	.012 - .018

Material: Aluminum and Aluminum Alloys

.944 - 1.181	22	0.38	400 - 1000	.008 - .012
1.141 - 1.574	27	0.47	500 - 1200	.010 - .014
1.535 - 1.968	32	0.56	500 - 1200	.010 - .014
1.929 - 4.015	42, 54, 68	0.75	500 - 1200	.012 - .016
3.935 - 20.00	85, 100, 200	0.84	500 - 1200	.012 - .018
	300, 400, 500		500 - 1200	.012 - .018

Material: Titanium and High Temperature Alloys

.944 - 1.181	22	0.25	90 - 120	.005 - .008
1.141 - 1.574	27	0.32	100 - 130	.006 - .010
1.535 - 1.968	32	0.38	100 - 130	.006 - .010
1.929 - 4.015	42, 54, 68	0.50	100 - 130	.008 - .012
3.935 - 20.00	85, 100, 200	0.56	100 - 130	.008 - .014
	300, 400, 500		100 - 130	.008 - .014

## FINISH BORING WITH SINGLE INSERTS

Material: Plain Carbon Steel

Dia. Range (inch)	Head Size	Max. Stock Removal on Dia.	Suggested Speeds & Feeds	
			Speed SFM	Feed IPR
.944 - 1.181	22	.004 - .024	350 - 450	.002 - .006
1.141 - 1.574	27	.004 - .024	380 - 500	.002 - .006
1.535 - 1.968	32	.005 - .030	380 - 500	.002 - .006
1.929 - 4.015	42, 54, 68	.005 - .030	380 - 500	.004 - .008
3.935 - 20.00	85, 100, 200	.006 - .040	380 - 500	.004 - .008
	300, 400, 500	.006 - .040	380 - 500	.004 - .008

Material: Alloy Steels

.944 - 1.181	22	.004 - .024	320 - 420	.002 - .006
1.141 - 1.574	27	.004 - .024	350 - 450	.002 - .006
1.535 - 1.968	32	.005 - .030	350 - 480	.002 - .006
1.929 - 4.015	42, 54, 68	.005 - .030	350 - 480	.004 - .008
3.935 - 20.00	85, 100, 200	.006 - .040	350 - 480	.004 - .008
	300, 400, 500	.006 - .040	350 - 480	.004 - .008

Material: Stainless Steels

.944 - 1.181	22	.010 - .030	220 - 320	.003 - .006
1.141 - 1.574	27	.010 - .030	250 - 350	.003 - .006
1.535 - 1.968	32	.015 - .040	250 - 350	.003 - .006
1.929 - 4.015	42, 54, 68	.015 - .040	250 - 350	.004 - .008
3.935 - 20.00	85, 100, 200	.020 - .050	250 - 350	.005 - .008
	300, 400, 500	.020 - .050	250 - 350	.005 - .008

Material: Cast Iron

.944 - 1.181	22	.010 - .030	220 - 350	.003 - .006
1.141 - 1.574	27	.010 - .030	250 - 380	.003 - .006
1.535 - 1.968	32	.015 - .040	250 - 380	.003 - .006
1.929 - 4.015	42, 54, 68	.015 - .040	250 - 380	.005 - .008
3.935 - 20.00	85, 100, 200	.020 - .050	250 - 380	.005 - .008
	300, 400, 500	.020 - .050	250 - 380	.005 - .008

Material: Aluminum and Aluminum Alloys

.944 - 1.181	22	.010 - .030	500 - 1000	.002 - .006
1.141 - 1.574	27	.010 - .030	500 - 1200	.004 - .008
1.535 - 1.968	32	.015 - .040	500 - 1200	.004 - .008
1.929 - 4.015	42, 54, 68	.015 - .040	500 - 1200	.004 - .008
3.935 - 20.00	85, 100, 200	.020 - .050	500 - 1200	.004 - .010
	300, 400, 500	.020 - .050	500 - 1200	.004 - .010

Material: Titanium and High Temperature Alloys

.944 - 1.181	22	.010 - .030	100 - 130	.003 - .006
1.141 - 1.574	27	.010 - .030	100 - 150	.003 - .006
1.535 - 1.968	32	.015 - .040	100 - 150	.003 - .006
1.929 - 4.015	42, 54, 68	.015 - .040	100 - 150	.004 - .008
3.935 - 20.00	85, 100, 200	.020 - .050	100 - 150	.004 - .008
	300, 400, 500	.020 - .050	100 - 150	.004 - .008

# PARTS FOR ROUGHING HEADS



Indexable cartridges and insert screws are on page 202.

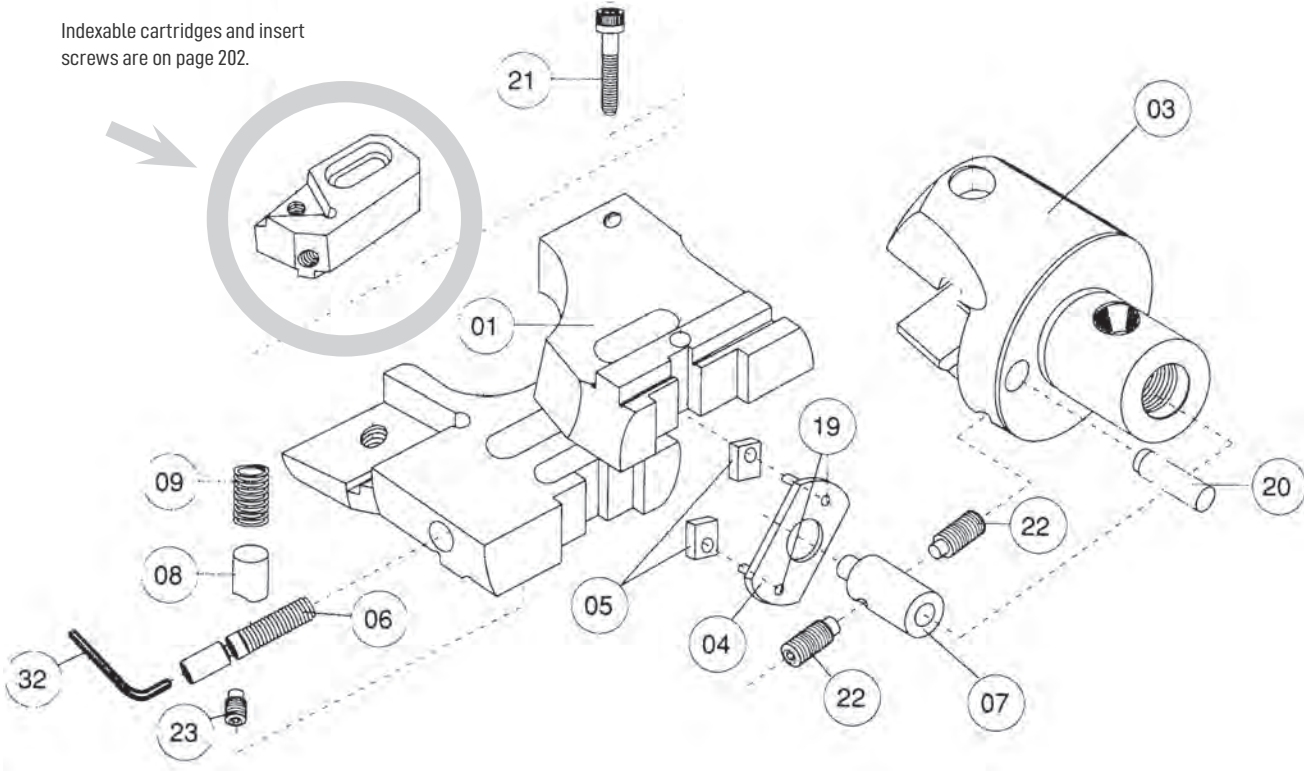

## ROUGHING BORING HEADS **INTEGRAL POCKET**

Boring Heads	01	03	04	05	06	07	08	09	19	20	21	22	23
D 22.75_ _ _	D22.75.01_ _ _	D22 03	D22 04		D22 06	D22 07	D22 08	D22 09	D22 19	D22 20	D22 21	D22 22	D22 23
D 22.90_ _ _	D22.90.01_ _ _	D22 03	D22 04		D22 06	D22 07	D22 08	D22 09	D22 19	D22 20	D22 21	D22 22	D22 23
D 27.75_ _ _	D27.75.01_ _ _	D27 03	D27 04		D27 06	D22 07	D22 08	D27 09	D22 19	D27 20	D27 21	D27 22	D27 23
D 27.90_ _ _	D27.90.01_ _ _	D27 03	D27 04		D27 06	D22 07	D22 08	D27 09	D22 19	D27 20	D27 21	D27 22	D27 23
D 32.75_ _ _W	D32.75.01_ _ _	D32 03W	D32 04		D32 06	D32 07	D32 08	D32 09	D32 19	D32 20	D32 21	D32 22	D32 23
D 32.90_ _ _W	D32.90.01_ _ _	D32 03W	D32 04		D32 06	D32 07	D32 08	D32 09	D32 19	D32 20	D32 21	D32 22	D32 23
D 42.75_ _ _	D42.75.01_ _ _	D42 03	D42 04	D42 05	D42 06	D42 07	D42 08	D42 09	D22 20	D42 20	D42 21	D42 22	D42 23
D 42.90_ _ _	D42.90.01_ _ _	D42 03	D42 04	D42 05	D42 06	D42 07	D42 08	D42 09	D22 20	D42 20	D42 21	D42 22	D42 23
D 54.75_ _ _	D54.75.01_ _ _	D54 03	D54 04	D42 05	D54 06	D54 07	D54 08	D42 09	D22 20	D54 20	D54 21	D54 22	D42 23
D 54.90_ _ _	D54.90.01_ _ _	D54 03	D54 04	D42 05	D54 06	D54 07	D54 08	D42 09	D22 20	D54 20	D54 21	D54 22	D42 23

## ROUGHING BORING HEADS **CARTRIDGE TYPE**

Boring Heads	01	03	04	05	06	07	08	09	19	20	21	22	23
D 68.2CT_ _ _	D68 01 2CT	D68 03	D68 04	D68 05	D68 06	D68 07	D68 08	D68 09	D68 19	D68 20	D68 21	D68 22	D68 23
D 85.3CT_ _ _	D85 01 3CT	D85 03	D85 04	D85 05	D85 06	D85 07	D85 08	D85 09	D85 19	D85 20	D85 21	D85 22	D85 23
D 100.3CT_ _ _	D100 01 3CT	D100 03	D100 04	D85 05	D100 06	D100 07	D100 08	D85 09	D85 19	D100 20	D100 21	D85 22	D85 23
D 200.3CT_ _ _	D200 01 3CT	D200 03	D100 04	D85 05	D200 06	D100 07	D100 08	D85 09	D85 19	D100 20	D100 21	D85 22	D85 23



pg. 204



pg. 206



pg. 216



pg. 229

# PARTS FOR LARGE ROUGHING HEADS

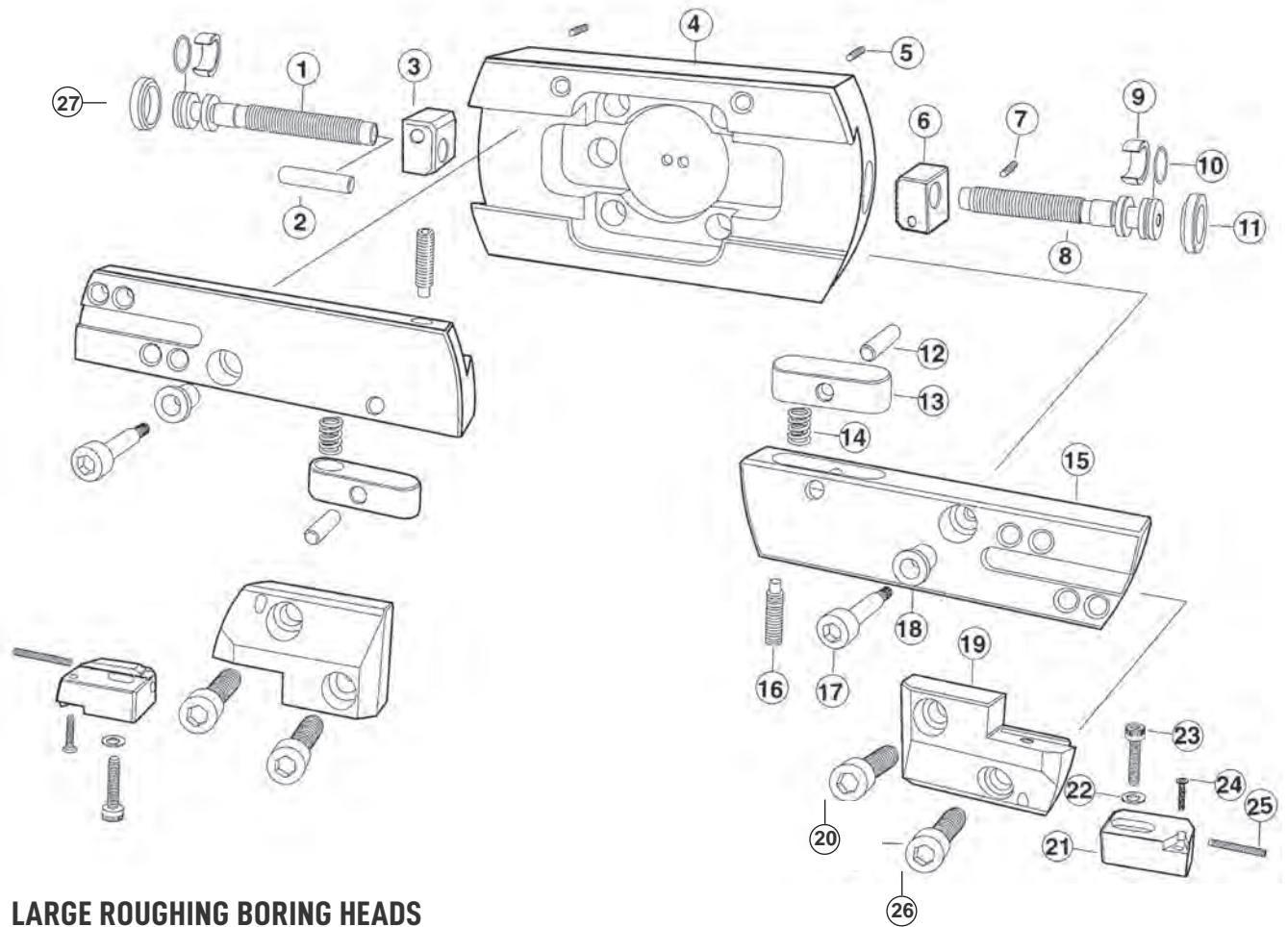

## LARGE ROUGHING BORING HEADS

Roughing Head Reference Number

Spare Part	D 300W	D 400W	D 500W
1	D300.51W	D400.51W	D500.51W
2	D300.66	D300.66	D300.66
3	D300.55W	D300.55W	D300.55W
4	D300.03	D400.03	D500.03
5	D68.23	D68.23	D68.23
6	D300.54W	D300.54W	D300.54W
7	D300.65	D300.65	D300.65
8	D300.50W	D400.50W	D500.50W
9	A68.16	A68.16	A68.16
10	A68.25	A68.25	A68.25
11	D300.15	D300.15	D300.15
12	D300.60	D300.60	D300.60
13	D300.56	D300.56	D300.56

Roughing Head Reference Number

Spare Part	D 300W	D 400W	D 500W
14	D300.59	D300.59	D300.59
15	D300.01	D400.01	D500.01
16	D300.58	D300.58	D300.58
17	D300.57	D300.57	D300.57
18	D300.62	D300.62	D300.62
19	D300.49	D300.49	D300.49
20	D300.61	D300.61	D300.61
21	3CT._____	3CT._____	3CT._____
22	D68.28	D68.28	D68.28
23	D85.27	D85.27	D85.27
24	TT._____	TT._____	TT._____
25	D85.29	D85.29	D85.29
26	D300.67	D300.67	D300.67
27	A68.15	A68.15	A68.15

# PARTS FOR FINISHING HEADS

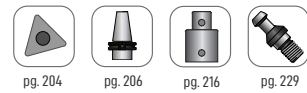

Indexable cartridges and insert screws are on page 202.

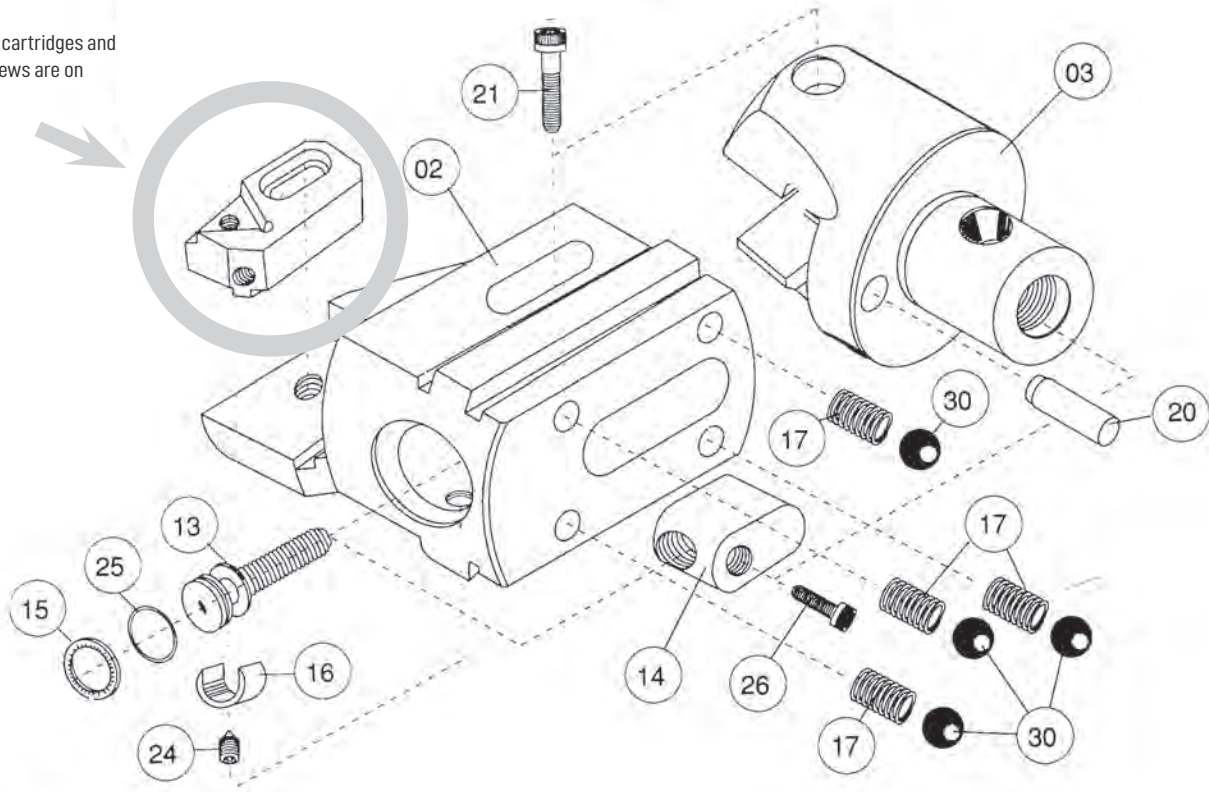

## FINISHING BORING HEADS INTEGRAL POCKET

Boring Head	02	03	13	14	15	16	17	20	21	24	25	26	30
A 22.75__W	A22.75.02__	A22 03	A22 13W	A22 14W	A22 15	A22 16	A22 17	D22 20	D22 21	D22 23	A22 25	A22 26	A22 30
A 22.90__W	A22.90.02__	A22 03	A22 13W	A22 14W	A22 15	A22 16	A22 17	D22 20	D22 21	D22 23	A22 25	A22 26	A22 30
A 27.75__W	A27.75.02__	A27 03	A27 13W	A27 14W	A27 15	A27 16	A27 17	D27 20	D27 21	D27 23	A22 25	A27 26	A27 30
A 27.90__W	A27.90.02__	A27 03	A27 13W	A27 14W	A27 15	A27 16	A27 17	D27 20	D27 21	D27 23	A22 25	A27 26	A27 30
A 32.75__W	A32.75.02__	A32 03W	A32 13W	A32 14W	A32 15	A32 16	A27 17	D32 20	D32 21	D32 23	A22 25	A32 26	A27 30
A 32.90__W	A32.90.02__	A32 03W	A32 13W	A32 14W	A32 15	A32 16	A27 17	D32 20	D32 21	D32 23	A22 25	A32 26	A27 30
A 42.75__W	A42.75.02__	A42 03	A42 13W	A42 14W	A42 15	A42 16	A42 17	D42 20	D42 21	D42 23	A42 25	A42 26	A42 30
A 42.90__W	A42.90.02__	A42 03	A42 13W	A42 14W	A42 15	A42 16	A42 17	D42 20	D42 21	D42 23	A42 25	A42 26	A42 30
A 54.75__W	A54.75.02__	A54 03	A54 13W	A54 14W	A42 15	A42 16	D42 09	D54 20	D54 21	D42 23	A42 25	A42 26	A54 30
A 54.90__W	A54.90.02__	A54 03	A54 13W	A54 14W	A42 15	A42 16	D42 09	D54 20	D54 21	D42 23	A42 25	A42 26	A54 30

## FINISHING BORING HEADS CARTRIDGE TYPE

Boring Head	02	03	13	14	15	16	17	20	21	24	25	26	30
A 68.2CT__W	A68 02 2CT	A68 03	A68 13W	A68 14W	A68 15	A68 16	A68 17	D68 20	D68 21	D68 23	A68 25	A68 26	A68 30
A 85.3CT__W	A85 02 3CT	A85 03	A85 13W	A85 14W	A85 15	A85 16	D85 09	D85 20	D85 21	D85 23	A85 25	A85 26	A85 30
A 100.3CT__W	A100 02 3CT	A100 03	A85 13W	A85 14W	A85 15	A85 16	D85 09	D100 20	D100 21	D85 23	A85 25	A85 26	A85 30
A 200.3CT__W	A200 02 3CT	A200 03	A200 13W	A85 14W	A85 15	A85 16	D85 09	D100 20	D100 21	D85 23	A85 25	A85 26	A85 30





pg. 204



pg. 206



pg. 216



pg. 229

# PARTS FOR LARGE FINISHING HEADS

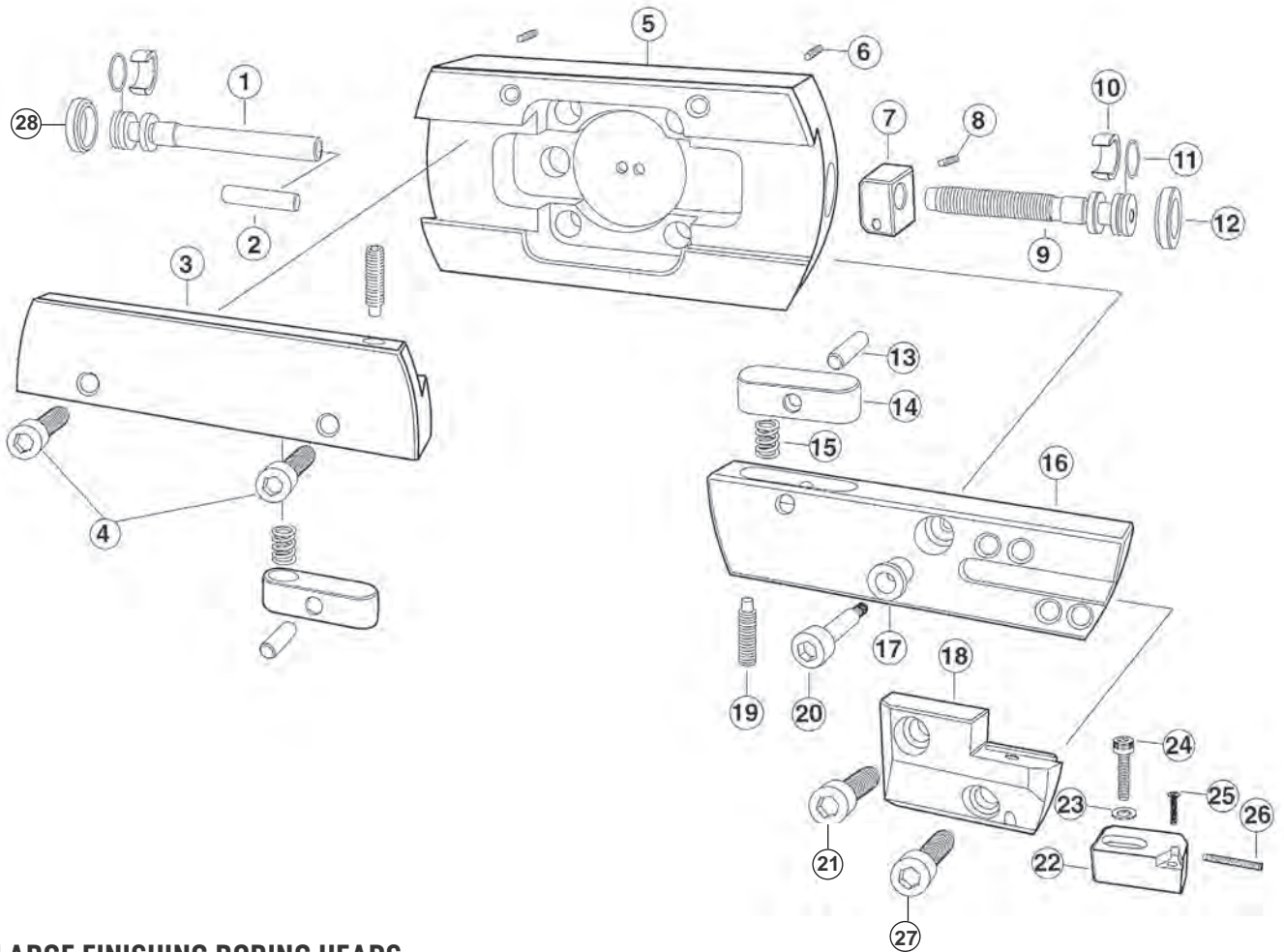

## LARGE FINISHING BORING HEADS

Spare Part	Finishing Head Reference Number		
	A 300W	A 400W	A 500W
1	A300.52W	A300.52W	A300.52W
2	D 300.66	D 300.66	D 300.66
3	A 300.02	A400.02	A500.02
4	A300.63	A300.63	A300.63
5	D300.03	D400.03	D500.03
6	D68.23	D68.23	D68.23
7	D300.54W	D300.54W	D300.54W
8	D300.65	D300.65	D300.65
9	D300.50W	D300.50W	D300.50W
10	A68.16	A68.16	A68.16
11	A68.25	A68.25	A68.25
12	D300.15	D300.15	D300.15
13	D300.60	D300.60	D300.60
14	D300.56	D300.56	D300.56

Spare Part	Finishing Head Reference Number		
	A 300W	A 400W	A 500W
15	D300.59	D300.59	D300.59
16	D300.001	D400.001	D500.001
17	D300.62	D300.62	D300.62
18	D300.49	D300.49	D300.49
19	D300.58	D300.58	D300.58
20	D300.57	D300.57	D300.57
21	D300.61	D300.61	D300.61
22	3CT_-----	3CT_-----	3CT_-----
23	D68.28	D68.28	D68.28
24	D85.27	D85.27	D85.27
25	TT_-----	TT_-----	TT_-----
26	D85.29	D85.29	D85.29
27	D300.67	D300.67	D300.67
28	A68.15	A68.15	A68.15



# PINZBOHR BORING TOOL SELECTION GUIDE



Use the questions below to determine your tooling requirements. You can also fill out and fax this information to us if you need assistance with your tooling selection. Email us at: [info@technikusa.com](mailto:info@technikusa.com)

Name \_\_\_\_\_

Company \_\_\_\_\_

Address \_\_\_\_\_

City \_\_\_\_\_ St \_\_\_\_\_ Zip \_\_\_\_\_

E-mail \_\_\_\_\_ Ph \_\_\_\_\_ Fax \_\_\_\_\_

1. What is the finish size of the hole? \_\_\_\_\_

(Determines size of boring head.)

2. What is the tolerance of the finished hole? \_\_\_\_\_

(Determines if you need rough or finish boring head.)

3. Is the starting hole forged, cast, drilled, or reamed? \_\_\_\_\_

(Determines whether you need 75 or 90 degree boring head.)

4. What is the design of the bored hole? \_\_\_\_\_

(Also determines degree of boring head.)

a. Stepped bore

b. Thru bore \_\_\_\_\_

5. What material are you machining? \_\_\_\_\_

(Determines insert grade and chip breaker selection.)

6. What spindle type is on the machine? \_\_\_\_\_

(Determines holder selection.)

7. How deep is the bore? \_\_\_\_\_

(Determines length of holder and extensions.)

8. Do you require any extra reach for fixturing or other reasons? \_\_\_\_\_

9. Does your machine have coolant-thru capability? \_\_\_\_\_

Misc: Select coolant option based on connection diameter and bore depth requirements (question #6 above).

## KEY TO BORING HEAD DESCRIPTIONS

**A 22 75 400** A = finish heads, D = rough heads  
(see question #2 above)

**22** = connection diameter  
(see question #1 above)

**75** = approach angle  
(see question #3 above)

**400** = insert style or CT cartridge  
(see question #5 above)



## KEY TO BORING TOOLHOLDER DESCRIPTIONS

**CT 330 or 350 22 100**

**CT** = type of spindle (see question #6 above)

**330** = taper size (see question #6 above)

**22** = connection diameter  
(match head connection)

**100** = boring depth (BD)  
(see question #7 above)





# TECHNIKS RETENTION KNOBS

## QUALITY & PERFORMANCE GUARANTEED

**NEW**



### MegaFORCE

MEGAFORCE HIGH-TORQUE RETENTION KNOBS  
SUPERIOR PERFORMANCE AND SAFETY!

#### FEATURES

- Rolled threads maintain material grain structure improving thread strength up to 20%
- Each MegaFORCE Retention knob is magnetic particle tested to ensure material integrity and physical soundness
- Tested at 2.5X the pulling forces of the drawbar



TECHNIKS RETENTION KNOBS

# THE RIGHT CONNECTION

#### FEATURES

- All mating surfaces precision ground
- Manufactured from aircraft quality AMS-6274 alloy steel
- Hardened for maximum longevity

# MEGAFORCE RETENTION KNOBS



## FEATURES

- Rolled threads maintain material grain structure improving thread strength up to 20%
- Each MegaFORCE Retention knob is magnetic particle tested to ensure material integrity and physical soundness
- Tested at 2.5X the pulling forces of the drawbar

The longer overall length engages threads deeper in the tool holder, reducing taper swelling and maximizing taper/spindle contact for the most rigid connection.

MegaFORCE also features a redesigned, blended radii for improved overall strength, making MegaFORCE the strongest high-torque retention knob in the market.

## CAT40/50 ANSI/ISO MEGAFORCE RETENTION KNOBS

Part No.	Type	θ	d1	d2	L	l1	l2	T
40NTRK-MF	CAT40 - ANSI	45°	.74"	.49"	1.62"	.64"	.44"	5/8" - 11
40TRK-MF	CAT40 - ANSI Coolant-Through	45°	.74"	.49"	1.62"	.64"	.44"	5/8" - 11
50NTRK-MF	CAT50 - ANSI	45°	1.14"	.82"	2.3"	1"	.7"	1" - 8
50TRK-MF	CAT50 - ANSI Coolant-Through	45°	1.14"	.82"	2.3"	1"	.7"	1" - 8
M50TRK-MF	CAT50 - ANSI Coolant-Through Mazak O-ring Seal Groove	45°	1.14"	.82"	2.58"	1"	.7"	1" - 8

## CAT40/50 DIN MEGAFORCE RETENTION KNOBS

Part No.	Type	θ	d1	d2	L	l1	l2	T
4008TRK-MF	CAT40 - DIN	75°	.748"	.551"	2.126"	1.024"	.787"	5/8" - 11
4008TRKC-MF	CAT40 - DIN Coolant-Through	75°	.748"	.551"	2.126"	1.024"	.787"	5/8" - 11
4030TRK-MF	CAT40 - DIN Coolant-Through	75°	.748"	.551"	2.126"	1.024"	.787"	5/8" - 11
5030TRK-MF	CAT50 - DIN Coolant-Through	75°	1.102"	.827"	2.913"	1.339"	.984"	1" - 8

Standard Knob

MegaFORCE

### MEGAFORCE VS STANDARD RETENTION KNOBS

**SUPERIOR PERFORMANCE AND SAFETY!**

- The blended radii improves strength
- Pilot provides greater stability
- Deeper thread engagement reduces taper swelling

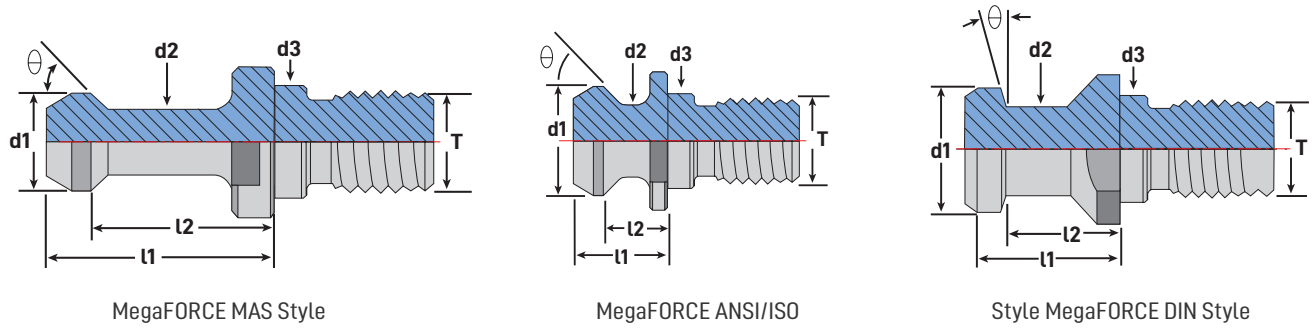

## CAT40/50 MAS MEGAFORCE RETENTION KNOBS

Part No.	Type	$\theta$	d1	d2	L	l1	l2	T
4001TRK-MF	CAT40 - MAS 90°	90°	.591"	.394"	2.250"	1.266"	.990"	5/8" - 11
4005TRKC-MF	CAT40 - MAS 45° Coolant-Through	45°	.591"	.394"	2.250"	1.266"	.990"	5/8" - 11
4005TRK-MF	CAT40 - MAS 45°	45°	.591"	.394"	2.250"	1.266"	.990"	5/8" - 11
4009TRKC-MF	CAT40 - MAS 45° Coolant-Through	45°	.591"	.394"	2.250"	1.266"	.990"	5/8" - 11
4009TRK-MG	CAT40 - MAS 45°	45°	.591"	.394"	2.250"	1.266"	.990"	5/8" - 11
4014TRK-MF	CAT40 - MAS 60°	60°	.591"	.394"	2.250"	1.266"	.990"	5/8" - 11
5001TRKC-MF	CAT50 - MAS 90° Coolant-Through	90°	.906"	.669"	3.354"	1.780"	1.386"	1" - 8
5001TRK-MF	CAT50 - MAS 90°	90°	.906"	.669"	3.354"	1.780"	1.386"	1" - 8
5005TRKC-MF	CAT50 - MAS 45° Coolant-Through	45°	.906"	.669"	3.354"	1.780"	1.386"	1" - 8
5005TRK-MF	CAT50 - MAS 45°	45°	.906"	.669"	3.354"	1.780"	1.386"	1" - 8
5014TRKC-MF	CAT50 - MAS 60° Coolant-Through	60°	.906"	.669"	3.354"	1.780"	1.386"	1" - 8
5014TRCC-MF	CAT50 - MAS 60°	60°	.906"	.669"	3.354"	1.780"	1.386"	1" - 8
MAK050TRK-MF	CAT50 - MAS 45° Makino Coolant-Through	45°	.906"	.669"		1.780"	1.386"	1" - 8
TOY050TRK-MF	CAT50 - MAS 45° Toyoda Coolant-Through	45°	.906"	.669"		1.780"	1.386"	1" - 8

## BT40 DIN MEGAFORCE RETENTION KNOBS

Part No.	Type	$\theta$	d1	d2	L	l1	l2	T
4020TRK-MF	BT40 - MAS 75° Coolant-Through	75°	.748"	.551"	2.126"	1.142"	.906"	M16-2

## BT30/40 MAS MEGAFORCE RETENTION KNOBS

Part No.	Type	$\theta$	d1	d2	L	l1	l2	T
3003TRK-MF	BT30 - MAS 45°	45°						M12-1.75
3004TRK-MF	BT30 - MAS 60°	60°	.433"	.276"	1.693"	.906"	.709"	M12-1.75
4003TRKC-MF	BT40 - MAS 45° Coolant-Through	45°	.591"	.394"	2.362"	1.378"	1.102"	M16-2
4003TRK-MF	BT40 - MAS 45°	45°	.591"	.394"	2.362"	1.378"	1.102"	M16-2
4004TRKC-MF	BT40 - MAS 60° Coolant-Through	60°	.591"	.394"	2.362"	1.378"	1.102"	M16-2

# RETENTION KNOBS



## FEATURES

- All mating surfaces precision ground
- Manufactured from aircraft quality AMS-6274 alloy steel
- Hardened for maximum longevity

Please make sure that the Retention Knob you order is the correct one for your machine. Using the wrong Retention Knob can cause damage to your machine spindle, the toolholder, and may create a safety hazard.

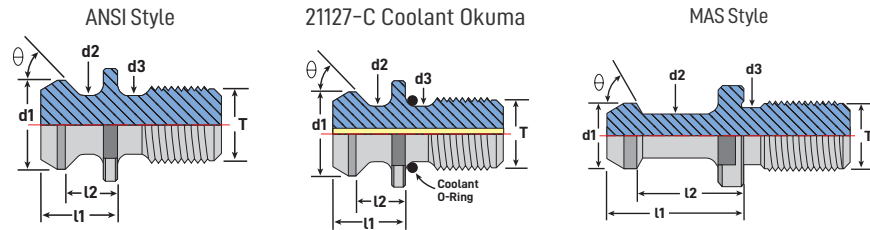

## CAT RETENTION KNOBS

Part No.	Type	$\theta$	d1	d2	d3	l1	l2	T
21006-15	CAT40-DIN	15°	.750"	.550"	.640"	1.024"	.787"	5/8 - 11
21007-15	CAT40-DIN	15°	.750"	.550"	-	1.028"	.792"	5/8 - 11
21003	CAT40-ANSI	45°	.740"	.490"	.490"	.640"	.440"	5/8 - 11
21003-45	CAT40-MAS-I	45°	.590"	.394"	.512"	1.266"	.990"	5/8 - 11
21003-60	CAT40-MAS-II	60°	.590"	.394"	.512"	1.266"	.990"	5/8 - 11
21003-90	CAT40-MAS-III	90°	.590"	.394"	.512"	1.266"	.990"	5/8 - 11
21005-45	CAT50-MAS-I	45°	.906"	.669"	.827"	1.772"	1.378"	1 - 8
21005-60	CAT50-MAS-II	60°	.906"	.669"	.827"	1.772"	1.378"	1 - 8
21005-90	CAT50-MAS-III	90°	.906"	.669"	.827"	1.772"	1.378"	1 - 8
21008-15	CAT50-DIN	15°	1.101"	.825"	-	1.338"	.984"	1 - 8
21005	CAT50-ANSI	45°	1.140"	.820"	.820"	1.000"	.700"	1 - 8

## CAT COOLANT STYLE RETENTION KNOBS

Part No.	Type	$\theta$	d1	d2	d3	l1	l2	T
17836	CAT40, ANSI, w/ metric thread	45°	.740"	.490"	.490"	.630"	.56"	M16
21006-15C	CAT40-DIN Coolant	15°	.750"	.550"	.640"	1.024"	.787"	5/8 - 11
21007-15C	CAT40-DIN Coolant	15°	.750"	.550"	-	1.028"	.792"	5/8 - 11
21148-C	CAT40-Coolant Mori-Seiki	15°	.747"	.548"	.641"	1.024"	.787"	5/8 - 11
21003-C	CAT40-ANSI-C	45°	.740"	.490"	.490"	.640"	.440"	5/8 - 11
21003-45C	CAT40-Coolant-I	45°	.590"	.394"	.512"	1.266"	.990"	5/8 - 11
21127-C	CAT40 - Coolant Okuma	45°	.740"	.490"	.490"	.640"	.440"	5/8 - 11
21003-60C	CAT40-Coolant-II	60°	.590"	.394"	.512"	1.266"	.990"	5/8 - 11
21003-90C	CAT40-Coolant-III	90°	.590"	.394"	.512"	1.266"	.990"	5/8 - 11
21003-45CSF	CAT40-Coolant-I SlimFIT	45°	.590"	.394"	.512"	1.266"	.990"	5/8 - 11
21003-60CSF	CAT40-Coolant-II SlimFIT	60°	.590"	.394"	.512"	1.266"	.990"	5/8 - 11
21003-90CSF	CAT40-Coolant-III SlimFIT	90°	.590"	.394"	.512"	1.266"	.990"	5/8 - 11
21005-45C	CAT50-Coolant-I	45°	.906"	.669"	.827"	1.772"	1.378"	1 - 8
21005-60C	CAT50-Coolant-II	60°	.906"	.669"	.827"	1.772"	1.378"	1 - 8
21005-90C	CAT50-Coolant-III	90°	.906"	.669"	.827"	1.772"	1.378"	1 - 8
21008-15C	CAT50-DIN Coolant	15°	1.101"	.825"	-	1.338"	.984"	1 - 8
21005-C	CAT50-ANSI-C	45°	1.140"	.820"	.820"	1.000"	.700"	1 - 8

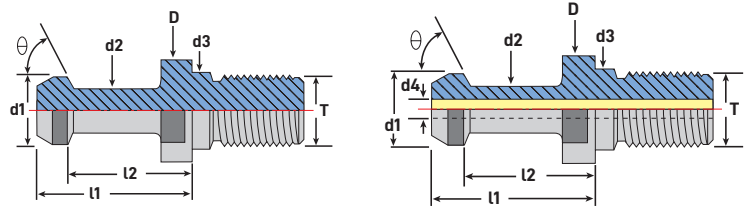

## BT RETENTION KNOBS

Dimensions in millimeters.

Part No.	Description	$\theta$	D	d1	d2	d3	l1	l2	T
17801	BT30 - 45°	45°	16.5	11	7	12.5	23	18	M12
17803	BT40 - 45°	45°	23	15	10	17	35	28	M16
17834	BT40, ANSI, metric thread	45°	23	18.8	12.5	12.4	16	11	M16
17805	BT50 - 45°	45°	38	23	17	25	45	35	M24
17806	BT30 - 60°	60°	16.5	11	7	12.5	23	18	M12
17808	BT40 - 60°	60°	23	15	10	17	35	28	M16
17810	BT50 - 60°	60°	38	23	17	25	45	35	M24
17812	BT30 - 90°	90°	16.5	11	7	12.5	23	8	M12
17814	BT40 - 90°	90°	23	15	10	17	35	28	M16
17816	BT50 - 90°	90°	38	23	17	25	45	35	M24

## BT COOLANT STYLE RETENTION KNOBS

Dimensions in millimeters.

Part No.	Description	$\theta$	D	d1	d2	d3	d4	l1	l2	T
17817	BT30 - 45° coolant	45°	16.5	11	7	12.5	4	23	18	M12
17818	BT40 - 45° coolant	45°	23	15	10	17	4	35	28	M16
17820	BT40 - 60° coolant	60°	23	15	10	17	4	35	28	M16
17822	BT40 - 90° coolant	90°	23	15	10	17	4	35	28	M16
17824	BT50 - 45° coolant	45°	38	23	17	25	5	45	35	M24
17826	BT50 - 60° coolant	60°	38	23	17	25	5	45	35	M24
17828	BT50 - 90° coolant	90°	38	23	17	25	5	45	35	M24



## DIN 69871-A & B RETENTION KNOBS

Dimensions in millimeters.

Part No.	Description	$\theta$	D	d1	d2	d3	d4	l1	l2	l3	SW	T
49001	DAT30-A	15°	17	13	9	13	-	24	19	-	14	M12
49003	DAT40-A	15°	23	19	14	17	7	26	20	-	19	M16
49005	DAT50-A	15°	36	28	21	25	11.5	34	25	-	30	M24
49011	DAT30-B	15°	17	13	9	13	-	24	19	2.3	14	M12
49013	DAT40-B	15°	23	19	14	17	7	26	20	3.0	19	M16
49015	DAT50-B	15°	36	28	21	25	11.5	34	25	4.5	30	M24

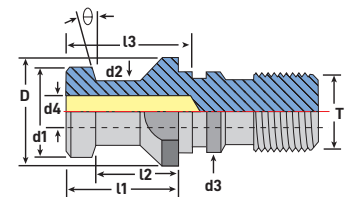

DIN 69871B

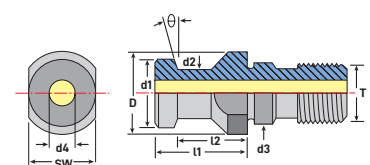

DIN 69871A



# RETENTION KNOBS FOR CNC ROUTERS



## FEATURES

- All mating surfaces precision ground
- Manufactured from aircraft quality AMS-6274 alloy steel
- Hardened for maximum longevity

Match the dimensions and appearance of your retention knob to the drawings below. Use the manufacturer's print that came with your machine to verify your selection.

For safe operation, ensure the pull stud you order is the exact pull stud your machine uses. Using the wrong pull stud can cause damage to the spindle and/or toolholder, and can create a safety hazard.

Dimensions in millimeters.

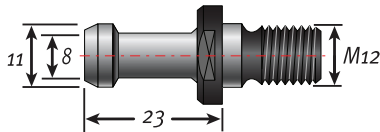

### BT30 - 45°

**PART NO. 07801**

Includes: Heian, Shinx

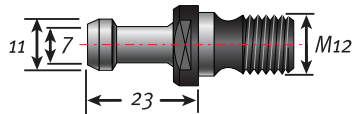

### BT30 - 60°

**PART NO. 07806**

Includes: Shoda, Anderson (1997 and earlier, verify on manufacturer's print)

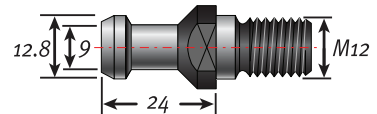

### BT30 KOMO

**PART NO. 750-19**

Only for BT30 KOMO routers

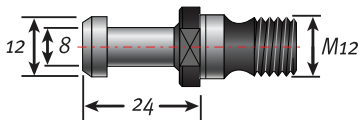

### BT30 - 90°

**PART NO. 07812**

(verify on manufacturer's print)

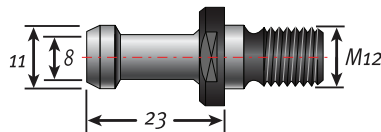

### BT35 - 60°

**PART NO. 4403502**

(Heian, verify on manufacturer's print)

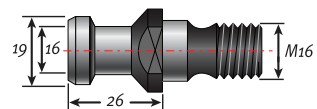

### DAT 40

**PART NO. 49003**

(verify on manufacturer's print)

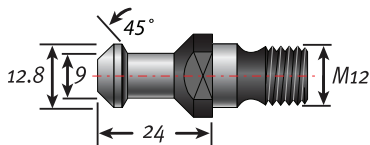

### COLOMBO ISO30 BALL STYLE FOR RS SPINDLES

**PART NO. 49001-45**

Includes: Motion Master (verify on manufacturer's print)

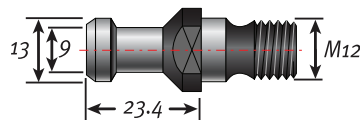

### COLOMBO ISO30 FOR BILLET SPINDLE

**PART NO. 49001**

Includes: Motion Master, Anderson (for newer machines, verify on manufacturer's print)

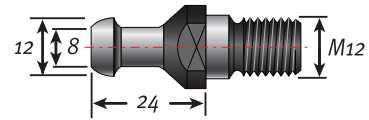

### ISO30 FOR HSD SPINDLES

**PART NO. 49019**

Includes: Biesse, Bermag, Bussellato, CNT, DMS, CR Onsrud, Masterwood, Thermwood, and Holz-her



# TECHNIKS SETUP EQUIPMENT

TIGHTENING FIXTURES | WRENCHES | INDICATOR ARMS

## ADJUSTABLE TORQUE WRENCHES AND ADAPTERS



## TIGHTENING FIXTURES

- For CAT, BT, HSK, ISO & PSC tapers
- Change retention knobs from below



## ECE INDICATOR ARMS

- "One Twist" 360° adjustable joints
- Hydraulic mechanism provides rigid set-up.
- Powerful magnetic base

Indicator Arms are used to check concentricity.  
Dial Indicators not included.



# WRENCHES FOR COLLET NUTS



DNA slotted wrench



ER / TG slotted wrench



ER hex wrench



ER mini wrench



TG hook wrench

Correct torque on the collet nut reduces collet wear and improves safety by properly securing cutting tool in the holder. Use the torque chart on page 72 for tightening collet nuts. Do not overtighten nuts or you may damage the collet and/or toolholder.

## DNA SLOTTED WRENCHES

Part No.	Description
DNA11W	DNA11 Wrench
DNA16W	DNA16 Wrench
DNA20W	DNA20 Wrench
DNA32W	DNA32 Wrench
894-22	DNA 16 Mini-Nut Wrench

## ER HEX NUT WRENCHES

Part No.	Description
894-36	ER32 SuperRIGID Hex Nut Wrench
04608	ER11 Hex Nut Wrench
04609	ER16 Hex Nut Wrench
04610	ER20 Hex Nut Wrench

## ER SLOTTED NUT WRENCHES

Part No.	Description
04613	ER16 Slotted Nut Wrench
04614	ER20 Slotted Nut Wrench
04615	ER25 Slotted Nut Wrench
04616	ER32 Slotted Nut Wrench
04617	ER40 Slotted Nut Wrench
04618	ER50 Slotted Nut Wrench

## ER MINI NUT WRENCHES

Part No.	Description
04620	ER8 Mini Nut Wrench
04621	ER11 Mini Nut Wrench
04622	ER16 Mini Nut Wrench
04623	ER20 Mini Nut Wrench
04624	ER25 Mini Nut Wrench

## TG & SYOZ WRENCHES

Part No.	Description
04018	TG75 Slotted Nut Wrench
83691	TG100/SYOZ 25 Hook Wrench
22220	SYOZ 20 Hook Wrench

## MILLING CHUCK AND DRILL CHUCK WRENCHES

Part No.	Description
83691	1" Milling Chuck Wrench
84193G	1-1/4" Milling Chuck Wrench
82172	Drill Chuck Wrench

# ADJUSTABLE TORQUE WRENCHES & COLLET KEY ADAPTERS



Set adjustable dial to specified torque, and tighten nut until wrench "clicks".



Improved "pull-release" locking system makes locking wrench at correct torque more secure.

## TORQUE WRENCH FEATURES

- Factory calibrated and certified accuracy +/- 3%
- Easy read dial for fast adjustments to torque value
- Improved locking system for a more secure lock

## ADJUSTABLE TORQUE WRENCH

Part No.	Range	Length	Weight	Spigot
50TH	7.5-37.5 ft/lbs	12.5"	1.4 lbs	16mm round
200TH	30-150 ft/lbs	16.5"	1.75 lbs	16mm round
300TH	45-228 ft/lbs	21.5"	2.5 lbs	16mm round



ER Mini



TG Hook



DNA Slotted



ER Hex



ER Slotted



ER Slotted Enclosed

## ER MINI-NUT KEY ADAPTERS

Part No.	Size	Type	Torque
04576	ER11 mini	mini	12 ft/lbs
04577	ER16 mini	mini	20 ft/lbs
04578	ER20 mini	mini	22 ft/lbs
04587	ER25 mini	mini	28 ft/lbs

## ER HEX NUT KEY ADAPTERS

Part No.	Size	Type	Torque
04581	ER11 hex	hex	12 ft/lbs
04601-16	ER16 hex	hex	42 ft/lbs
04602-20	ER20 hex	hex	59 ft/lbs

## TG AND SYOZ NUTS KEY ADAPTERS

Part No.	Size	Type	Torque
04018-TWA	TG 75, 45-50mm	hook	90 ft/lbs
03690-25	TG 100/SYOZ25, 55-60mm	hook	90 ft/lbs
04593	SYOZ-20	hook	40 ft/lbs

## ER SLOTTED NUT KEY ADAPTERS

Part No.	Size	Type	Torque
04581	DNA 11	hex	12 ft/lbs
DNA16TWA	DNA 16	slotted	42 ft/lbs
DNA20TWA	DNA 20	slotted	59 ft/lbs
DNA32TWA	DNA 32	slotted	100 ft/lbs
04588-R	ER 32 Enclosed	slotted	100 ft/lbs
04580-16	ER16 slotted	slotted	42 ft/lbs
04580-20	ER20 slotted	slotted	59 ft/lbs
04603-25	ER25 slotted	slotted	77 ft/lbs
04604-32	ER32 slotted	slotted	100 ft/lbs
04605-40	ER40 slotted	slotted	130 ft/lbs

## RETENTION KNOB SOCKETS SQUARE DRIVE



Part No.	Size	Flats	Drive	Torque
PSS-30BT	BT30	.535"	3/8"	36 ft/lbs
PSS-30ISO	ISO 30	.535"	3/8"	36 ft/lbs
PSS-40	All 40 taper	.750"	3/8"	76 ft/lbs
PSC-50	CAT50, BT50	1.187"	1/2"	100 ft/lbs

## FIXED HEAD SQUARE DRIVES

Part No.	Description	Drive
29828	3/8" square drive	3/8"
29827	1/2" square drive	1/2"



# TIGHTENING FIXTURES



## FEATURES

- For CAT, BT, HSK, ISO spindles
- Auto-locking roller bearing design makes tool changes faster and eliminates slippage.

## ROLLER BEARING TIGHTENING FIXTURE

Part No.	Taper
17846B	CAT40, BT40, HSK63A/E/F, C6, ISO40
17385B	ISO30, SK30, HSK50
17386B	BT30
17386B-35	BT35
17584B	HSK32
17586B	HSK40
17785B	CAT50, BT50
17786B	HSK100
17387B	HSK85 Weining

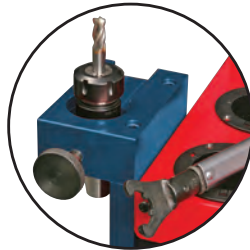

## NTS SIDE MOUNT TIGHTENING FIXTURES

- For CAT, BT, HSK, ISO spindles
- Change retention knobs from bottom
- Bolts right to workbench

NOTE: a sliding collar engages the wrench flats on HSK and toolholders without drive slots.

NOTE: a large set-screw engages the drive slot in BT and CAT holders.

## CAT40 AND BT30 NTS FIXTURES

Part No.	Taper
NTS-40-TAPER	CAT40 or BT40 taper
NTS-BT30-38	BT30 taper - 38mm flats
NTS-BT30-41	BT30 taper - 41mm flats
NTS-BT30-SLOT	BT30 for drive slots

## HSK63 NTS FIXTURES

Part No.	Taper
NTS-HSK63A	HSK63A - no flats
NTS-HSK63F-36	HSK63F - 36mm flats
NTS-HSK63F-38	HSK63F - 38mm flats
NTS-HSK63F-41	HSK63F - 41mm flats
NTS-HSK63F-46	HSK63F - 46mm flats

## ISO NTS FIXTURES

Part No.	Taper
NTS-ISO20-17	ISO 20 - 17mm flats
NTS-ISO20-22	ISO 20 - 22mm flats
NTS-ISO25-27	ISO 25 - 27mm flats
NTS-ISO30-36	ISO 30 - 36mm flats
NTS-ISO30-38	ISO 30 - 38mm flats
NTS-ISO30-47	ISO 30 - 47mm flats



## TOP OR SIDE MOUNT FIXTURES

- For CAT, BT, HSK, spindles
- Change retention knobs from bottom
- Bolts right to workbench

Part No.	Taper
17883	BT30, CAT 30
17884	BT40, CAT40
17885	BT50, CAT50
17893	HSK63A, 63B, 63D

## BENCHTOP MOUNT FIXTURE FOR CAT & BT

- Vertical and horizontal tightening fixtures



Part No.	Taper
17852	BT30
17854	BT40
17856	BT50
17870	CAT40
17872	CAT50

# SPINDLE WIPERS | ANALOG & TOUCH-LAMP PRESET GAUGES



## SPINDLE WIPERS

Part No.	Taper	Total Length	Taper Length
17706	30	170	60
17707	40	188	78
17708	50	240	120
38036	HSK63A	165	31
38032	HSK63F	165	31

## FEATURES

- For CAT, BT, ISO, HSK spindles
- Keep spindle and tapers clean

Real lambskin provides the best cleaning. Use with any type of machine with a taper of 7/24 CAT, BT or DIN 69871.



## ANALOG AXIAL PRESET GAUGE

Part No.	Description
17906-2	ZSI-50 preset gauge
17906-04	replacement dial

- Accuracy 0.0002"
- Easy to measure tool depth
- Height 2"

## INSTRUCTIONS

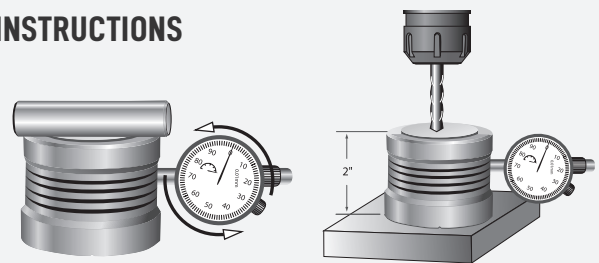

1. Use the gauge pin included to press down on the spring-loaded center piece as illustrated. Please be sure the gauge pin is placed on the shiny surface.
2. Turn the indicator to read "0", then remove the gauge pin.
3. Put the unit on the workpiece and carefully jog the tool down to make contact with the gauge face. When the gauge reads "0" the tool is 2" above the workpiece.



## FEATURES

- Accuracy .0002"
- 360° light radius
- Height 2"
- Magnetic base (use vertically or horizontally)

## TOUCH LAMP AXIAL PRESET GAUGE

Part No.	Description	A	B	C
07905-2	ZOP-50 Gauge	56mm	2"	13.5mm

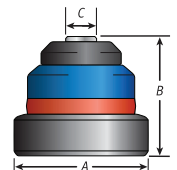

1. Check height of unit with a gauge block and dial indicator. Turn allen screw if adjustment is needed.
2. Do not use calipers for presetting unit, only use gauge block.
3. Move the cutting tool tip towards the sensor button until the lights turns on, reverse direction until light turns off.
4. When presetting diameter, rotate tool slowly for higher precision.

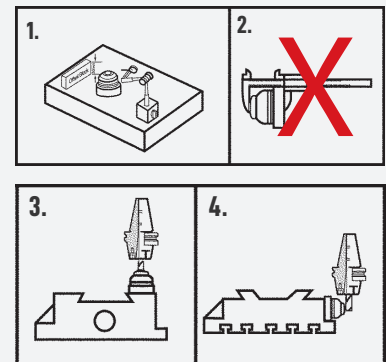



# STOP SCREWS & COOLANT PIPES

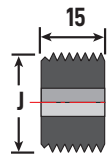
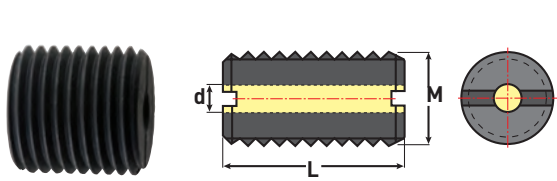

Figure 1

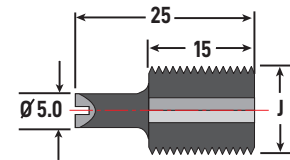

Figure 2

## COOLANT PRESET SCREWS

Part No.	T	L (mm)	d (mm)
16080C-20	M5 x 0.8P	20mm	2.5mm
16081C-20	M6 1.0P	20mm	2.5mm
16082C-20	M8 x 1.25P	20mm	4mm
16083C-20	M10 x 1.5P	20mm	4mm
16085C-20	M12 x 1.75P	20mm	4mm
16089C-20	M16 x 2.0P	20mm	5mm
16091C-20	M20 x 2.0P	20mm	5mm
16902C-15	M22 x 1.5P	15mm	5mm

## SOLID PRESET SCREWS

Part No.	T	L (mm)	Figure
16081	M6 x 1.0P	15mm	1
16083	M10 X 1.5P	15mm	1
16083-LH	M10 x 1.5P - left handed	15mm	1
16085	M12 X 1.75P	15mm	1
16087	M12 x 1.75P - extended	25mm	2
16088	M8 x 1.25P	16mm	1
16089	M16 x 2.0P	15mm	1
16089-LH	M16 x 2.0P - left handed	15mm	1
16091	M20 x 2.0P	15mm	1
16092	M20 x 2.0P	100mm	2
16092-15	N22 x 1.5P	15mm	1
16093	M24 x 2.0P	15mm	1
16094	M20 x 2.0P	50mm	1
16096	M16 x 2.0P	50mm	1

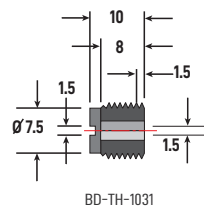

BD-TH-1031

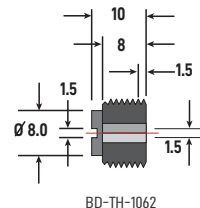

BD-TH-1062

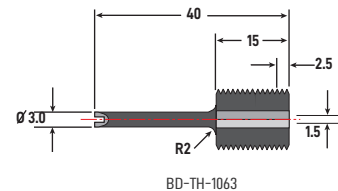

BD-TH-1063

## COOLANT PRESET SCREWS FOR STRAIGHT SHANK EXTENSIONS

Part No.	Description
BD-TH-1031	For M10 x 1.5 straight shank chuck with coolant – for small diameter tools
BD-TH-1062	For M12 x 1.75 straight shank chuck w/ coolant – for small diameter tools
BD-TH-1063	Long stop for M12 x 1.75 straight shank chuck w/coolant – for small diameter tools

## HSK & PSC COOLANT PIPES AND WRENCHES

Part No.	Taper	T	D (mm)	Wrench
92002	HSK40 A/E	M12 x 1P	8	91.11.026.002
92003	HSK50 A/E	M16 x 1P	10	91.11.026.003
92004	HSK63 A/E	M18 x 1P	12	91.11.026.004
92005	HSK100 A/E	M24 x 1.5P	16	91.11.026.005
143.003	PSC 6	M20 x 2.0P	8	91.11.026.002

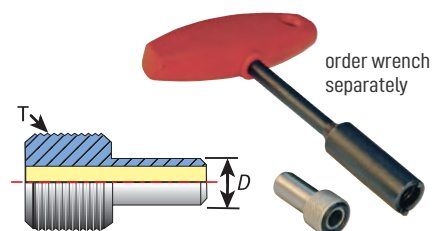

order wrench separately

# PRECISION TEST BARS & ATC CALIBRATION TOOLS

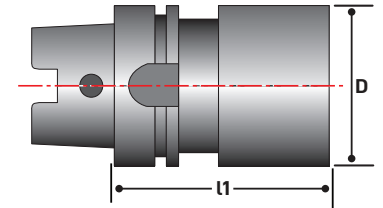
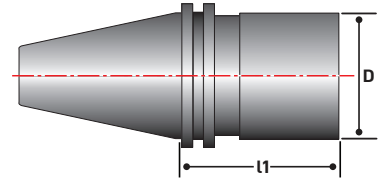

## FEATURES

- Made from high carbon chrome alloy steel
- Maximum 0.0001" T.I.R.
- Steep tapers ground to AT2 or better
- Includes detailed calibration certificate
- Packaged in watertight, crushproof, and dust-proof Pelican case

## TEST BARS

Part No.	Description	D	l1
P40-20TB12	40 Taper, 2" x 12" Precision Test Bar	2"	12"
P50-20TB12	50 Taper, 2" x 12" Precision Test Bar	2"	12"
H63A-40TB346	HSK63A, 40mm x 346mm Precision Test Bar	40mm	346mm
H100-40TB349	HSK100A, 40mm x 349mm Precision Test Bar	40mm	349mm



## CAT & BT ALIGNMENT TOOLS, HSK CALIBRATION TOOLS

Part No.	Description
21000-CAT40-3	CAT 40 Alignment Tool - 3 pcs
21000-CAT50-3	CAT 50 Alignment Tool - 3 pcs
16000-BT30-3	BT 30 Alignment Tool - 3 pcs.
16000-BT40-3	BT40 Alignment Tool - 3 pcs.
171.02.002.000	HSK 63F Calibration Tool - 4.975"

# HYDRAULIC INDICATOR ARMS

## ECE INDICATOR ARMS FEATURES

- "One Twist" 360° adjustable joints
- Hydraulic mechanism provides rigid set-up
- Powerful magnetic base

## ADVANTAGES OF HYDRAULIC ARMS

- Hydraulic arms are faster, stronger, and more precise than mechanical joints
- Hydraulic joints make fine adjustments easy because they don't lose position when loosened like mechanical arms



Indicator Arms are used to check concentricity on bench or machine. Dial Indicators not included.



ECE-300 series

ECE-330 series

ECE-340

Part No.	Description	Arm Length	Base Dim. Lmm x Wmm x H	Holding Power	Weight lb.
ECE-300ALL	Precision hydraulic arm, gold	23 1/2"	4 3/4"mm x 2"mm x 2 1/8"	352 lbs.	7.75
ECE-300AL	Precision hydraulic arm, gold	16 3/4"	3 1/8"mm x 2"mm x 2 1/8"	220 lbs.	5.5
ECE-300B	Precision hydraulic arm, gold	13 3/8"	2 3/8"mm x 2"mm x 2 1/8"	176 lbs.	4.5
ECE-330AL	Precision mechanical arm, red	16 3/4"	3 1/8"mm x 2"mm x 2 1/8"	220 lbs.	5.0
ECE-330B	Precision mechanical arm, red	13 3/8"	2 3/8" x 2" x 2 1/8"	176 lbs.	3.75
ECE-340	Standard mechanical arm, red	13 3/8"	2 3/8" x 2" x 2 1/8"	176 lbs.	3.5

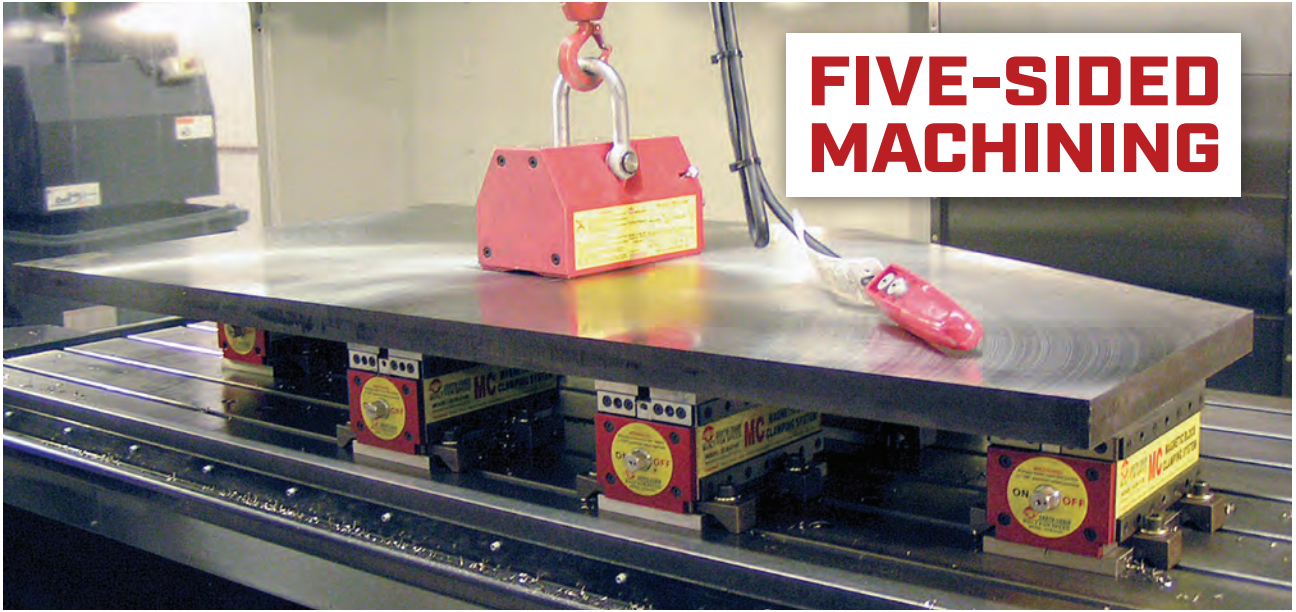

**MagVISE**  
magnetic workholding

MagVISE  
**E-C-B**  
WORKHOLDING  
VISES **EZ**  
**LIFT**

# ENGINEERED TURN-KEY MAGNETIC SOLUTIONS FOR ALL TYPES OF APPLICATIONS.

MAGNETIC CHUCKS | MAGNETIC VISES | MAGNETIC LIFTERS

Our MagVISE and EZ-LIFT brands offer the widest selection of magnetic workholding and lifting solutions. Our engineers work with you to provide custom TURN-KEY solutions that integrate easily into your production process in order to improve efficiency and maximize productivity.

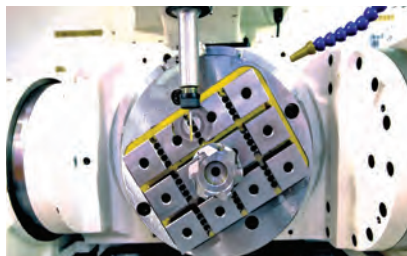

EEPM Chucks easily integrate into your CNC centers..



ECB magnetic vises are perfect for modular setups.



EZ-LIFT ELM magnetic lifters are powerful & compact.



# EPM MAGNETIC WORKHOLDING CHUCKS

## MagVISE magnetic workholding

### CHOOSE MAGNETIC WORKHOLDING

Compared to traditional fixturing methods, magnetic workholding frees up all five sides of your workpiece so you can machine the entire profile of the part in one set-up.

Magnetic workholding greatly reduces set up and part change-over time, giving your spindle more time to make chips.

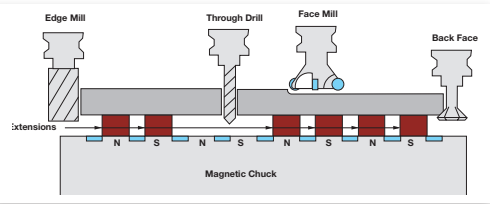

### RAIL PRODUCTION

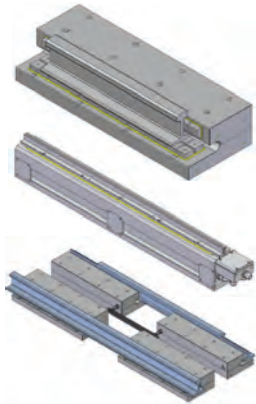

### COMPLEX WORKPIECES

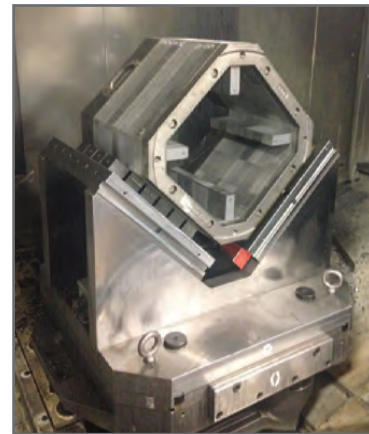

### AUTOMATED PALLET SYSTEMS

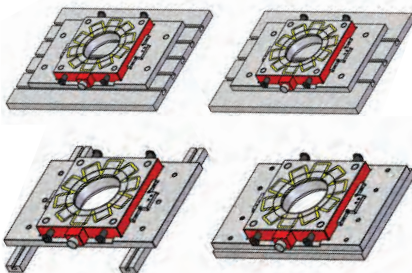

# EEPM MAGNETIC WORKHOLDING CHUCKS



Large plate EEPM customized to fit your system

EEPM chucks come with controller, a standard remote, and a touch-screen remote.

**MagVISE**  
magnetic workholding

## FEATURES:

- Up to 86,625 lbs holding power
- Turn chuck ON/OFF in only a few seconds – chuck will not lose magnetism if a power loss occurs
- Induction block and subplates provide additional setup options for small parts or warped stock

## ADVANTAGES:

- Machine freely on 5-sides & top so you can cut the full part profile in only one operation
- Reduce setup & change-over time by 50% or more!
- Very uniform holding = No workpiece deformation

Compared to traditional fixturing methods, magnetic workholding frees up all five sides of your workpiece so you can machine an entire profile in one set-up. Magnetic workholding greatly reduces set up and part change-over time, giving your spindle more time to make chips.

Thick or thin, large or small – just about any ferrous material can be held and machined magnetically. Larger parts are easier to hold because there is more material for the magnetic flux to penetrate.

For smaller parts, using work stops and nesting the part are options that work well. Magnetic workholding is used for just about all types of machining operations on horizontal or vertical CNC machines.

## HOW IT WORKS

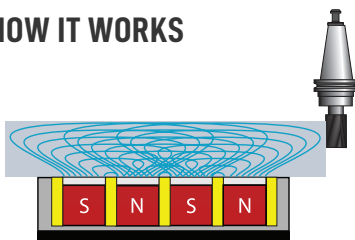

In the ON state, alnico and rare-earth magnets alternate poles, creating a powerful magnetic attraction. Holding power varies with type of material being held, surface finish, and part thickness.

Minimum recommended part size is 5" x 5" x 3/8" thick, so a minimum of 4 magnetic poles are covered by the part. Workstops, pins or part nesting techniques ensure the ability to hold small, thin parts without movement.

## APPLICATION EXAMPLES

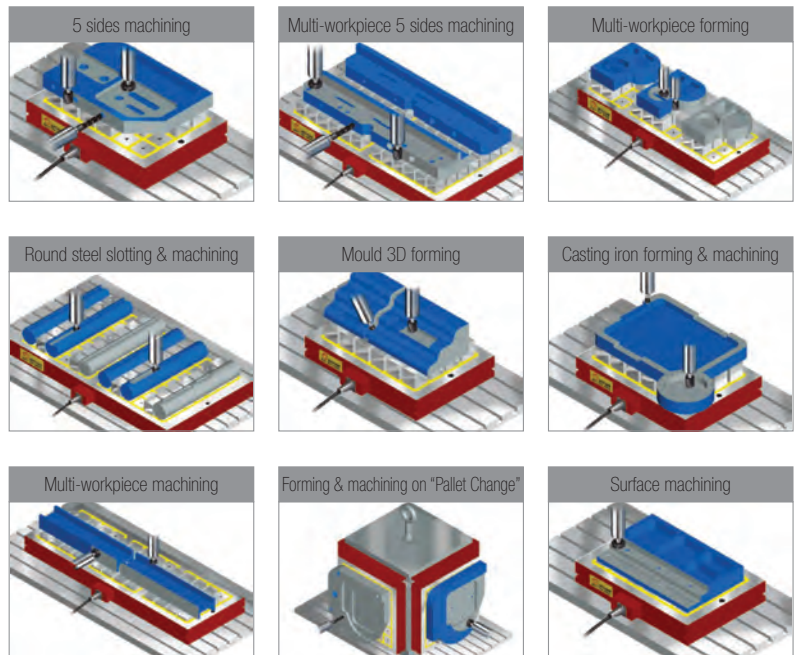



# EEPM MAGNETIC WORKHOLDING CHUCKS

$$S = 1.2" \quad S1 = 1" \quad G = 0.4 \quad M = 1.2"$$

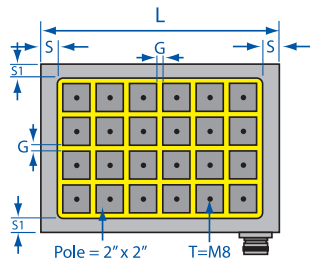

Fig. 1

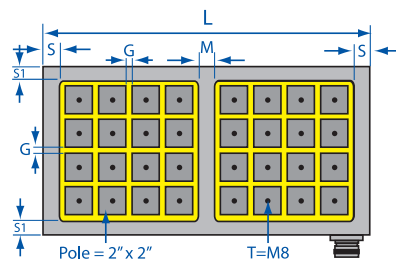

Fig. 2

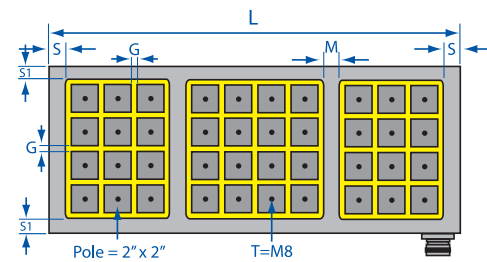

Fig. 3

Model	Fig	L x W x H	Poles	Holding Power	Weight	Subplate	Power	Controller
EEPM-2540B	1	16.9" x 9.4" x 2.36"	18	12,375 lbs.	110 lbs.	EEPM-2540ISP	220v- 480v, 1 phase	EEPM-C1
EEPM-2560B	2	23.2" x 9.4" x 2.36"	24	16,500 lbs.	152 lbs.	EEPM-2560ISP	220v- 480v, 1 phase	EEPM-C1
EEPM-2580B	3	31.9" x 9.4" x 2.36"	33	22,687 lbs.	202 lbs.	EEPM-2580ISP	220v- 480v, 1 phase	EEPM-C1
EEPM-2590B	3	34.3" x 9.4" x 2.36"	36	24,750 lbs.	216 lbs.	EEPM-2590ISP	220v- 480v, 1 phase	EEPM-C2
EEPM-25100B	3	39.0" x 9.4" x 2.36"	42	28,875 lbs.	244 lbs.	EEPM-25100ISP	220v- 480v, 1 phase	EEPM-C2
EEPM-3030B	1	12.2" x 11.8" x 2.36"	16	11,000 lbs.	97 lbs.	EEPM-3030ISP	220v- 480v, 1 phase	EEPM-C1
EEPM-3040B	1	16.9" x 11.8" x 2.36"	24	16,500 lbs.	134 lbs.	EEPM-3040ISP	220v- 480v, 1 phase	EEPM-C1
EEPM-3060B	2	23.2" x 11.8" x 2.36"	32	22,000 lbs.	180 lbs.	EEPM-3060ISP	220v- 480v, 1 phase	EEPM-C1
EEPM-3080B	3	31.9" x 11.8" x 2.36"	44	30,250 lbs.	255 lbs.	EEPM-3080ISP	220v- 480v, 1 phase	EEPM-C2
EEPM-3090B	3	34.3" x 11.8" x 2.36"	48	33,000 lbs.	271 lbs.	EEPM-3090ISP	220v- 480v, 1 phase	EEPM-C2
EEPM-30100B	3	39.0" x 11.8" x 2.36"	56	38,500 lbs.	304 lbs.	EEPM-30100ISP	220v- 480v, 1 phase	EEPM-C2
EEPM-4040B	1	16.9" x 16.5" x 2.36"	36	24,750 lbs.	185 lbs.	EEPM-4040ISP	220v- 480v, 1 phase	EEPM-C1
EEPM-4050B	1	18.9" x 16.9" x 2.36"	42	28,875 lbs.	209 lbs.	EEPM-4050ISP	220v- 480v, 1 phase	EEPM-C2
EEPM-4060B	2	23.2" x 16.5" x 2.36"	48	33,000 lbs.	255 lbs.	EEPM-4060ISP	220v- 480v, 1 phase	EEPM-C2
EEPM-4080B	3	31.9" x 16.5" x 2.36"	66	45,375 lbs.	350 lbs.	EEPM-4080ISP	220v- 480v, 1 phase	EEPM-C2
EEPM-4090B	3	34.3" x 16.5" x 2.36"	72	49,500 lbs.	372 lbs.	EEPM-4090ISP	220v- 480v, 1 phase	EEPM-C2
EEPM-40100B	3	39.0" x 16.5" x 2.36"	84	57,750 lbs.	425 lbs.	EEPM-40100ISP	220v- 480v, 1 phase	EEPM-C4
EEPM-5060B	2	23.2" x 18.9" x 2.36"	56	38,500 lbs.	284 lbs.	EEPM-5060ISP	220v- 480v, 1 phase	EEPM-C2
EEPM-5080B	3	31.9" x 18.9" x 2.36"	77	52,937 lbs.	407 lbs.	EEPM-5080ISP	220v- 480v, 1 phase	EEPM-C4
EEPM-5090B	3	34.3" x 18.9" x 2.36"	84	57,750 lbs.	431 lbs.	EEPM-5090ISP	220v- 480v, 1 phase	EEPM-C4
EEPM-50100B	3	39.0" x 18.9" x 2.36"	98	67,375 lbs.	482 lbs.	EEPM-50100ISP	220v- 480v, 1 phase	EEPM-C4
EEPM-6060B	2	23.2" x 23.6" x 2.36"	72	49,500 lbs.	363 lbs.	EEPM-6060ISP	220v- 480v, 1 phase	EEPM-C2
EEPM-6080B	3	31.9" x 23.6" x 2.36"	99	68,062 lbs.	473 lbs.	EEPM-6080ISP	220v- 480v, 1 phase	EEPM-C4
EEPM-6090B	3	34.3" x 23.6" x 2.36"	108	74,250 lbs.	528 lbs.	EEPM-6090ISP	220v- 480v, 1 phase	EEPM-C4
EEPM-60100B	3	39.0" x 23.6" x 2.36"	126	86,625 lbs.	603 lbs.	EEPM-60100ISP	220v- 480v, 1 phase	EEPM-C4
EEPM-8080B	3	31.9" x 29.7" x 2.36"	121	83,187 lbs.	596 lbs.	EEPM-8080ISP	220v- 480v, 1 phase	EEPM-C4

EEPM magnets ship with controller.

## EEPM INDUCTION BLOCKS

Use induction blocks to elevate the workpiece above the surface of the magnet and permit machining 5 sides and thru-hole drilling. Individual induction blocks provide maximum flexibility for creating custom setups for holding difficult workpieces and warped stock.

We recommend using induction blocks at all times to preserve the precision ground finish and prevent damage to the face of the magnetic chuck.

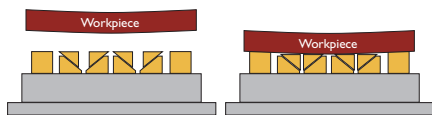
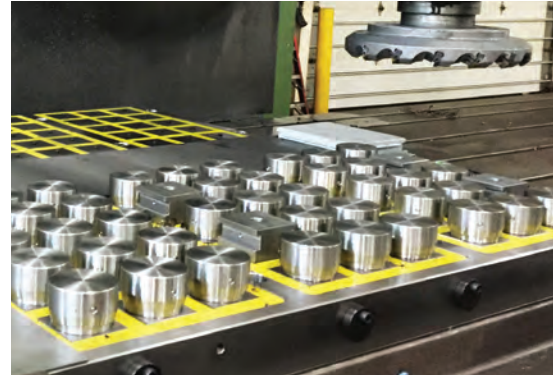

Use EEPM-SPF induction blocks on the corners and EEPM-SP spring loaded blocks everywhere else so the induction blocks adjust to match the warped stock.



Square spring block

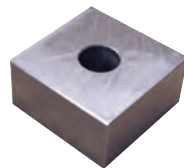

Square solid block



Round Solid & Spring-loaded Blocks

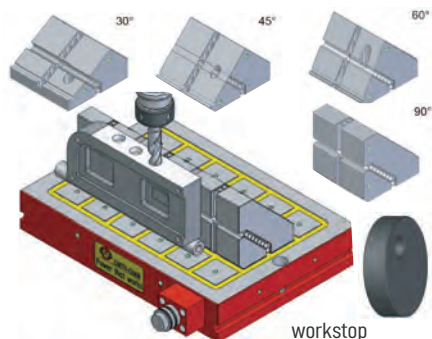

## SQUARE SOLID INDUCTION BLOCKS

Part No.	Description	L	W	H
EEPM-SPF	Square Solid Induction Block for 50mm pole	50mm	50mm	32.5mm
EEPM-SPF35	Square Solid Induction Block for 35mm pole	35mm	35mm	23mm
EEPM-SPF70	Square Solid Induction Block for 70mm pole	70mm	70mm	32.5mm

## SQUARE SPRING-LOADED INDUCTION BLOCKS

Part No.	Description	L	W	H
EEPM-SP	Square Spring-Loaded Ind. Block for 50mm pole	48mm	48mm	30/35mm
EEPM-SP35	Square Spring-Loaded Ind. Block for 35mm pole	35mm	33mm	21/25mm
EEPM-SP70	Square Spring-Loaded Ind. Block for 70mm pole	68mm	65mm	30/35mm

## ROUND SOLID INDUCTION BLOCKS

Part No.	Description	Dia.	H
EEPM-RF50	Round Solid Induction Block for 50mm pole	52mm	32.5mm
EEPM-RF35	Round Solid Induction Block for 35mm pole	37mm	23mm
EEPM-RF70	Round Solid Induction Block for 70mm pole	72mm	32.5mm

## ROUND SPRING-LOADED INDUCTION BLOCKS

Part No.	Description	Dia.	H
EEPM-SPR50	Round Spring-Loaded Induction Block for 50mm pole	52mm	30/35mm
EEPM-SPR70	Round Spring-Loaded Induction Block for 70mm pole	72mm	39/45mm

## ANGLED INDUCTION BLOCKS & WORKSTOP

Part No.	Desc.
EEPM-IBT30	30° angle, 4-pole induction block
EEPM-IBT45	45° angle, 4-pole induction block
EEPM-IBT60	60° angle, 4-pole induction block
EEPM-IBT90	90° angle, 4-pole induction block
EEPM-PS40	round workstop (replacement)

# EEPM CHUCKS FOR LARGE WORKPIECES



## 70MM POLE FEATURES:

- Up to 98,767 lbs. holding power
- Reduce setup time by 50%
- Machine freely on 5-sides

S = 1.2"  
S1 = 1"  
G = 0.78"

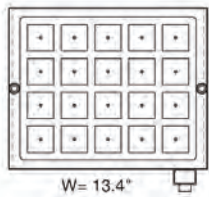

Figure 1

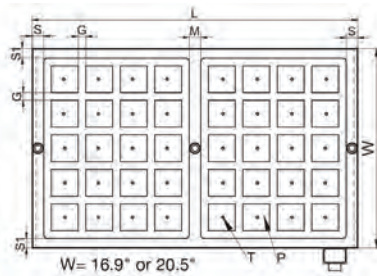

Figure 2

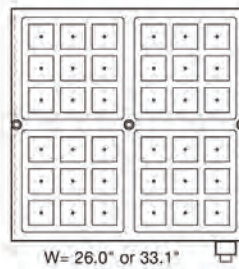
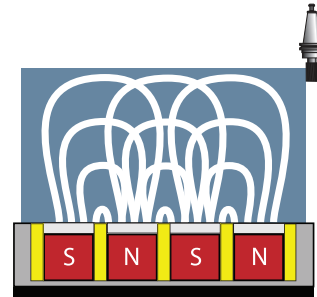

Figure 3



70mm pole chucks provide the most powerful flux lines with the furthest extension into the workpiece. Most effective for large workpieces.

Model	Fig	L x W x H	Poles	Holding Pwr.	Weight	Subplate	Power	Controller
EEPM-3060D-480	1	26.4" x 13.4" x 2.8"	18	27,778 lbs.	278 lbs.	EEPM-3060DISP	480V, 1 phase	EEPM-C1
EEPM-4050D-480	2	20.9" x 16.9" x 2.8"	20	30,864 lbs.	278 lbs.	EEPM-4050DISP	480V, 1 phase	EEPM-C1
EEPM-4060D-480	2	26.4" x 16.9" x 2.8"	24	37,037 lbs.	350 lbs.	EEPM-4060DISP	480V, 1 phase	EEPM-C1
EEPM-4080D-480	2	33.5" x 16.9" x 2.8"	32	49,383 lbs.	445 lbs.	EEPM-4080DISP	480V, 1 phase	EEPM-C2
EEPM-5060D-480	2	26.4" x 20.5" x 2.8"	30	46,297 lbs.	425 lbs.	EEPM-5060DISP	480V, 1 phase	EEPM-C2
EEPM-5080D-480	2	33.5" x 20.5" x 2.8"	40	61,729 lbs.	538 lbs.	EEPM-5080DISP	480V, 1 phase	EEPM-C2
EEPM-6060D-480	3	26.4" x 26.0" x 2.8"	36	55,556 lbs.	540 lbs.	EEPM-6060DISP	480V, 1 phase	EEPM-C2
EEPM-6080D-480	3	33.5" x 26.0" x 2.8"	48	74,075 lbs.	683 lbs.	EEPM-6080DISP	480V, 1 phase	EEPM-C2
EEPM-8080D-480	3	33.5" x 33.1" x 2.8"	64	98,767 lbs.	870 lbs.	EEPM-8080DISP	480V, 1 phase	EEPM-C4



Our 70MM pole chucks provide the increased holding power needed for large workpieces, thick plates, blocks and molds.

Great choice for drilling, milling, and boring operations on vertical or horizontal mills. They easily integrate with pallet changing and tombstone systems.

# EEPM CHUCKS FOR THIN WORKPIECES

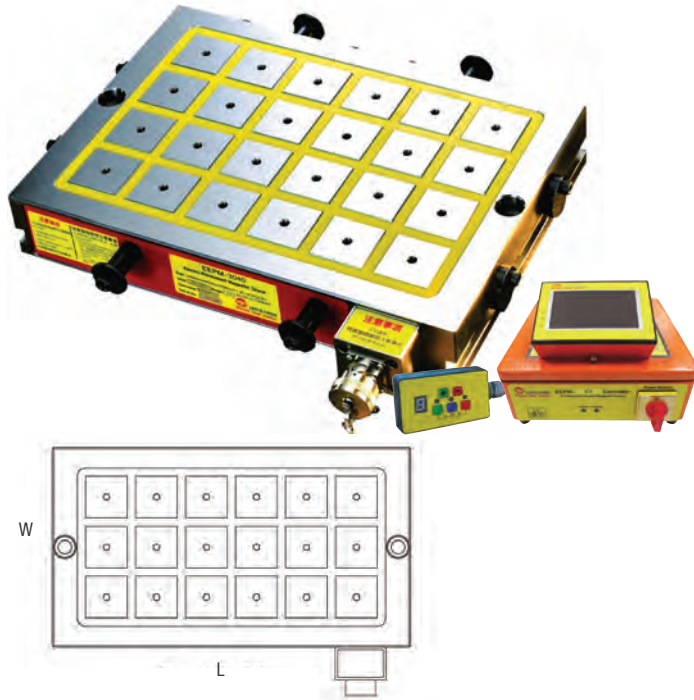

## 35MM POLE FEATURES:

- Up to 34,524 lbs. holding power
- Designed for thinner material
- Reduce setup time by 50%

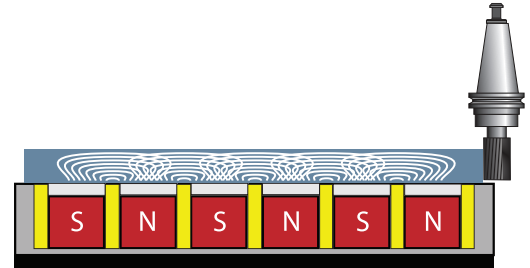

35mm pole chucks feature flux lines concentrated closer to the surface, providing more magnetic coverage of thin material.

Model	L x W x H	Poles	Holding Power	Weight	Subplate	Power	Controller
EEPM-1530A	12.6" x 7.3" x 1.9"	18	5,754 lbs.	51 lbs.	EEPM-1530ISPA	220-480V, 1 phase	EEPM-C1
EEPM-2540A	17.3" x 8.9" x 1.9"	32	10,229 lbs.	86 lbs.	EEPM-2540ISPA	220-480V, 1 phase	EEPM-C1
EEPM-2560A	24.0" x 8.9" x 1.9"	48	15,344 lbs.	119 lbs.	EEPM-2560ISPA	220-480V, 1 phase	EEPM-C2
EEPM-3030A	12.6" x 12.2" x 1.9"	36	11,508 lbs.	86 lbs.	EEPM-3030ISPA	220-480V, 1 phase	EEPM-C1
EEPM-3040A	17.3" x 12.2" x 1.9"	48	15,344 lbs.	117 lbs.	EEPM-3040ISPA	220-480V, 1 phase	EEPM-C2
EEPM-3060A	24.0" x 12.2" x 1.9"	72	23,016 lbs.	163 lbs.	EEPM-3060ISPA	220-480V, 1 phase	EEPM-C2
EEPM-4040A	17.3" x 17.1" x 1.9"	72	23,016 lbs.	165 lbs.	EEPM-4040ISPA	220-480V, 1 phase	EEPM-C2
EEPM-4050A	20.7" x 17.1" x 1.9"	90	28,770 lbs.	198 lbs.	EEPM-4050ISPA	220-480V, 1 phase	EEPM-C4
EEPM-4060A	24.0" x 17.1" x 1.9"	108	34,524 lbs.	229 lbs.	EEPM-4060ISPA	220-480V, 1 phase	EEPM-C4

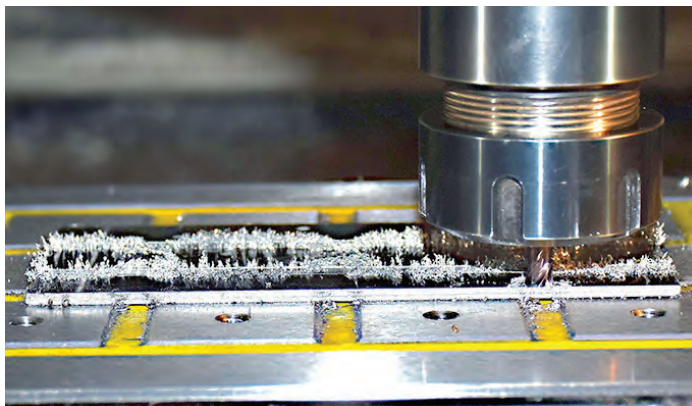

Our 35MM pole chucks are built specifically for the machining of thin workpieces. They are a great choice for machining operations on either vertical or horizontal mills. They easily integrate with pallet changing and tombstone systems.



# EPM-C MODULAR WORKHOLDING CHUCKS



For workholding of ferrous materials only.

## FEATURES:

- Modular connectivity capable of conforming multiple chucks to your unique part and set up
- Operate as many as 16 chucks with 1 controller
- 8,250 lbs. holding power (each chuck)\*

## ADVANTAGES:

- Easy to setup and adjust for large or irregular parts
- Reduced investment vs. larger, single magnetic chuck setup
- Easy to move and setup from machine to machine

EPM-C chucks provide almost unlimited flexibility to hold workpieces of varying sizes. Use clamps or bolts to position EPM-C magnets anywhere on your machine bed or pallet to fit your workpiece.

\*Holding power varies with material type, surface finish, and part thickness.

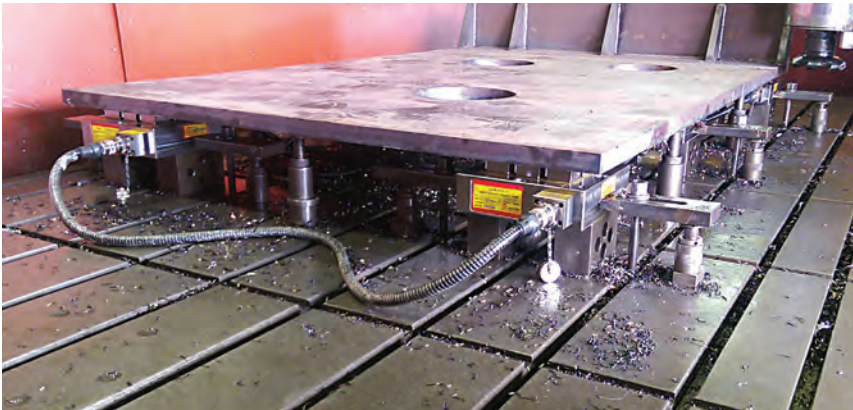

Use for fast setups on plate stock

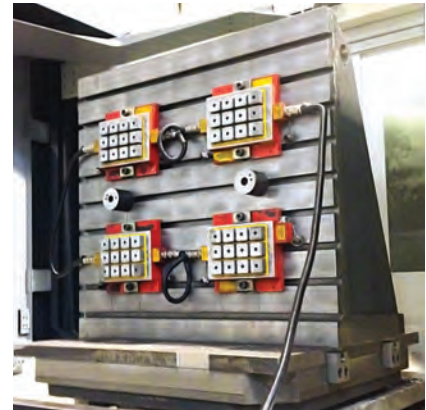

Configure multiple chucks to a variety of setups



Large tooth sprocket being machined



Modular setups adjust easily to part

# EEPM-C MODULAR WORKHOLDING CHUCKS

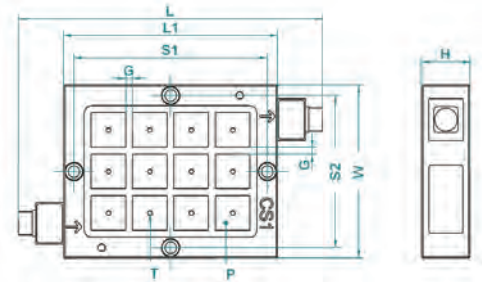

Part No.	W	L	L1	S1	S2	H	T	Pole	No. of Poles	Holding Power	Weight
EEPM-2030C	190mm	440mm	310mm	280mm	160mm	70mm	M8	50mm x 50mm	8	5,500 lbs.	73.7 lbs.
EEPM-2525C	250mm	380mm	250mm	220mm	220mm	70mm	M8	50mm x 50mm	9	6,160 lbs.	77 lbs.
EEPM-2530C	250mm	440mm	310mm	280mm	220mm	70mm	M8	50mm x 50mm	12	8,250 lbs.	96.8lbs.

\*Holding power varies with type of material being held, surface finish, and part thickness.



Controller requires a dedicated 480V single phase, 30A power supply. C4 control features 4 channels to control up to 16 chucks. Control each channel independently.

Part No.	Description	L x W x H	Channels	Qty. Chucks
EEPM-C4C	Controller for 1-16 EEPM-C magnetic chucks	10.6" x 7" x 5"	4	1-16



Connection Cables	Length
EEPM-CC05	19.6"
EEPM-CC10	39.37"
EEPM-CC15	59"



Position the chucks on the machine bed



Connect the control cables to chucks and control

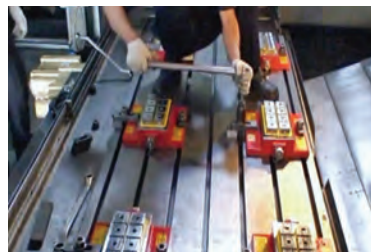

Lock them in position using bolts provided



Position workpiece and start machining



# EETM-V CHUCKS FOR HORIZONTAL MACHINING

## FEATURES:

- Up to 68,640 lbs. holding power\*
- Choose from 2 or 4 sided chucks
- 36, 42, or 100 pole chucks, 16.9" to 29.9"

## ADVANTAGES:

- Reduce setup & change-over time by 50% or more!
- Machine freely on all 5-sides to reduce operations
- Very uniform holding = No workpiece deformation



\*4 sizes available  
For workholding of ferrous materials only.

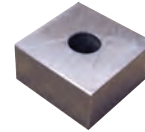
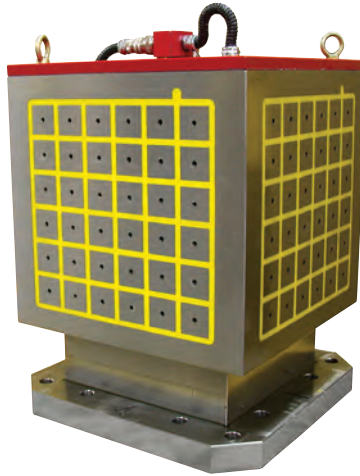

Induction Blocks  
see page 247.

## INDUCTION BLOCKS & SUB-PLATES

We recommend using induction blocks or subplates at all times to preserve the precision ground finish and prevent damage to the face of the magnetic chuck.

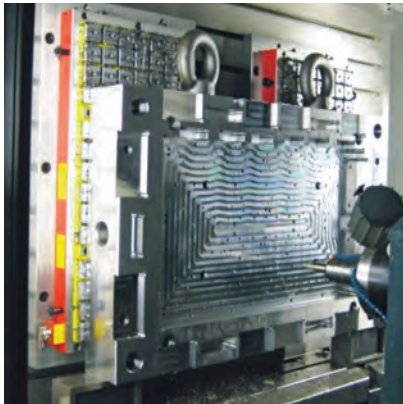

Mold making application



2-sided EETM on palletized system

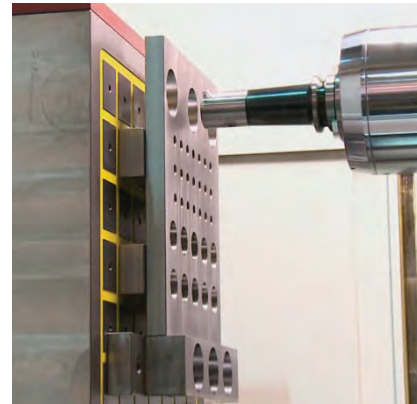

Hole-making applications are no problem



Complex part shapes - 5 sides machining

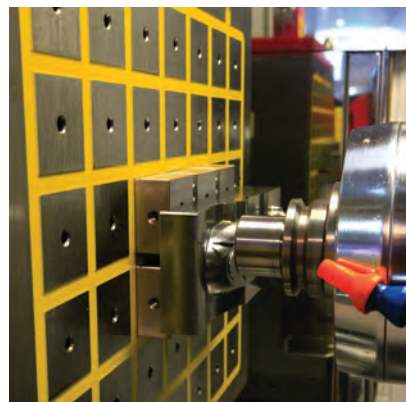

Finish pass using small tools

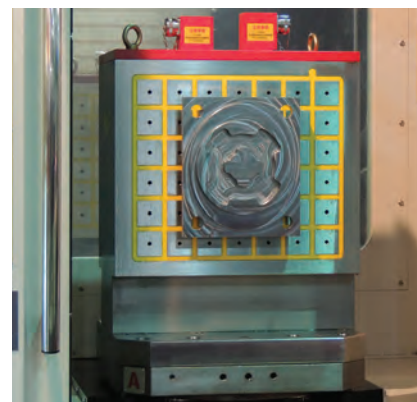

Palletized horizontal workholding chuck

# EETM-V CHUCKS FOR HORIZONTAL MACHINING

## ORDERING EETM-V CHUCKS

- Select the number of faces and chucks required
- Controller is included with chuck
- Order induction blocks from page 247

## WE MANUFACTURE CUSTOM TOMBSTONES

- Built to your specifications.  
Call us to discuss your needs.
- (800) 597-3921 or local (317) 803-8000



EETM chucks includes controller and remote.  
Control requires a dedicated 480V single phase, 30A power supply

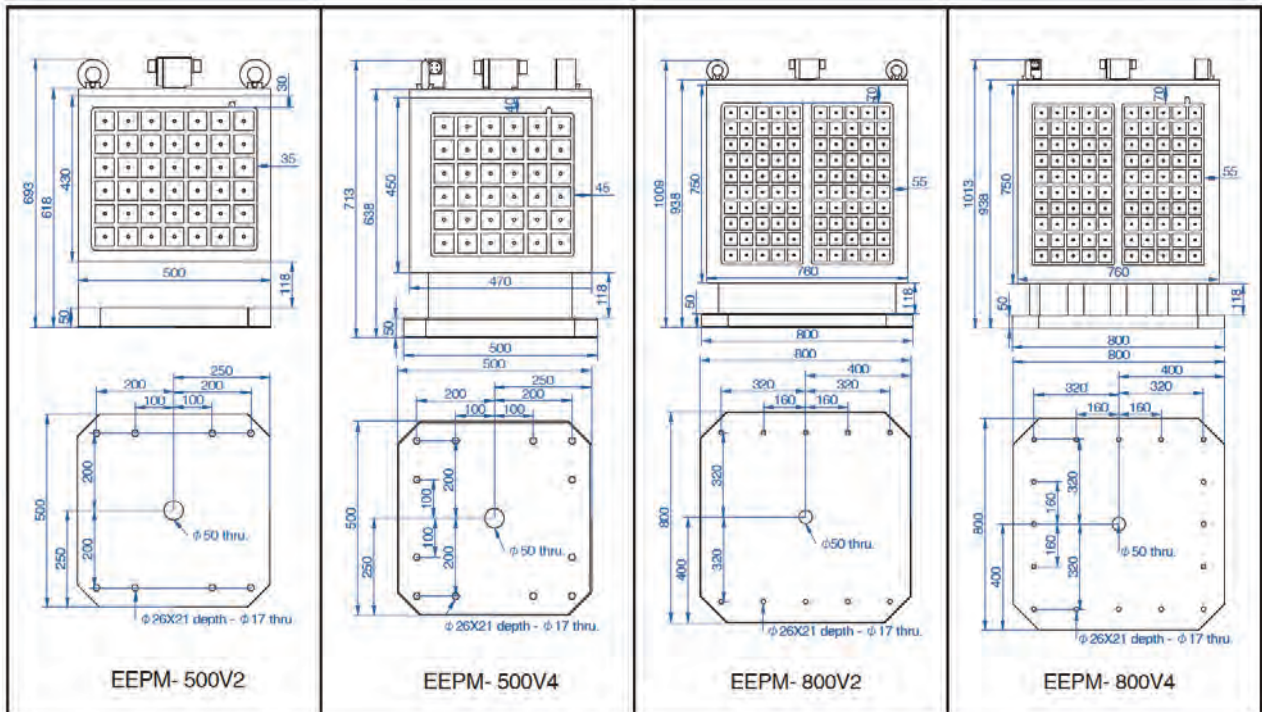
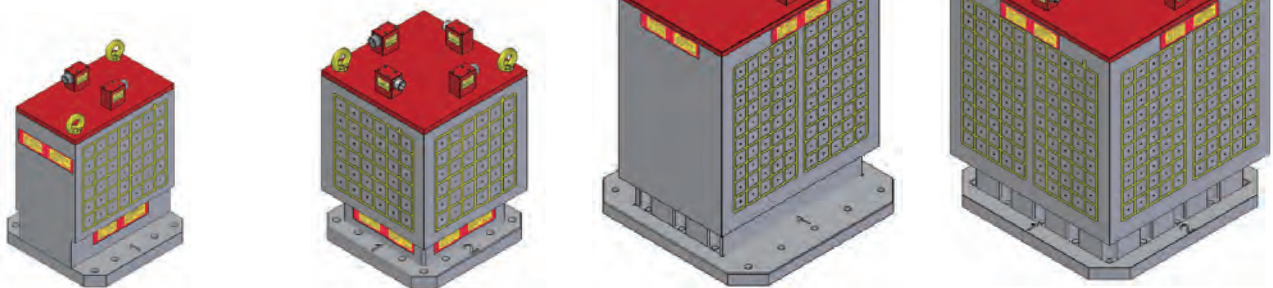

Model	Face (L x W)	No. Faces	No. Poles	Holding Power / Face	Weight	Controller
EETM-500V2	16.9" x 19.68"	2	42	28,820 lbs.	1,058 lbs.	EETM-C2
EETM-500V4	17.7" x 18.5"	4	36	24,640 lbs.	1,124 lbs.	EETM-C2
EETM-800V2	29.5" x 29.9"	2	100	68,640 lbs.	1,675 lbs.	EETM-C2
EETM-800V4	29.5" x 29.9"	4	100	68,640 lbs.	1,786 lbs.	EETM-C2



# EEPM-CIR FOR VERTICAL TURNING & 5-AXIS

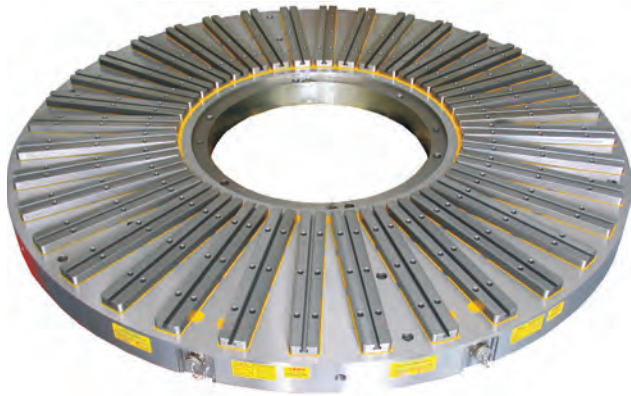

## ADVANTAGES:

- Reduce setup & change-over time by 50% or more!
- Machine freely on all 4-sides & top so you can cut the full part profile in only 1 operation
- Very uniform holding = No workpiece deformation

EEPM-CIR chucks are a powerful and fast workholding solution optimized for horizontal or vertical turning centers and 5-axis machining. Using magnetic workholding you can clamp/un-clamp the part in only seconds. Reduce setup down-time to increase machine up-time. Controller is included with chuck.

For workholding of ferrous materials only.  
9 sizes to choose from. Custom sizes available. includes controller and remote

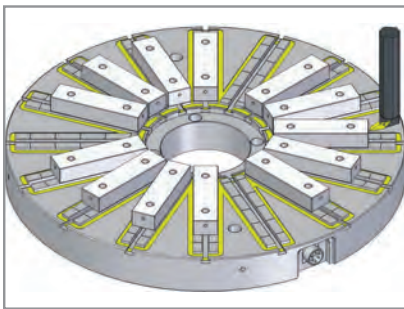

Machine induction blocks for easy part positioning

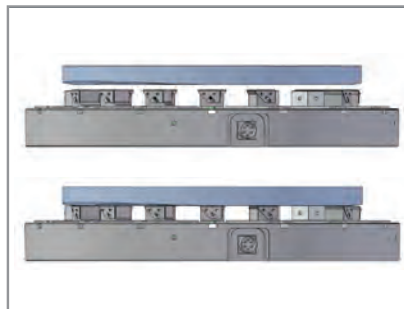

Use with EEPM-SP blocks to hold warped stock

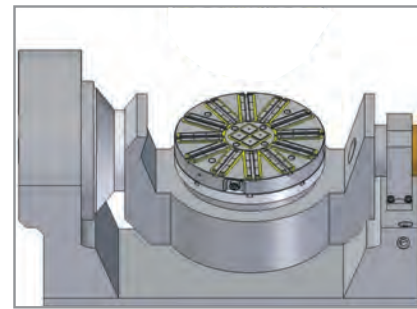

Speed up setups for 5-axis tables

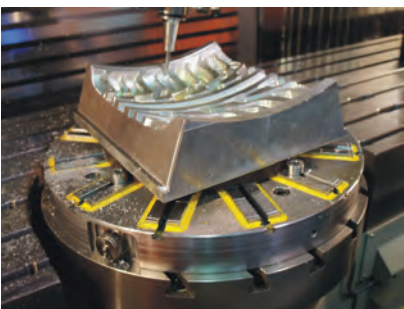

3, 4, and 5-axis applications



Even workholding - no part distortion



Off-axis rotation on horizontal mill

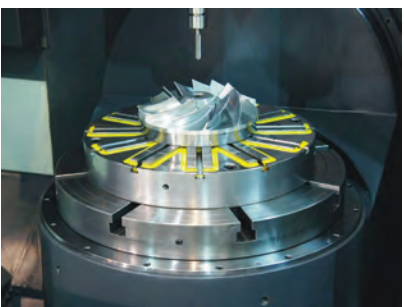

Holds very small or very large parts

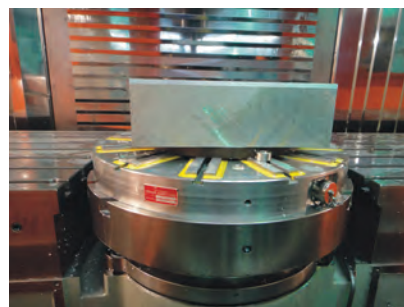

Custom chucks available to suit your machine

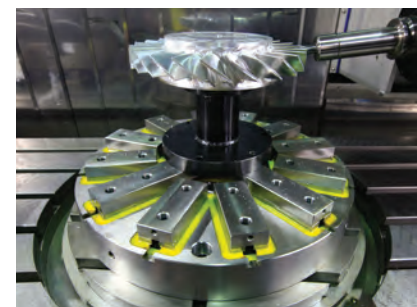

Hold complex parts without complicated setups!

# EEPM-CIR FOR VERTICAL TURNING & 5-AXIS



circular chuck setup for gear cutting

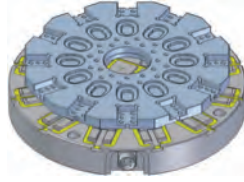

pocket milling and face milling



5-axis turbine blade machining

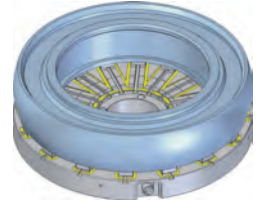

round part turning O.D. and I.D.

Model	Dim. (O.D. x I.D. x H)	No. Poles	Holding Power	Weight	Control
EEPM-CIR500	19.7" x 0" x 2.75"	12 + 4	12,345 lbs.	229 lbs.	C1
EEPM-CIR600	23.6" x 0" x 2.75"	12 + 4	17,636 lbs.	326 lbs.	C2
EEPM-CIR800	31.5" x 9.84" x 3.34"	16	28,219 lbs.	665 lbs.	C2
EEPM-CIR1000	39.4" x 9.84" x 3.34"	16	42,328 lbs.	1,038 lbs.	C4
EEPM-CIR1250	49.6" x 19.68" x 4.33"	24	52,910 lbs.	1,825 lbs.	C4
EEPM-CIR1500	59.0" x 19.68" x 4.72"	24	74,075 lbs.	2,921 lbs.	C8
EEPM-CIR1600	64.2" x 19.68" x 4.72"	24	84,657 lbs.	3,322 lbs.	C8
EEPM-CIR1800	71.6" x 31.49" x 4.72"	36	111,112 lbs.	5,048 lbs.	C8
EEPM-CIR2000	80.7" x 39.37" x 5.11"	36	111,112 lbs.	5,489 lbs.	C8

## INDUCTION BLOCKS & T-SLOT SLIDING BLOCKS FOR EEPM CIR CHUCKS

Use induction blocks to preserve the precision ground finish and prevent damage to the face of the chuck. Induction blocks elevate the workpiece above the surface of the magnet and permit machining 5 sides and thru-hole drilling. Use T-Slot Sliding Blocks as adjustable workstops for part alignment.

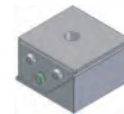

EEPM-SP



EEPM-SPF

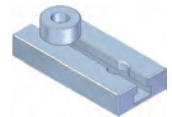

Sliding T-Slot

	Part No.	Description	L	W	H
EEPM-CIRIB120	EEPM-SP	spring loaded (2 piece set, 8mm screw)	1.89"	1.89"	1.41"
EEPM-CIRIB170	EEPM-SPF	solid, machinable (8mm screw)	1.97"	1.97"	1.23"
EEPM-CIRIB245	EEPM-20T	sliding T-slot for use with EEPM-SPF	4.72"	1.97"	.78"
EEPM-CIRIB335	EEPM-30T	sliding T-slot for use with EEPM-SP blocks	4.72"	1.97"	1.18"
EEPM-CIRIB220	EEPM-CIRIB120	induction block for CIR500 chuck	4.72"	1.97"	.78"
EEPM-CIRIB270	EEPM-CIRIB170	induction block for CIR600 chuck	6.69"	1.97"	.78"
	EEPM-CIRIB245	induction block for CIR800 chuck	9.64"	1.97"	.78"
	EEPM-CIRIB335	induction block for CIR1000 chuck	13.18"	1.97"	.78"
	EEPM-CIRIB220	induction block for CIR500 chuck	8.66"	1.97"	.78"
	EEPM-CIRIB270	induction block for CIR600 chuck	10.62"	1.97"	.78"



# EEPM-CIRS FOR MACHINING & GRINDING

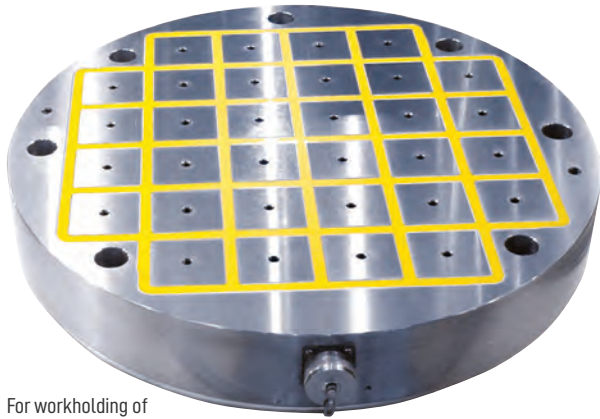

For workholding of ferrous materials only.

EEPM chucks includes controller and remote. Control requires a dedicated 480V single phase, 30A power supply

## ADVANTAGES:

- Versatile round chucks to fit a variety of applications
- Reduce setup & change-over time by 50% or more!
- Machine freely on 5-sides so you can cut the full part profile in only one operation

There are 9 stock sizes of EEPM-CIRS chucks to choose from (see table below). We also can build custom chucks for your machine.

We recommend using induction blocks to preserve the precision ground finish and prevent damage to the face of the chuck. You can easily modify induction blocks to your part requirements. Use EEPM-SP induction blocks for holding warped stock.

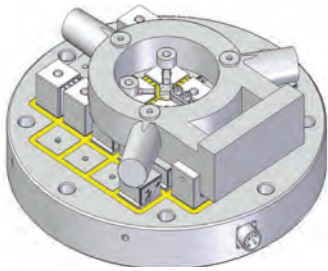

Use induction blocks as workstops to hold hard parts

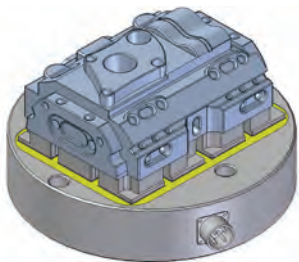

Machine full 5 sides using induction blocks

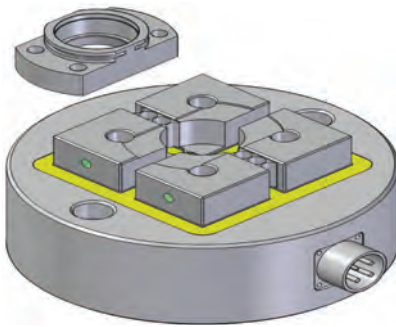

Machine nests to hold smaller parts

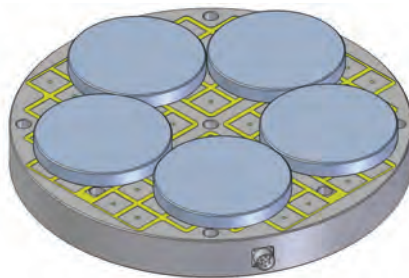

Gang parts together on larger chucks for efficiency

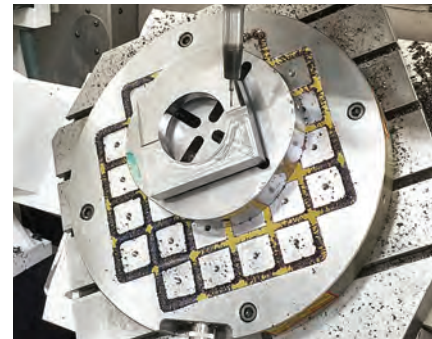
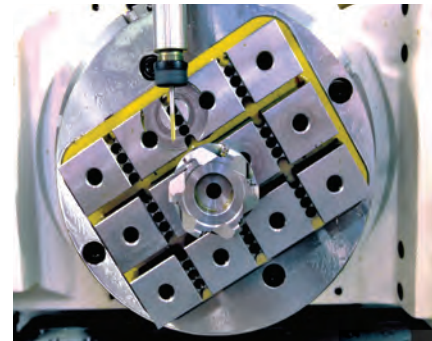

Model	Dim. (O.D. x H)	No. Poles	Holding Power	Weight	Controller
EEPM-CIRS200	7.99" x 2.75"	4	2,204 lbs.	35 lbs.	C1
EEPM-CIRS300	12.0" x 2.75"	12	6,612 lbs.	77 lbs.	C1
EEPM-CIRS500	19.68" x 2.75"	32	17,632 lbs.	214 lbs.	C1
EEPM-CIRS600	24.4" x 2.75"	52	28,652 lbs.	330 lbs.	C2
EEPM-CIRS700	27.55" x 2.75"	76	41,876 lbs.	421 lbs.	C4
EEPM-CIRS800	32.28" x 2.75"	96	52,896 lbs.	578 lbs.	C4
EEPM-CIRS900	35.82" x 3.14"	120	66,120 lbs.	798 lbs.	C4
EEPM-CIRS1000	40.15" x 3.14"	164	90,364 lbs.	1,022 lbs.	C8
EEPM-CIRS1100	45.54" x 3.14"	204	112,404 lbs.	1,203 lbs.	C8

# EEPM-IT INDEX TABLE



includes C4 control and remote

## FEATURES:

- Pneumatic table makes rotation easy
- Indexed in 5 degree increments
- Full 360° rotation either left or right

## ADVANTAGES:

- Add indexing capability to your horizontal mill
- Machine 5-sides freely and reduce setup time 50%
- Very uniform holding = No workpiece deformation



Use EZ-Lift lifting magnet to quickly load your workpiece

Pull the black knob out to un-clamp table and rotate part. Push knob in to clamp. Index table requires 90 psi shop air for rotation.

We recommend using induction blocks or subplates at all times to preserve the precision ground finish and prevent damage to the face of the magnetic chuck.

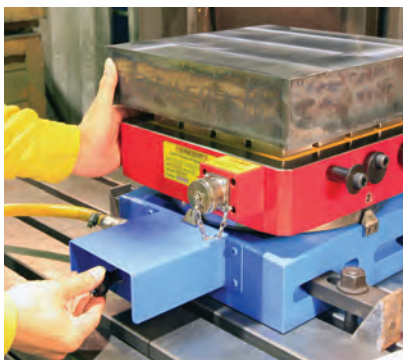

Pull knob to rotate part up to 360 degrees  
Use induction blocks to machine full 5 sides freely



Add indexing capability to your mill



For workholding of ferrous materials only

Model	Face (L x W x H)	Max. Load	No. Poles	Holding Power	Squareness	Repeatability	Weight
EEPM-300IT	11.81" x 11.81" x 7.59"	1,100 lbs.	16	11,023 lbs.	.0004"	.0004"	229 lbs.
EEPM-470IT	18.5" x 18.5" x 7.36"	2,200 lbs.	49	33,730 lbs.	.0005"	.0004"	490 lbs.
EEPM-600IT	23.6" x 23.6" x 8.89"	4,400 lbs.	72	49,604 lbs.	.0007"	.0005"	996.5 lbs.
EEPM-800IT	31.5" x 31.5" x 11.88"	6,600 lbs.	144	99,208 lbs.	.0007"	.0005"	2,162.5 lbs.



# EEPM-PIM PLASTIC INJECTION MOLD CLAMPING MAGNETS

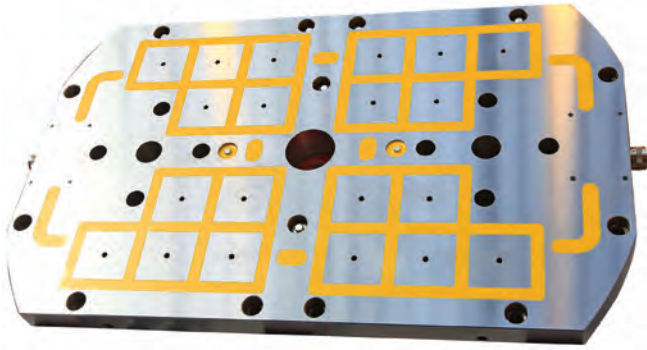

## FEATURES

- Reduce setup & change-over time
- Increase machine capacity
- Greatly improve overall productivity
- Easily integrates into your current PIM system

MagVISE PIM magnetic chucks are the perfect solution for quick mold and die change for plastic injection, metal stamping, die casting and rubber molding. The overall effectiveness of the magnetic mold clamping surpasses traditional clamping methods, increasing productivity and quality with faster and safer mold changes.

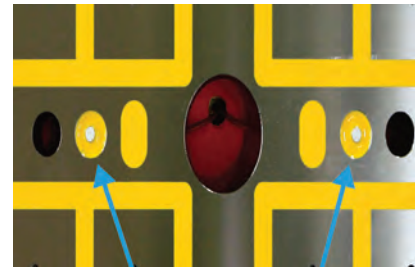

Proximity sensors ensure correct positioning

<b>Safety</b> ⚡	Control requires simultaneous turn-key/button press activation.
<b>Reliability</b> ⚡	No moving or wearable parts, maintenance-free.
<b>Uniform clamping force</b> ⚡	Magnetic force is applied to entire surface area of mold.
<b>Quality</b> ⚡	Absolute uniformity increases rigidity for better quality parts.
<b>Flexibility</b> ⚡	We design custom chucks for any application.
<b>Increased mold life</b> ⚡	No deformation, extends the longevity of molds.
<b>Green technology</b> ⚡	No electrical power needed once energized.



Controls require operator to use both hands



Load and install PIM magnet with bolts

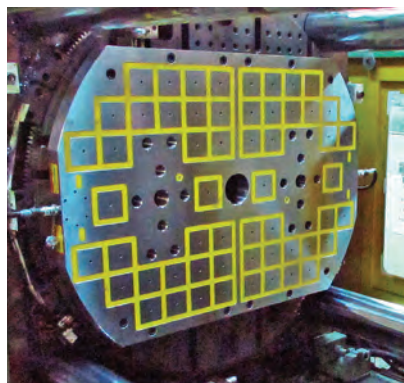

PIM & controls integrate with your machine

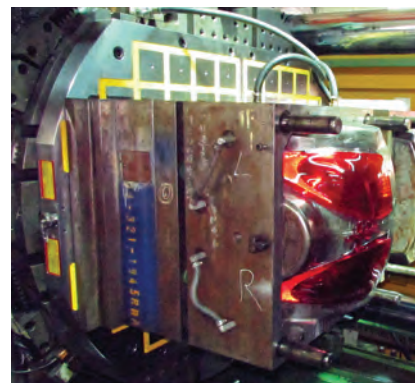

Mold is held perfectly, & change-over is fast

Model	Face (L x W x H)	Max Temp (F)	Holding Power	Pole Size (mm)	Power Supply
EEPM-1200PIM	59" x 59" x 2.75"	248 °	185,188 lbs.	92 x 92	35A, 480V single phase
EEPM-950PIM	57" x 41.3" x 2.75"	248 °	148,150 lbs.	92 x 92	30A, 480V single phase
EEPM-400PIM	41.3" x 25.6" x 2.75"	248 °	52,910 lbs.	92 x 92	40A, 480V single phase

## MagVISE E-C-B WORKHOLDING VISES



4 sizes available.  
For workholding of ferrous materials only.  
Each ECB vise includes everything required  
to setup and begin workholding.



### FEATURES

- Powerful rare-earth magnets deliver up to 4,620 lbs. holding power (per vise)
- Gang multiple vises together and increase holding power as needed
- Quickly & easily adjust size of setup and number of chucks as needed

### BENEFITS

- Reduce setup & change-over time by 50% or more!
- Freely machine on all 5-sides to reduce operations
- No workpiece deformation

### POWERFUL, COMPACT WORKHOLDING FOR ALL TYPES OF FERROUS MATERIALS

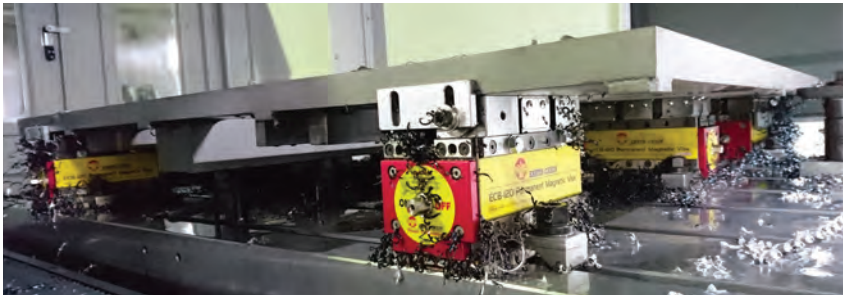

ECB Magnetic Vises provide fast, efficient workholding for all types of CNC machining applications. They are easy to install and move from machine to machine, or make changes to existing setups.

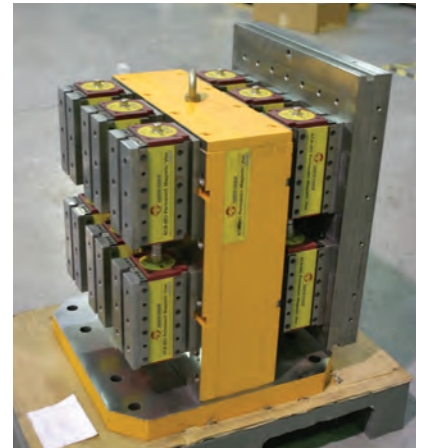

ECB vises easily integrate with pallet changing and tombstone systems used in production cells

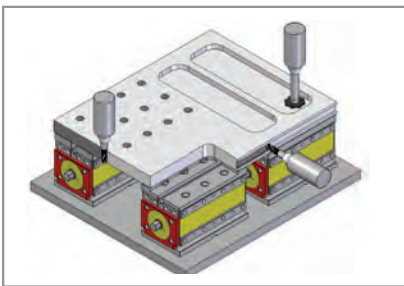

Machine freely on 5-sides using induction blocks

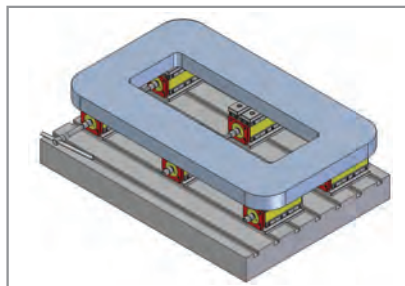

Switch-connect to turn ON/OFF multiple vises

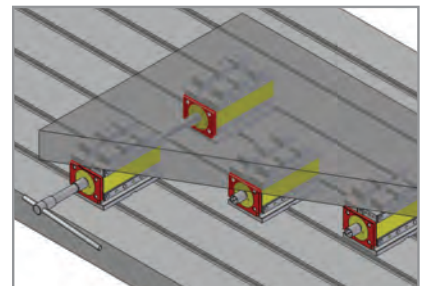

Position ECB vises just where you need them

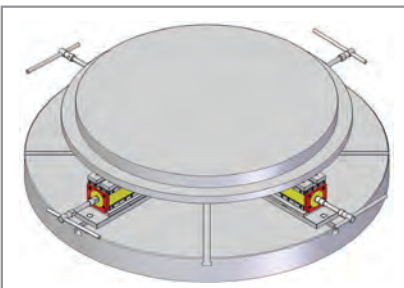

Vertical turning setups are faster with ECB vises

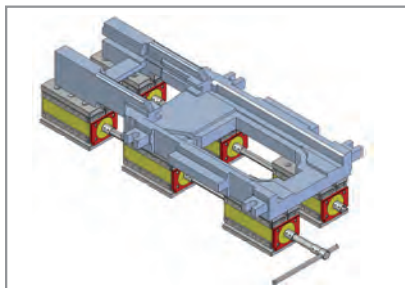

Cut complex part shapes O.D. and I.D.

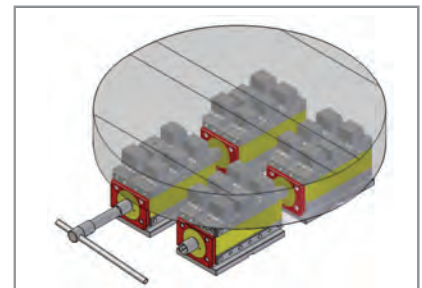

Hold large and small parts of all shapes



# ECB VISES AND ACCESSORIES

## MagVISE E-C-B WORKHOLDING VISES

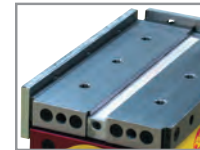
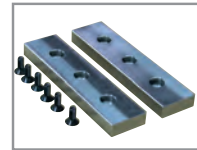

Induction soft blocks and work stops are included.



Switch-connect vises to turn them ON/OFF in unison.

Our ECB series magnetic vise blocks are our most modular workholding solutions for all types of applications.

**Each ECB vise includes:** two induction soft blocks, wrench, extension and socket, switch-connect socket assembly, 2 stop plates and 4 toe clamps.

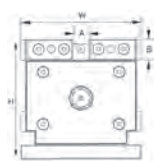

end view

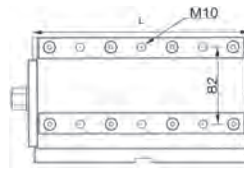

side view

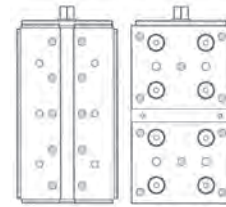

top and bottom view

### ECB MAGNETIC VISES

Part No.	L x W x H	A	B	Min. Stock Thickness	Holding Power	Weight
ECB-050	5" x 3" x 3"	.47"	.47"	0.4"	1,100 lbs.	15 lbs.
ECB-075	6.8" x 3" x 3"	.47"	.47"	0.4"	1,650 lbs.	19 lbs.
ECB-120	7.3" x 4.2" x 4.2"	.62"	.59"	0.6"	2,640 lbs.	40 lbs.
ECB-210	9.2" x 5.2" x 5.3"	.65"	.84"	0.8"	4,620 lbs.	80 lbs.

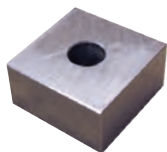

EEPM-SPF  
solid type



EEPM-SP  
spring type

Use EEPM-SP spring-loaded induction blocks and EEPM-SPF blocks together to hold warped stock. Use induction blocks at all times to prevent damage to the face of the magnetic vise. You can easily modify induction blocks to adapt your setup to part requirements.

After installing your ECB vise we recommend milling the surface of your induction blocks before loading your workpiece to ensure that the surface height is uniform & parallel to the spindle.

Please note: Spring loaded blocks are NOT machineable. Solid blocks ARE able to be drilled and machined as required.



### REPLACEMENT INDUCTION SOFT BLOCKS FOR ECB VICES

Part No.	Description
ECB-05024	Induction Soft Block Set for ECB-050 (2 pcs)
ECB-07524	Induction Soft Block Set for ECB-075 (2 pcs)
ECB-12024	Induction Soft Block Set for ECB-120 (2 pcs)
ECB-21024	Induction Soft Block Set for ECB-210 (2 pcs)

### ECB INDUCTION BLOCKS

Part No.	Description
EEPM-SPF	Square Solid Induction Block for ECB-120
EEPM-SP	Square Spring-Loaded Induction Block for ECB-120
ECB-SPF	Square Solid Induction Block for ECB-210
ECB-SP	Square Spring-Loaded Induction Block for ECB-210

# EDMT SURFACE GRINDING CHUCKS



For induction blocks see page 247.

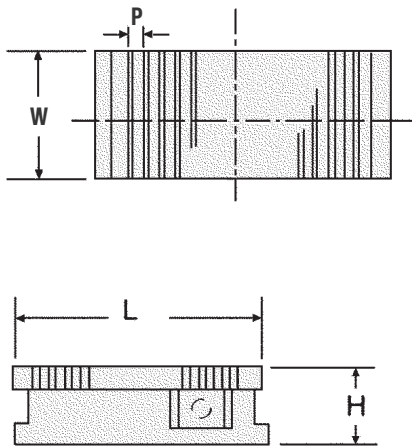

## EDMT (ALL-PURPOSE VARIABLE POLE DESIGN)

Alternating thick/thin magnetic poles provides best holding power for both thick and thin workpieces.

- **EDM-READY:** fully submersible, brass welded faceplate which can be machined if needed, and protects the magnetic system from penetration of coolant.
- **Needs no electricity.** Provides a constant source of workholding power.
- **Low-profile design increases Z-axis stroke**
- **Housing and bottom plate are free of magnetism** —will not magnetize machine bed or bearings.

## VARIABLE POLE

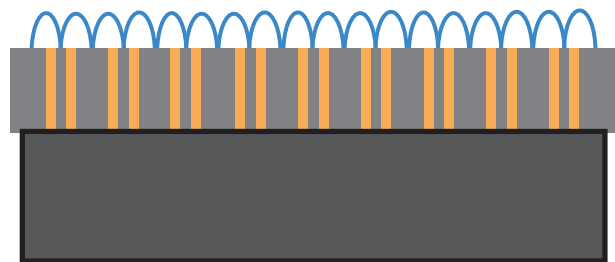

\*New variable pole design creates magnetic fields that hold both thin and thick workpieces equally well.

Model	Pole Pitch (P) (mm)	L x W x H	Weight
EDMT-1018	11.2 (1.6+2+1.6+6)	7" x 4" x 2.5"	16 lbs.
EDMT-1325	11.2 (1.6+2+1.6+6)	10" x 5" x 2.5"	23 lbs.
EDMT-1530	11.2 (1.6+2+1.6+6)	12" x 6" x 2.5"	33 lbs.
EDMT-1535	11.2 (1.6+2+1.6+6)	14" x 6" x 2.5"	38 lbs.
EDMT-1545	11.2 (1.6+2+1.6+6)	18" x 6" x 2.5"	44 lbs.
EDMT-2040	11.2 (1.6+2+1.6+6)	16" x 8" x 2.5"	57 lbs.
EDMT-2045	11.2 (1.6+2+1.6+6)	18" x 8" x 2.5"	66 lbs.
EDMT-2050	11.2 (1.6+2+1.6+6)	20" x 8" x 2.5"	79 lbs.
EDMT-2550	4 + 12	20" x 10" x 2.5"	130 lbs.
EDMT-3060	3 + 15	24" x 12" x 2.5"	198 lbs.

# EDTW FINE POLE SURFACE GRINDING CHUCKS

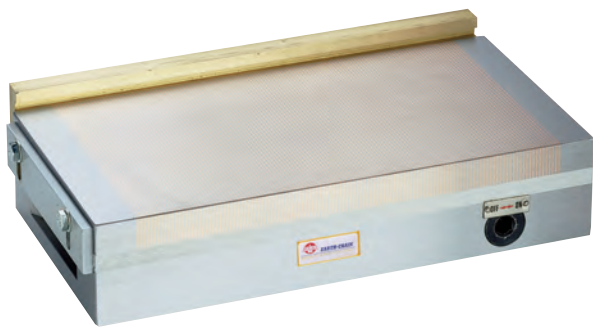

For induction blocks see page 247.

## EDTW (MICROPITCH FINE POLE DESIGN)

Fine pole design provides best holding power for surface grinding of small or thin workpieces.

- Brass welded faceplate can be machined if needed, and protects the magnetic system from penetration of coolant.
- Needs no electricity. Provides a constant source of workholding power.
- Low-profile design increases Z-axis stroke
- Housing and bottom plate are free of magnetism —will not magnetize machine bed or bearings

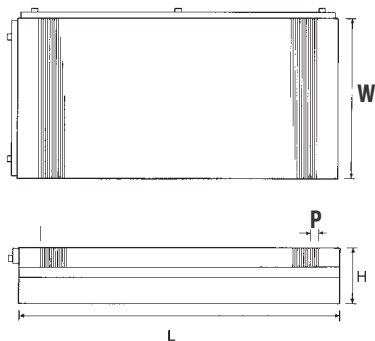

EDTW chucks have up to 15 tons of holding force. (150 lbs./inch<sup>2</sup>)

## FINE POLE

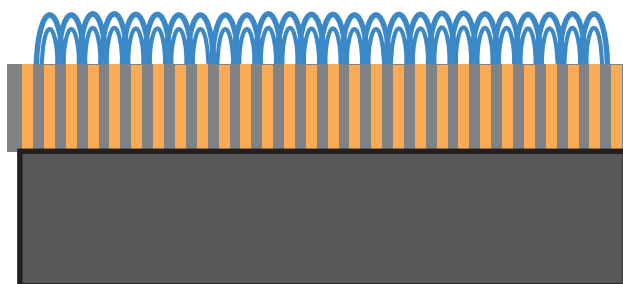

Fine pole magnets creates strongest magnetic field close to surface for holding thin workpieces.

Model	Pole Pitch (P) (mm)	L x W x H	Weight
EDTW-1018	2 (1+1)	7" x 4" x 2"	15 lbs.
EDTW-1325	2 (1+1)	10" x 5" x 2.25"	29 lbs.
EDTW-1515	2 (1+1)	6" x 6" x 2.25"	20 lbs.
EDTW-1530	2 (1+1)	12" x 6" x 2.5"	49 lbs.
EDTW-1535	2 (1+1)	14" x 6" x 2.5"	53 lbs.
EDTW-1545	2 (1+1)	18" x 6" x 2.5"	68 lbs.
EDTW-2040	2 (1+1)	16" x 8" x 2.5"	82 lbs.
EDTW-2045	2 (1+1)	18" x 8" x 2.5"	90 lbs.
EDTW-2050	2 (1+1)	20" x 8" x 2.5"	99 lbs.
EDTW-2550	2 (1+1)	20" x 10" x 2.5"	132 lbs.



# EET SURFACE GRINDING CHUCKS



For induction blocks see page 247.

## EET (WIDE SPACED POLE DESIGN)

Wider spacing magnetic poles for general surface grinding of both thick and thin workpieces.

- Brass welded faceplate can be machined if needed, and protects the magnetic system from penetration of coolant.
- More than 1,000 OHMs resistance
- Low-profile design increases Z-axis stroke
- Housing and bottom plate are free of magnetism —will not magnetize machine bed or bearings

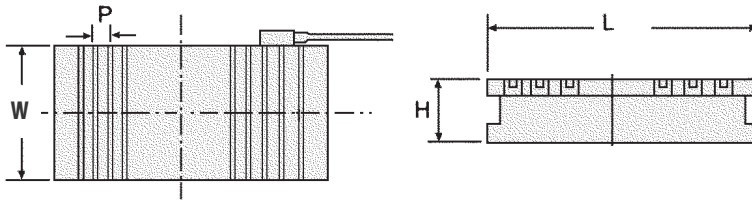

Model	Pole Pitch (P)	L x W x H	Volts	Amps	Weight
EET-1530	15 (3+12)	12" x 6" x 3"	DC90V	0.18	44 lbs.
EET-1535	15 (3+12)	14" x 6" x 3"	DC90V	0.19	53 lbs.
EET-1545	15 (3+12)	18" x 6" x 3"	DC90V	0.19	66 lbs.
EET-2040	15 (3+12)	16" x 8" x 3"	DC90V	0.28	84 lbs.
EET-2045	15 (3+12)	18" x 8" x 3"	DC90V	0.28	90 lbs.
EET-2050	15 (3+12)	20" x 8" x 3"	DC90V	0.36	99 lbs.
EET-2550	15 (3+12)	20" x 10" x 3"	DC90V	0.46	143 lbs.
EET-3060	15 (3+12)	24" x 12" x 3"	DC90V	0.86	179 lbs.
EET-3070	15 (3+12)	28" x 12" x 3"	DC90V	0.81	205 lbs.
EET-3090	15 (3+12)	35" x 12" x 3"	DC90V	1.05	276 lbs.
EET-4060	19 (3+16)	24" x 16" x 3.5"	DC90V	0.95	287 lbs.
EET-4070	19 (3+16)	28" x 16" x 3.5"	DC90V	1.21	333 lbs.
EET-4080	19 (3+16)	32" x 16" x 3.5"	DC90V	1.31	384 lbs.
EET-40100	19 (3+16)	40" x 16" x 3.5"	DC90V	1.33	487 lbs.
EET-50100	19 (3+16)	40" x 20" x 3.5"	DC90V	1.46	595 lbs.
EET-50150	19 (3+16)	60" x 20" x 3.5"	DC90V	3.37	893 lbs.
EET-60100	19 (3+16)	40" x 24" x 3.5"	DC90V	2.80	728 lbs.
EET-60150	19 (3+16)	60" x 24" x 3.5"	DC90V	2.85	1091 lbs.
EET-80100	19 (3+16)	40" x 32" x 3.5"	DC90V	3.80	970 lbs.

# EET-W FINE POLE SURFACE GRINDING CHUCKS



For induction blocks see page 247.

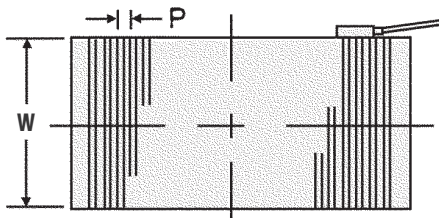
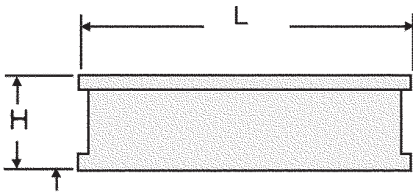

## EET-W (FINE POLE DESIGN)

Fine pole design optimized for maximum holding power for surface grinding of thin workpieces.

- Brass welded faceplate which can be machined if needed, protects the magnetic system from penetration of coolant
- More than 1,000 OHMs resistance
- Low-profile design increases Z-axis stroke
- Housing and bottom plate are free of magnetism —will not magnetize machine bed or bearings

Fine Pole

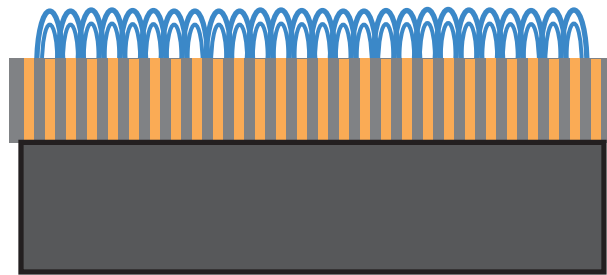

Fine pole magnets create strongest magnetic field close to surface for holding thin workpieces.

Model	Pole Pitch (P) (mm)	L x W x H	Voltage	Amps	Weight
EET-1530W	4(1+3)	12" x 6" x 4.5"	DC90V	0.73	73 lbs.
EET-1535W	4(1+3)	14" x 6" x 4.5"	DC90V	0.61	88 lbs.
EET-1545W	4(1+3)	18" x 6" x 4.5"	DC90V	0.98	110 lbs.
EET-2040W	4(1+3)	16" x 8" x 4.5"	DC90V	1.10	139 lbs.
EET-2045W	4(1+3)	18" x 8" x 4.5"	DC90V	1.20	157 lbs.
EET-2050W	4(1+3)	20" x 8" x 4.5"	DC90V	1.40	176 lbs.
EET-2550W	4(1+3)	20" x 10" x 4.5"	DC90V	1.00	247 lbs.
EET-3060W	4(1+3)	24" x 12" x 4.5"	DC90V	1.50	331 lbs.

# INDUCTION BLOCKS FOR SURFACE GRINDING

## EHT INDUCTION BLOCKS:

- Extends magnetic force to hold bar, round, or irregular shapes
- EDM-READY: fully submersible, brass sealed
- For fine-pole and standard pole applications

Choose from lengthwise (L) or width-wise (W) pole direction

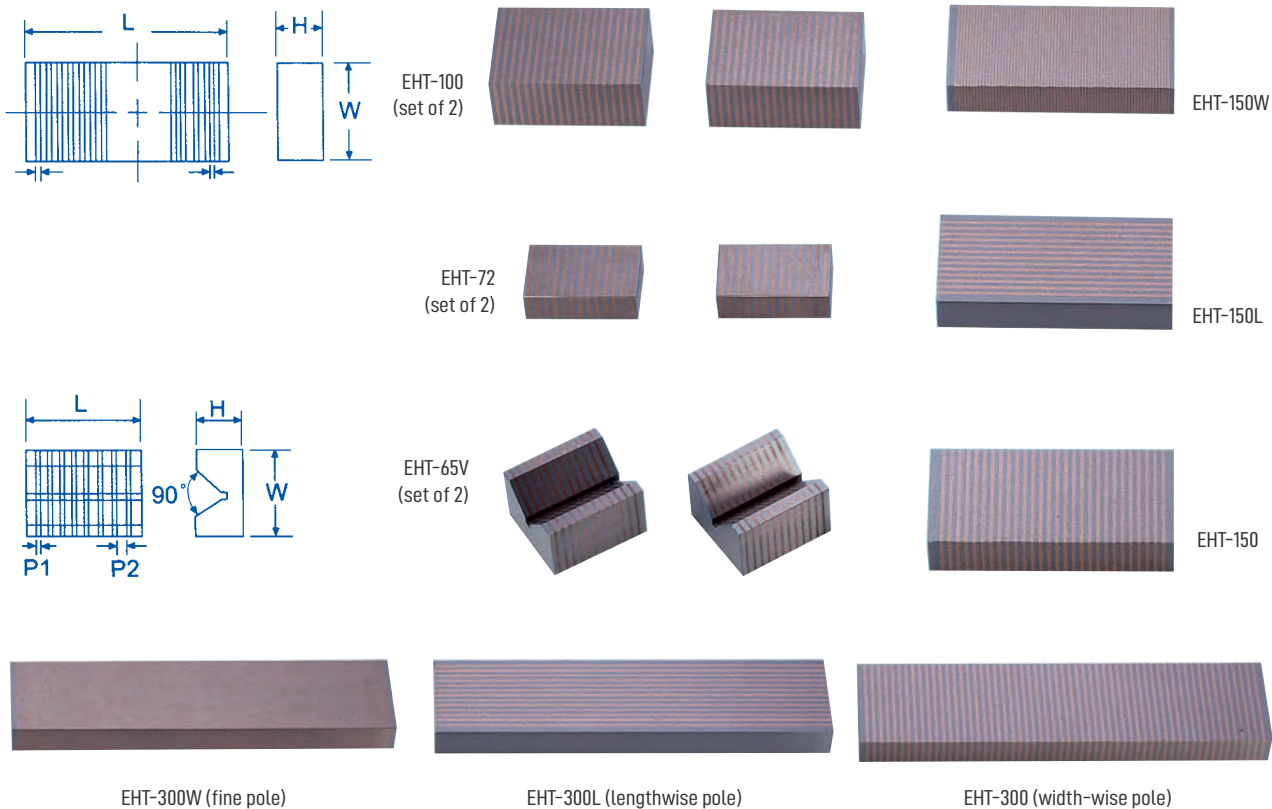

Model	Qty.	L x W x H	Pole Pitch P1 (mm)	Pole Pitch P2 (mm)	Weight
EHT-65V	2	2.5" x 2.5" x 1.5"	2	3	4 lbs. (x2)
EHT-72	2	3" x 2" x 1"	2	3	7 lbs. (x2)
EHT-100	2	4" x 3" x 1.5"	2	3	10 lbs. (x2)
EHT-150	1	6" x 3" x 1"	2	3	5 lbs.
EHT-300	1	12" x 3" x 1"	2	3	10 lbs.
EHT-150L	1	6" x 3" x 1"	2	3	5 lbs.
EHT-300L	1	12" x 3" x 1"	2	3	10 lbs.
EHT-150W	1	6" x 3" x 1"	1+1	1+1	5 lbs.
EHT-300W	1	12" x 3" x 1"	1+1	1+1	10 lbs.

# MAGNETIC V-BLOCKS

## ECE MAGNETIC BLOCKS

- Dozens of uses around the shop
- Fast setups of bar stock or round steel
- Powerful magnetic base, ON-OFF switch

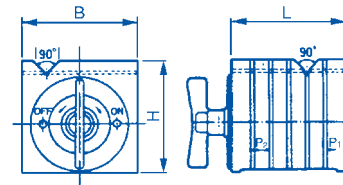

ECE-100 / ECE-150

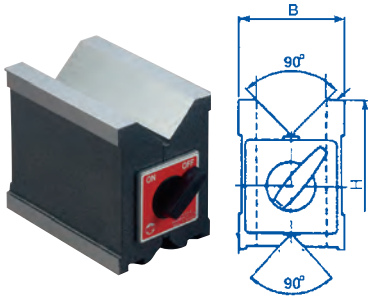

ECE-208 / ECE-212



ECE-612

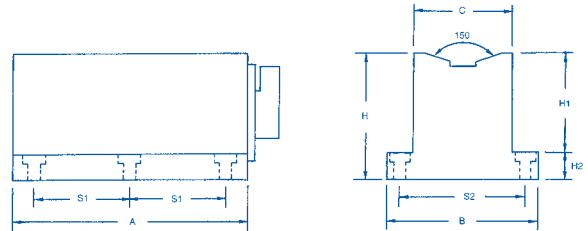

Model	Holding Power		Dimensions (mm)								
	V-Face	Surface	B	L	H	C	H1	H2	S1	S2	Weight
ECE-100	61 lbs.	88 lbs.	100	100	100	-	-	-	-	-	14.5 lbs.
ECE-150	110 lbs.	308 lbs.	150	150	150	-	-	-	-	-	53 lbs.
ECE-208	121 lbs.	154 lbs.	56	80	72	-	-	-	-	-	6.5 lbs.
ECE-212	198 lbs.	242 lbs.	75	115	100	-	-	-	-	-	11 lbs.
ECE-612	242 lbs.	350 lbs.	76	118	62	50	50	12	48	62	5.5 lbs.

## ECE MAGNETIC V-BLOCK SETS

- For grinding, marking, measuring and other light machining operations
- Each pair made to identical dimensions
- Sold in pairs only

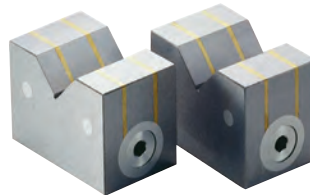

ECE-507

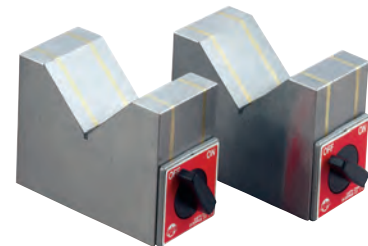

ECE-510

Model	Holding Power	Applicable Diameter (mm)	Dimension mm			Weight
			B	L	H	
ECE-507	33 lbs.	50mm	40mm	72mm	50mm	2.2 lbs. x 2
ECE-510	44 lbs.	80mm	50mm	100mm	80mm	6.6 lbs. x 2

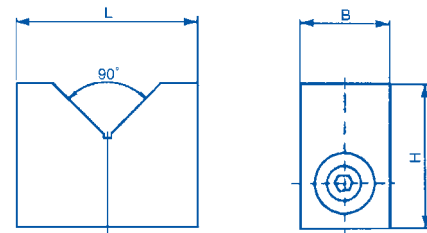

# CHUCK CONTROLS AND DEMAGNETIZERS

## ERD-505, 510, 515 FEATURES:

- Work with any electromagnetic chucks
- Demagnetizing time is 6-15 seconds
- Precisely regulates the magnetic force

## ERD-520 FEATURES:

- For larger, more powerful electromagnetic chucks
- Can operate two chucks at the same time
- Demagnetizing time is 8-15 seconds



ERD-505



ERD-510, ERD-515



ERD-520

Model	Input Voltage/Single Phase	Output Volts	Output Amps	Dim. L x W x H	Wt.
ERD-505-110	AC 110/220V	DC 0-100V	5A	8" x 5.5" x 5"	8 lbs.
ERD-510-220	AC 110/220V	DC 0-120V	10A	6" x 13" x 10"	33 lbs.
ERD-515-220	AC 220V	DC 0-120V	15A	6" x 13" x 10"	44 lbs.
ERD-520-220	AC 220V	DC 0-120V	20A	7" x 15" x 12"	71 lbs.

Please specify voltage when ordering.

## EDH DEMAGNETIZERS



EDH-123

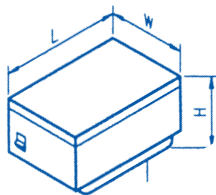

EDH-180

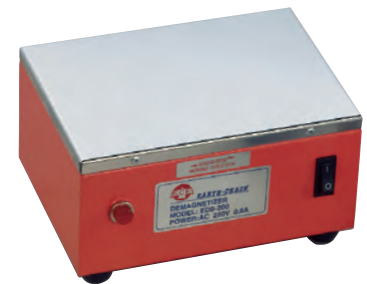
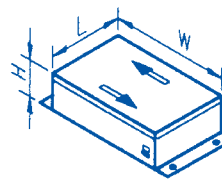

EDH-200

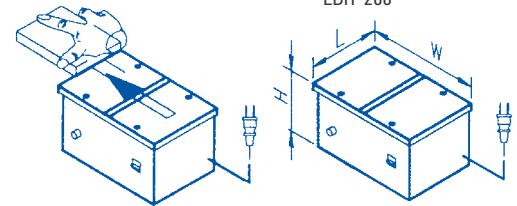

Model	Description	Power	Capacity	Duty Cycle	Dim. L x W x H	Wt.
EDH-123-110	Portable, light weight, for big machines	AC 110V	110V	90%	123 x 83 x 83mm	4 lbs.
EDB-180-110	Up to 20 minutes continuous operation	AC 110/220V	220V	50%	127 x 180 x 90mm	9 lbs.
EDS-200-110	Continuous operation, double-coil design	AC 110V	220V	100%	150 x 200 x 100mm	19 lbs.



# EZ-LIFT ELM MAGNETIC LIFTERS



## FEATURES

- Powerful rare-earth magnets deliver up to 6,600 lbs. of holding power - no electricity required
- Faster setup and transport option than traditional material handling methods
- Will not wear out like straps or slings

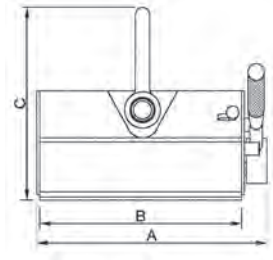
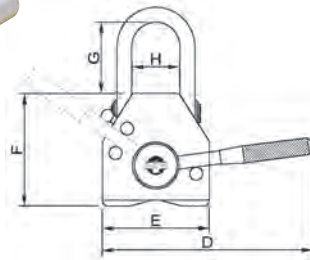

## WHY SWITCH TO EZ-LIFT?

### Risk of Injury

Risk of injury to back, fingers, or toes when moving material in order to position slings or chains.

### Slings & Chains Wear Out

Lifting equipment needs to be recertified and replaced periodically.

### Lost Productivity

It takes time to properly setup slings or chains to safely move materials.

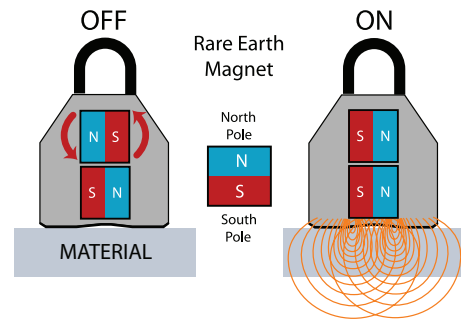
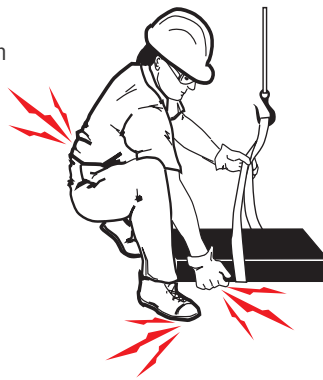

Each ELM lifting magnet contains super powerful rare earth magnets arranged in three rows. Turning the lever to the ON position rotates the center row of magnets 180° so the poles alternate, creating a powerful magnetic field.

Part No.	Plate	Round	A	B	C	D	E	F	G	H	Weight
ELM-100	220 lbs.	132 lbs.	4.2"	3.3"	4.7"	4.9"	2.4"	2.8"	1.6"	1.2"	5.5 lbs.
ELM-300	660 lbs.	400 lbs.	7.1"	6.1"	6.1"	7.3"	3.6"	3.7"	2.0"	1.6"	18.9 lbs.
ELM-600	1,320 lbs.	800 lbs.	10.0"	8.8"	8.3"	10.2"	4.5"	4.7"	3.0"	2.0"	46 lbs.
ELM-1000	2,200 lbs.	1,320 lbs.	11.0"	9.6"	11.3"	14.6"	6.5"	6.7"	3.8"	3.4"	101 lbs.
ELM-2000	4,400 lbs.	2,640 lbs.	16.6"	15.0"	13.7"	20.2"	8.5"	8.5"	4.1"	4.8"	259 lbs.
ELM-3000	6,600 lbs.	3,960 lbs.	22.3"	20.9"	15.7"	30.3"	8.5"	8.7"	5.8"	3.2"	399 lbs.



Workpiece transport is faster with EZ-Lift



Eliminate dangers of other handling methods



Use spreader bar for improved versatility

# EZ-LIFT SPREADER BARS & VERTICAL LIFTERS

## EZ-LIFT SPREADER BARS

- Keeps large or unbalanced materials balanced for safer transport
- Use with multiple magnetic lifters
- Lifter span adjustable

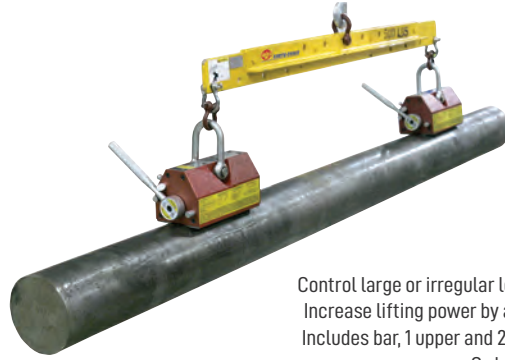
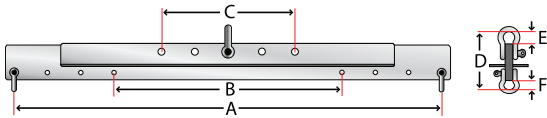

Control large or irregular loads during transport. Increase lifting power by adding more magnets. Includes bar, 1 upper and 2 lower S.P.A. shackles. Order magnets separately.

Part No.	Capacity	A	B	C	D	E	F	Weight
ELM-SB500	500 lbs.	46"	22"	16"	5.7"	1.35"	1.34"	25 lbs.
ELM-SB1000	1,000 lbs.	72"	36"	24"	6.9"	1.35"	1.34"	65 lbs.
ELM-SB2000	2,000 lbs.	72"	36"	24"	7.3"	2.02"	1.35"	115 lbs.
ELM-SB4000	4,000 lbs.	77"	41"	24"	10.5"	2.43"	1.63"	195 lbs.
ELM-SB8000	8,000 lbs.	96"	48"	24"	12.3"	2.94"	1.78"	300 lbs.
ELM-SB10000	10,000 lbs.	116"	56"	24"	14.7"	3.5"	1.65"	600 lbs.
ELM-SB13500	13,500 lbs.	140"	68"	36"	17.1"	4.0"	2.02"	880 lbs.

## EZ-LIFT VERTICAL LIFTERS

- Fast loading for vertical transport
- One person can load and unload
- No dangerous straps & slings



Position lifter on stock and turn the lever to the on position. Hoist into vertical position for transport. Always follow operating instructions included. Used for vertical transport of plate stock. Includes ELM lifting magnet.

Part No.	Size L x W x H	Capacity	Weight	Plate Size L x W x H (min/max)		
				L	W	H
ELM-300V	37.5" x 8.5" x 10"	660 lbs.	57 lbs.	8"/60"	11.8"/31.5"	0.25"/5.9"
ELM-600V	46" x 11" x 10"	1,320 lbs.	86 lbs.	12"/72"	11.8"/39.4"	0.31"/9.8"
ELM-1000V	48" x 14" x 12"	2,200 lbs.	128 lbs.	12.5"/79"	11.8"/39.4"	0.39"/11.8"



Vertical Lifters can be operated by one person



Move round or rectangular stock vertically



Spreader bars are used for long or very heavy loads

# EZ-LIFT MAGNETS / CALCULATING MAXIMUM LOADS

## INSTRUCTIONS FOR CALCULATING MAXIMUM LOAD BY MATERIAL TYPE

$$T \text{ (thickness)} \times F \text{ (finish)} \times M \text{ (material)} \times \text{Capacity} = \text{ML}$$

**Example:** (ELM-600/plate steel) 2" (T=100%) x F2(100%) x M2 (85%) x 1,320 lbs. = **1,122 lbs.**

### CALCULATING MAXIMUM LOADS

Calculate that the magnet will safely lift your material. Maximum Load (ML) is different for plate or round materials, and depends upon stock thickness, carbon content, and surface finish. Use the tables to calculate ML for your material type.

#### M Lifting Power by Material

Carbon Content	0%		50%		100%	
	M1	Low Carbon				100%
M2	Moderate Carbon				85%	
M3	High Carbon				75%	
M4	Cast Iron				70%	

#### F Effect of Surface Finish

Surface Finish	0%		50%		100%		150%	
	F1	Ground Surface						125%
F2	Rough Machined				100%			
F3	Foundry Finish				90%			
F4	~ Rough Cast				65%			

### RATED CAPACITY

Part No.	Plate Steel*
ELM-100	220 lbs.
ELM-300	660 lbs.
ELM-600	1,320 lbs.
ELM-1000	2,200 lbs.
ELM-2000	4,400 lbs.
ELM-3000	6,600 lbs.

Part No.	Round Steel*
ELM-100	132 lbs.
ELM-300	400 lbs.
ELM-600	800 lbs.
ELM-1000	1,320 lbs.
ELM-2000	2,640 lbs.
ELM-3000	3,960 lbs.

### T EQUALS PERCENT OF LIFTING POWER BY T (THICKNESS)

T	ELM-100	ELM-300	ELM-600	ELM-1000	ELM-2000	ELM-3000
2 3/8" (60mm)	100%	100%	100%	100%	100%	100%
2 1/8" (55mm)	100%	100%	100%	100%	100%	95%
2.0" (50mm)	100%	100%	100%	100%	95%	90%
1 3/4" (45mm)	100%	100%	100%	100%	90%	85%
1 1/2" (40mm)	100%	100%	100%	100%	85%	80%
1 3/8" (35mm)	100%	100%	100%	90%	75%	70%
1 1/8" (30mm)	100%	100%	100%	80%	65%	60%
1.0" (25mm)	100%	100%	90%	70%	55%	50%
3/4" (20mm)	100%	90%	75%	60%	45%	40%
1/2" (15mm)	100%	70%	60%	50%	35%	30%
3/8" (10mm)	70%	50%	45%	35%	25%	20%
1/4" (5mm)	40%	30%	25%	20%	15%	10%

\*Follow all directions in the Operating Instructions that comes with your magnet.

### CUSTOM LIFTING SOLUTIONS

Engineered to meet your requirements.  
Call (800) 597-3921 for a fast quote.

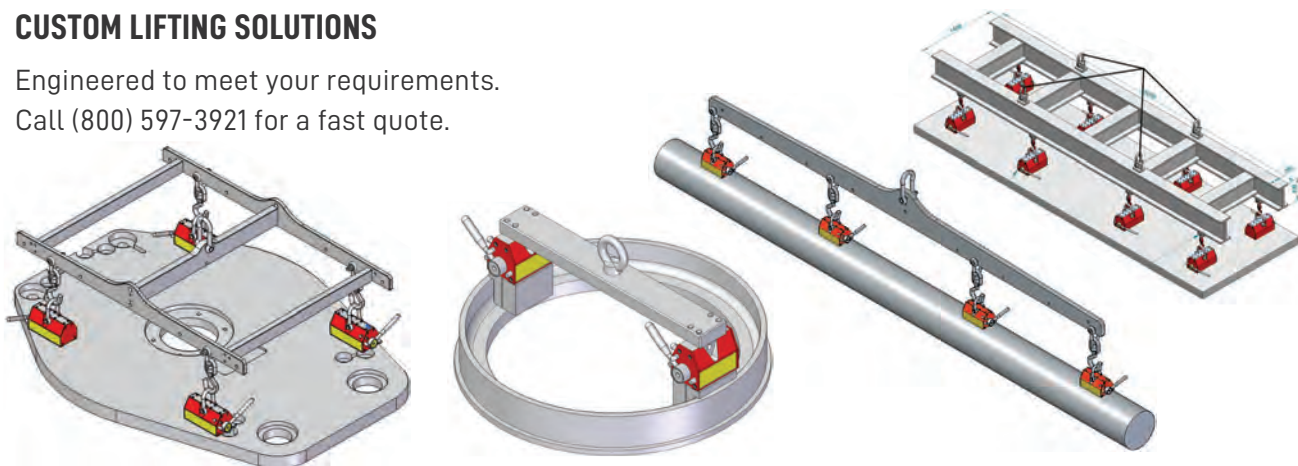



**ELIMINATE  
TIME-CONSUMING  
DEBURRING  
FINISHING & POLISHING**



## **SPINNER MAGNETIC DEBURRING MACHINE**

**DEBURRING | POLISHING | FINISHING**

- Batch deburr all your small, precision parts at once
- Magnetized pin media provides unmatched finish quality
- Deburrs where hand deburring cannot
- Great for irregular parts and small precision parts

**SEND US YOUR PARTS FOR FREE TESTING. SEE THE SPINNER WORK FOR YOU!**



Our deburring specialist will provide a complete report. Includes specific media used & average deburring time.



# SPINNER FEATURES & APPLICATION EXAMPLES

## SPINNER KEY POINTS:

- Deburring is fast and media will not harm part or affect tolerances.
- sPINner media lasts 3-5 years and is safe to handle during operation.
- Parts separator available for high volume needs.
- Does not transfer material, will not introduce new particles to your parts.

## APPLICATIONS INCLUDE:

- Surface polishing
- Pre-electroplating processing
- Removing heat treat scaling
- Oxidized grease/film cleaning
- Removing rust/cleaning threads

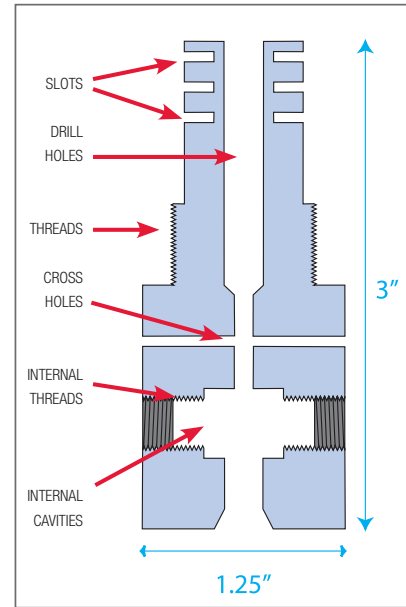

## CASE-STUDY EXAMPLES

### Case 1: Aluminum Gears

**Dimensions** 1 9/16" diameter x 5/16" high

**Problem** Soft material, irregular shape with burrs left in multiple gear gaps and rough edges.

**Deburring Time** 10 minutes.

### BEFORE



### AFTER

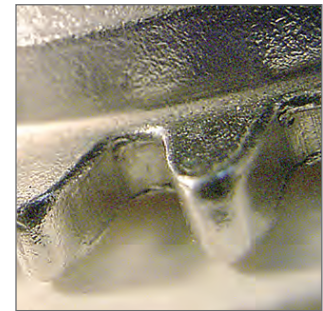

### Case 2: Aluminum Cooling Fins

**Dimensions** 4.75" x 2.125" x 2.75"

**Problem** Soft material with long burrs left in multiple thin slits and rough edges.

**Deburring Time** 15 minutes.

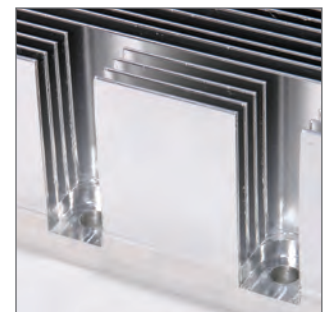

### Case 3: Stainless Steel Turned & Machined Part

**Dimensions** 3/4" diameter x 1 7/16" long

**Problem** Rusty compact cylinder with burrs left in multiple cross-drilled holes.

**Deburring Time** 20 minutes.







Each sPINner includes adjustable speed & intensity controls with programmable timers for each direction.

Speed / Intensity Control with LED display

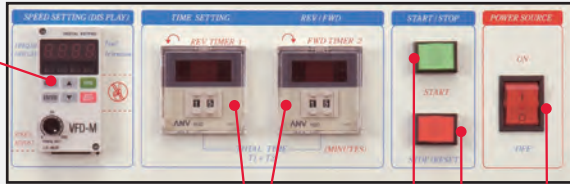

EHD-728 control shown

Programmable Timers (clockwise & counter clockwise)

Cycle Start  
Cycle Stop

Power

## HOW THE SPINNER WORKS

- Powerful magnet located below the sPINner body well creates a rotating magnetic field, stirring the contents within your sPINner tub.
- The tumbling action of the magnetized stainless steel pin media effectively deburrs, smooths rough edges, and polishes your parts for the highest quality finish possible.

## OPERATION PROCEDURE

- Choose the container based on the amount and size of your parts.
- Place a single layer of your parts on the bottom of the container, make sure your parts are not overlapping.
- Mix water & deburring solution for a 50:1 water to solution ratio. (Add more solution for brighter, shiny parts.)
- Secure lid to container.
- Enter cycle time, adjust speed / intensity, and press START. (Note: cycle time, media size, and parts quantity will depend on your application.)



## PARTS & MEDIA SEPARATION PROCEDURE

- Slowly drain water/solution leaving parts and media.
- Place media and parts into the separation container.
- Turn the spin frequency to about 1/2 power. Run machine for about 10 seconds.
- Stop the machine. Your parts should be trapped in the top of the separation container. The pins will be pulled through the separation container to the bottom. (Repeat until media and parts are fully separated.)



# SPINNER MACHINES AND MEDIA



## MACHINES INCLUDE:

- Deburring container
- PFS-747 deburring solution
- Media separator sieve  
Choose media specific to your parts. (see below).

Machine No.	L x W x H	Tank Size L x W	Container W x H	Power Supply	Amps	Weight	Media needed for full charge
EHD-728	19" x 19" x 37"	11" x 11"	9" x 8"	220V single phase	5	160 lbs.	1 kg.
EHD-735	23" x 26" x 34"	15" x 16"	13" x 9"	220V single phase	10	220 lbs.	3 kgs.
EHD-750	29" x 30" x 36"	21" x 23"	19" x 10"	220V single phase	15	385 lbs.	4 kgs.
EHD-765	37" x 39" x 43"	29" x 26.75"	25" x 10"	220V single phase	10	516 lbs.	6 kgs.
EHD-SFS200	12" x 12" 40"	N/A	N/A	110V single phase	5	75 lbs.	-
ESS-660	18" x 18" x 26"	18" x 18"	N/A	110V/220V	15	97 lbs.	-

## SPINNER MEDIA:



- SUS 304 stainless steel pins
- Hardened to HRC 30
- Magnetically treated for enhanced effectiveness

Pin No.	Dia. x Length	Pin No.	Dia. x Length	Pin No.	Dia. x Length
EHD-S1	0.2mm x 5mm	EHD-P5	0.7mm x 3mm	EHD-P10	1.2mm x 3mm
EHD-P1	0.3mm x 3mm	EHD-S5	0.7mm x 5mm	EHD-S8	1.2mm x 5mm
EHD-S2	0.3mm x 5mm	EHD-P6	0.8mm x 3mm	EHD-P42	1.2mm x 10mm
EHD-S13	0.3mm x 7mm	EHD-S6	0.8mm x 5mm	EHD-P9	1.5mm x 3mm
EHD-P2	0.4mm x 3mm	EHD-P7	1.0mm x 1mm	EHD-S9	1.5mm x 5mm
EHD-S3	0.4mm x 5mm	EHD-P8	1.0mm x 3mm	EHD-A3	1.5mm x 7mm
EHD-P3	0.5mm x 1mm	EHD-S7	1.0mm x 5mm	EHD-P43	1.5mm x 10mm
EHD-P4	0.5mm x 3mm	EHD-A1	1.0mm x 7mm	EHD-S10	2.0mm x 5mm
EHD-S4	0.5mm x 5mm	EHD-P41	1.0mm x 10mm		

## USAGE TIPS:

- For hard materials and increase power - Use media 0.5mm diameter or larger.
- For softer materials - Use 0.5mm diameter media or smaller.
- Use 3mm length media for parts with small holes and crevices.
- Always use media with diameters smaller than the holes of your parts.
- For high-volume deburring needs order the 660 Parts & Media Separator.



660 Parts & Media Separator



PFS-747 1-gallon  
PFS-7475G 5-gallon

# PART NUMBER INDEX: 0400 – 04208IS

Part No.	Page	Part No.	Page	Part No.	Page	Part No.	Page	Part No.	Page
00400.....	119	01618-21S.....	71	01630-7/64.....	71	04010-17/64.....	67	04011-1 31/64.....	69
00400/00450-EP.....	119	01618-23/32.....	71	01630-7S.....	71	04010-19/32.....	67	04011-1 5/16.....	69
00450.....	119	01618-23/64.....	71	01630-9/64.....	71	04010-19/64.....	67	04011-1 5/32.....	69
00500.....	120	01618-25/64.....	71	03508-03.....	70	04010-20.....	67	04011-1 5/64.....	69
00600.....	120	01618-27/64.....	71	03508-04.....	70	04010-21/32.....	67	04011-1 7/16.....	69
00600-00165.....	120	01618-29/64.....	71	03508-08.....	70	04010-21/64.....	67	04011-1 7/32.....	69
00600-00166.....	120	01618-3/16.....	71	03508-17/64.....	70	04010-23/32.....	67	04011-1 7/64.....	69
00600-00167.....	120	01618-3/32.....	71	03508-L.....	70	04010-23/64.....	67	04011-1 9/32.....	69
00600-00168.....	120	01618-3/4.....	71	03636-NUT.....	70	04010-25/32.....	67	04011-1 9/64.....	69
00600-9002.....	120	01618-3/8.....	71	03690-25.....	237	04010-25/64.....	67	04011-1/2.....	69
00600-9003.....	120	01618-31/64.....	71	04008-1/2.....	66	04010-27/32.....	67	04011-11/16.....	69
00600-9004.....	120	01618-33/64.....	71	04008-1/4.....	66	04010-27/64.....	67	04011-13/16.....	69
00600-9005.....	120	01618-33S.....	71	04008-1/8.....	66	04010-29/32.....	67	04011-15/16.....	69
00600-9006.....	120	01618-35/64.....	71	04008-11/16.....	66	04010-29/64.....	67	04011-17/32.....	69
01610-1/16.....	71	01618-37/64.....	71	04008-11/32.....	66	04010-3/16.....	67	04011-17/64.....	69
01610-1/2.....	71	01618-39/64.....	71	04008-11/64.....	66	04010-3/32.....	67	04011-17S.....	69
01610-1/4.....	71	01618-41/64.....	71	04008-11S.....	66	04010-3/4.....	67	04011-19/32.....	69
01610-1/8.....	71	01618-41S.....	71	04008-13/32.....	66	04010-3/8.....	67	04011-21/32.....	69
01610-11/32.....	71	01618-43/64.....	71	04008-13/64.....	66	04010-31/32.....	67	04011-23/32.....	69
01610-11/64.....	71	01618-45/64.....	71	04008-15/32.....	66	04010-31/64.....	67	04011-25/32.....	69
01610-13/32.....	71	01618-47/64.....	71	04008-15/64.....	66	04010-33/64.....	67	04011-27/32.....	69
01610-13/64.....	71	01618-5/16.....	71	04008-17/32.....	66	04010-35/64.....	67	04011-29/32.....	69
01610-15/32.....	71	01618-5/32.....	71	04008-17/64.....	66	04010-37/64.....	67	04011-3/4.....	69
01610-15/64.....	71	01618-5/64.....	71	04008-19/32.....	66	04010-39/64.....	67	04011-3/8.....	69
01610-15S.....	71	01618-5/8.....	71	04008-19/64.....	66	04010-41/64.....	67	04011-31/32.....	69
01610-17/32.....	71	01618-7/16.....	71	04008-21/32.....	66	04010-43/64.....	67	04011-33/64.....	69
01610-17/64.....	71	01618-7/32.....	71	04008-21/64.....	66	04010-45/64.....	67	04011-33S.....	69
01610-19/64.....	71	01618-7/64.....	71	04008-22S.....	66	04010-47/64.....	67	04011-35/64.....	69
01610-21/64.....	71	01618-9/16.....	71	04008-23/32.....	66	04010-49/64.....	67	04011-37/64.....	69
01610-21S.....	71	01618-9/32.....	71	04008-23/64.....	66	04010-5/16.....	67	04011-39/64.....	69
01610-23/64.....	71	01618-9/64.....	71	04008-25/64.....	66	04010-5/32.....	67	04011-41/64.....	69
01610-25/64.....	71	01618-9S.....	71	04008-27/64.....	66	04010-5/8.....	67	04011-43/64.....	69
01610-27/64.....	71	01620-1/16.....	71	04008-29/64.....	66	04010-51/64.....	67	04011-45/64.....	69
01610-29/64.....	71	01620-1/4.....	71	04008-3/16.....	66	04010-53/64.....	67	04011-47/64.....	69
01610-29S.....	71	01620-1/8.....	71	04008-3/32.....	66	04010-55/64.....	67	04011-49/64.....	69
01610-3/16.....	71	01620-11/32.....	71	04008-3/4.....	66	04010-57/64.....	67	04011-5/8.....	69
01610-3/32.....	71	01620-11/64.....	71	04008-3/8.....	66	04010-59/64.....	67	04011-51/64.....	69
01610-3/8.....	71	01620-13/64.....	71	04008-31/64.....	66	04010-61/64.....	67	04011-53/64.....	69
01610-31/64.....	71	01620-15/64.....	71	04008-33/64.....	66	04010-63/64.....	67	04011-55/64.....	69
01610-33/64.....	71	01620-17/64.....	71	04008-35/64.....	66	04010-7/16.....	67	04011-57/64.....	69
01610-33S.....	71	01620-17S.....	71	04008-37/64.....	66	04010-7/32.....	67	04011-59/64.....	69
01610-35/64.....	71	01620-19/64.....	71	04008-39/64.....	66	04010-7/64.....	67	04011-61/64.....	69
01610-5/16.....	71	01620-21/64.....	71	04008-41/64.....	66	04010-7/8.....	67	04011-63/64.....	69
01610-5/32.....	71	01620-21S.....	71	04008-43/64.....	66	04010-9/16.....	67	04011-65S.....	69
01610-5/64.....	71	01620-23/64.....	71	04008-43S.....	66	04010-9/32.....	67	04011-7/32.....	69
01610-7/16.....	71	01620-3/16.....	71	04008-45/64.....	66	04010-9/64.....	67	04011-7/8.....	69
01610-7/32.....	71	01620-3/32.....	71	04008-47/64.....	66	04011-1.....	69	04011-9/16.....	69
01610-7/64.....	71	01620-3/64.....	71	04008-5/16.....	66	04011-1 1/16.....	69	04018.....	236
01610-8S.....	71	01620-3/8.....	71	04008-5/32.....	66	04011-1 1/2.....	69	04018-TWA.....	237
01610-9/16.....	71	01620-5/16.....	71	04008-5/8.....	66	04011-1 1/32.....	69	04200MS.....	46
01610-9/32.....	71	01620-5/32.....	71	04008-7/16.....	66	04011-1 1/4.....	69	04201MS.....	46
01610-9/64.....	71	01620-5/64.....	71	04008-7/32.....	66	04011-1 1/64.....	69	04202MS.....	46
01618-1/16.....	71	01620-7/32.....	71	04008-7/64.....	66	04011-1 1/8.....	69	04203MS.....	46
01618-1/2.....	71	01620-7/64.....	71	04008-9/16.....	66	04011-1 11/32.....	69	04204MS.....	46
01618-1/4.....	71	01620-9/32.....	71	04008-9/32.....	66	04011-1 11/64.....	69	04205MS.....	46
01618-1/8.....	71	01620-9/64.....	71	04008-9/64.....	66	04011-1 13/32.....	69	04206MS.....	46
01618-11/16.....	71	01620-9S.....	71	04010-1.....	67	04011-1 13/64.....	69	04207MS.....	46
01618-11/32.....	71	01630-1/16.....	71	04010-1/2.....	67	04011-1 15/32.....	69	04208-01.0.....	46
01618-11/64.....	71	01630-1/4.....	71	04010-1/4.....	67	04011-1 15/64.....	69	04208-01.5.....	46
01618-13/32.....	71	01630-1/8.....	71	04010-1/8.....	67	04011-1 17/64.....	69	04208-02.0.....	46
01618-13/64.....	71	01630-11/64.....	71	04010-11/16.....	67	04011-1 19/64.....	69	04208-02.5.....	46
01618-15/32.....	71	01630-13/64.....	71	04010-11/32.....	67	04011-1 21/64.....	69	04208-03.0.....	46
01618-15/64.....	71	01630-14S.....	71	04010-11/64.....	67	04011-1 23/64.....	69	04208-03.5.....	46
01618-17/32.....	71	01630-15/64.....	71	04010-13/16.....	67	04011-1 25/64.....	69	04208-04.0.....	46
01618-17/64.....	71	01630-3/16.....	71	04010-13/32.....	67	04011-1 27/64.....	69	04208-04.5.....	46
01618-17S.....	71	01630-3/32.....	71	04010-13/64.....	67	04011-1 29/64.....	69	04208-05.0.....	46
01618-19/32.....	71	01630-3/64.....	71	04010-15/16.....	67	04011-1 3/16.....	69	04208-1/16.....	44
01618-19/64.....	71	01630-5/32.....	71	04010-15/32.....	67	04011-1 3/32.....	69	04208-1/8.....	44
01618-21/32.....	71	01630-5/64.....	71	04010-15/64.....	67	04011-1 3/64.....	69	04208-3/16.....	44
01618-21/64.....	71	01630-7/32.....	71	04010-17/32.....	67	04011-1 3/8.....	69	04208IS.....	44



# PART NUMBER INDEX: 04209IS – 04433-13/32

Part No.	Page	Part No.	Page	Part No.	Page	Part No.	Page	Part No.	Page
04209IS	44	04220-07	46	04232-04.5	47	04240-12	47	04294-13	61
04210IS	44	04220-07.5	46	04232-05	47	04240-13	47	04296	61
04211-01.0	46	04220-08	46	04232-05.5	47	04240-13/16	45	04417-03	52
04211-01.5	46	04220-08.5	46	04232-06	47	04240-13/32	45	04417-04	52
04211-02.0	46	04220-09	46	04232-06.5	47	04240-14	47	04417-05	52
04211-02.5	46	04220-09.5	46	04232-07	47	04240-15	47	04417-06	52
04211-03.0	46	04220-1/16	44	04232-07.5	47	04240-15/16	45	04417-07	52
04211-03.5	46	04220-1/2	44	04232-08	47	04240-15/32	45	04417-1/4	52
04211-04.0	46	04220-1/4	44	04232-08.5	47	04240-16	47	04417-1/8	52
04211-04.5	46	04220-1/8	44	04232-09	47	04240-17	47	04417-3/16	52
04211-05.0	46	04220-10	46	04232-09.5	47	04240-17/32	45	04417-5/16	52
04211-05.5	46	04220-10.5	46	04232-1/16	45	04240-18	47	04417-5/32	52
04211-06.0	46	04220-11	46	04232-1/2	45	04240-19	47	04417-7/32	52
04211-06.5	46	04220-11.5	46	04232-1/4	45	04240-19/32	45	04417-9/32	52
04211-07.0	46	04220-11/32	44	04232-1/8	45	04240-20	47	04421-03	52
04211-1/16	44	04220-12	46	04232-10	47	04240-21	47	04421-04	52
04211-1/4	44	04220-12.5	46	04232-10.5	47	04240-21/32	45	04421-05	52
04211-1/8	44	04220-13	46	04232-11	47	04240-22	47	04421-06	52
04211-3/16	44	04220-13.5	46	04232-11.5	47	04240-23	47	04421-07	52
04211-3/32	44	04220-13/32	44	04232-11/16	45	04240-23/32	45	04421-08	52
04211-5/32	44	04220-14	46	04232-11/32	45	04240-24	47	04421-09	52
04211-7/32	44	04220-15/32	44	04232-12	47	04240-25	47	04421-1/4	52
04211-9/32	44	04220-3/16	44	04232-12.5	47	04240-25/32	45	04421-1/8	52
04211IS	44	04220-3/32	44	04232-13	47	04240-26	47	04421-11/32	52
04212IS	44	04220-3/8	44	04232-13.5	47	04240-27/32	45	04421-3/16	52
04213IS	44	04220-5/16	44	04232-13/32	45	04240-29/32	45	04421-3/8	52
04216-01	46	04220-5/32	44	04232-14	47	04240-3/16	45	04421-5/16	52
04216-01.5	46	04220-7/16	44	04232-14.5	47	04240-3/4	45	04421-5/32	52
04216-02	46	04220-7/32	44	04232-15	47	04240-3/8	45	04421-7/32	52
04216-02.5	46	04220-9/32	44	04232-15.5	47	04240-31/32	45	04421-9/32	52
04216-03	46	04225-02	47	04232-15/32	45	04240-5/16	45	04426-03	52
04216-03.5	46	04225-02.5	47	04232-16	47	04240-5/32	45	04426-04	52
04216-04	46	04225-03	47	04232-16.5	47	04240-5/8	45	04426-05	52
04216-04.5	46	04225-03.5	47	04232-17	47	04240-7/16	45	04426-06	52
04216-05	46	04225-04	47	04232-17.5	47	04240-7/32	45	04426-07	52
04216-05.5	46	04225-05	47	04232-17/32	45	04240-7/8	45	04426-08	52
04216-06	46	04225-06	47	04232-18	47	04240-9/16	45	04426-09	52
04216-06.5	46	04225-07	47	04232-18.5	47	04240-9/32	45	04426-1/2	52
04216-07	46	04225-08	47	04232-19	47	04250-06	47	04426-1/4	52
04216-07.5	46	04225-09	47	04232-19.5	47	04250-07	47	04426-10	52
04216-08	46	04225-1/2	45	04232-19/32	45	04250-08	47	04426-11	52
04216-08.5	46	04225-1/4	45	04232-20	47	04250-09	47	04426-11/32	52
04216-09	46	04225-1/8	45	04232-21	47	04250-1	45	04426-12	52
04216-09.5	46	04225-10	47	04232-21/32	45	04250-1/2	45	04426-13	52
04216-1/16	44	04225-11	47	04232-23/32	45	04250-10	47	04426-13/32	52
04216-1/4	44	04225-11/32	45	04232-3/16	45	04250-1-1/4	45	04426-14	52
04216-1/8	44	04225-12	47	04232-3/32	45	04250-12	47	04426-15/32	52
04216-10	46	04225-13	47	04232-3/4	45	04250-14	47	04426-17/32	52
04216-10.5	46	04225-13/32	45	04232-3/8	45	04250-16	47	04426-3/8	52
04216-11/32	44	04225-14	47	04232-5/16	45	04250-18	47	04426-5/16	52
04216-13/32	44	04225-15	47	04232-5/32	45	04250-20	47	04426-7/16	52
04216-3/16	44	04225-15/32	45	04232-5/8	45	04250-22	47	04426-7/32	52
04216-3/32	44	04225-16	47	04232-7/16	45	04250-24	47	04426-9/16	52
04216-3/8	44	04225-17	47	04232-7/32	45	04250-26	47	04426-9/32	52
04216-5/16	44	04225-17/32	45	04232-9/16	45	04250-28	47	04433-03	52
04216-5/32	44	04225-19/32	45	04232-9/32	45	04250-3/4	45	04433-04	52
04216-7/32	44	04225-3/16	45	04240-04	47	04250-30	47	04433-05	52
04216-9/32	44	04225-3/32	45	04240-05	47	04250-32	47	04433-06	52
04220-01	46	04225-3/4	45	04240-06	47	04250-34	47	04433-07	52
04220-01.5	46	04225-3/8	45	04240-07	47	04250-5/8	45	04433-08	52
04220-02	46	04225-5/16	45	04240-08	47	04250-7/8	45	04433-09	52
04220-02.5	46	04225-5/32	45	04240-09	47	04282	61	04433-1/2	52
04220-03	46	04225-5/8	45	04240-1	45	04284	61	04433-1/4	52
04220-03.5	46	04225-7/16	45	04240-1/2	45	04286	61	04433-10	52
04220-04	46	04225-7/32	45	04240-1/4	45	04286-12	61	04433-11	52
04220-04.5	46	04225-9/16	45	04240-1/8	45	04288	61	04433-11/16	52
04220-05	46	04225-9/32	45	04240-10	47	04290	61	04433-11/32	52
04220-05.5	46	04232-03	47	04240-11	47	04292	61	04433-12	52
04220-06	46	04232-03.5	47	04240-11/16	45	04292-22	61	04433-13	52
04220-06.5	46	04232-04	47	04240-11/32	45	04294	61	04433-13/32	52

# PART NUMBER INDEX: 04433-14 – 05320-194

Part No.	Page	Part No.	Page	Part No.	Page	Part No.	Page	Part No.	Page
04433-14	52	04454	61	04544-13	51	04546-3/4	50	04580-20	237
04433-15	52	04455	61	04544-13/32	50	04546-3/8	50	04581	237
04433-15/32	52	04456	61	04544-15/32	50	04546-5/16	50	04587	237
04433-16	52	04457	61	04544-3/16	50	04546-5/8	50	04588-R	237
04433-17	52	04459	61	04544-3/8	50	04546-7/16	50	04593	237
04433-17/32	52	04460	61	04544-5/16	50	04546-7/32	50	04601-16	237
04433-18	52	04461	61	04544-5/32	50	04546-9/16	50	04602-20	237
04433-19	52	04462	61	04544-7/16	50	04546-9/32	50	04603-25	237
04433-19/32	52	04464	61	04544-7/32	50	04546IS	50	04604-32	237
04433-20	52	04466	61	04544-9/32	50	04546MS	51	04605-40	237
04433-21/32	52	04468	61	04544IS	50	04547-06	51	04608	48, 236
04433-23/32	52	04470	61	04544MS	51	04547-07	51	04609	236
04433-3/4	52	04472	61	04545-03	51	04547-08	51	04610	236
04433-3/8	52	04474	61	04545-04	51	04547-09	51	04613	236
04433-5/16	52	04476	61	04545-05	51	04547-1	50	04614	236
04433-5/8	52	04478	61	04545-06	51	04547-1/2	50	04615	236
04433-7/16	52	04480	61	04545-07	51	04547-10	51	04616	236
04433-7/32	52	04482	61	04545-08	51	04547-11	51	04617	236
04433-9/16	52	04484	61	04545-09	51	04547-11/16	50	04618	236
04433-9/32	52	04486	61	04545-1/2	50	04547-12	51	04620	236
04441-03	52	04542-03	51	04545-1/4	50	04547-13	51	04621	236
04441-04	52	04542-03.5	51	04545-10	51	04547-13/32	50	04622	236
04441-05	52	04542-04	51	04545-11	51	04547-14	51	04623	236
04441-06	52	04542-04.5	51	04545-11/32	50	04547-15	51	04624	236
04441-07	52	04542-05	51	04545-12	51	04547-15/32	50	04782	34
04441-08	52	04542-05.5	51	04545-13	51	04547-16	51	04784	34
04441-09	52	04542-06	51	04545-13/32	50	04547-17	51	04786	34
04441-1	52	04542-06.5	51	04545-14	51	04547-17/32	50	04788	34
04441-1/2	52	04542-07	51	04545-15	51	04547-18	51	04790	34
04441-1/4	52	04542-1/4	50	04545-15/32	50	04547-19	51	04801-DE	34
04441-10	52	04542-1/8	50	04545-16	51	04547-19/32	50	04802-C	33
04441-11	52	04542-3/16	50	04545-17/32	50	04547-20	51	04802-DE	34
04441-11/16	52	04542-3/32	50	04545-19/32	50	04547-21/32	50	04803-C	33
04441-11/32	52	04542-5/32	50	04545-3/8	50	04547-23/32	50	04803-DE	34
04441-12	52	04542-7/32	50	04545-5/16	50	04547-25	51	04804-C	33
04441-13	52	04543-03	51	04545-5/8	50	04547-27/32	50	04804-DE	34
04441-13/32	52	04543-04	51	04545-7/16	50	04547-29/32	50	04805-C	33
04441-14	52	04543-05	51	04545-7/32	50	04547-3/4	50	04806-C	33
04441-15	52	04543-06	51	04545-9/16	50	04547-3/8	50	04808-C	33
04441-15/32	52	04543-07	51	04545-9/32	50	04547-31/32	50	04817	32
04441-16	52	04543-08	51	04545IS	50	04547-5/8	50	04818	32
04441-17	52	04543-09	51	04545MS	51	04547-63/64	50	04818-150	32
04441-17/32	52	04543-1/4	50	04546-03	51	04547-7/16	50	04832	32
04441-18	52	04543-1/8	50	04546-04	51	04547-7/8	50	04834	32
04441-19	52	04543-10	51	04546-05	51	04547-9/16	50	04835	32
04441-19/32	52	04543-11/32	50	04546-06	51	04547IS	50	04836-2.5	32
04441-20	52	04543-13/32	50	04546-07	51	04547MS	51	04837	32
04441-21	52	04543-3/16	50	04546-08	51	04548-1	50	04839	32
04441-21/32	52	04543-3/32	50	04546-09	51	04548-1/2	50	04839-140	32
04441-22	52	04543-3/8	50	04546-1/2	50	04548-1/4	50	04841	32
04441-23	52	04543-5/16	50	04546-1/4	50	04548-10	51	04843	32
04441-23/32	52	04543-5/32	50	04546-10	51	04548-1-1/16	50	04851	32
04441-24	52	04543-7/32	50	04546-11	51	04548-1-1/4	50	04854	32
04441-25	52	04543-9/32	50	04546-11/16	50	04548-1-1/8	50	04855	32
04441-26	52	04543IS	50	04546-11/32	50	04548-12	51	04856	32
04441-3/4	52	04543MS	51	04546-12	51	04548-1-3/16	50	04858	32
04441-3/8	52	04544-03	51	04546-13	51	04548-1-3/8	50	04881	33
04441-5/16	52	04544-04	51	04546-13/32	50	04548-14	51	04888	33
04441-5/8	52	04544-05	51	04546-14	51	04548-20	51	04889	33
04441-7/16	52	04544-06	51	04546-15	51	04548-22	51	04891	33
04441-7/32	52	04544-07	51	04546-15/32	50	04548-3/4	50	04892	33
04441-7/8	52	04544-08	51	04546-16	51	04548-3/8	50	04893	33
04441-9/16	52	04544-09	51	04546-17	51	04548-5/8	50	04894	33
04441-9/32	52	04544-1/2	50	04546-17/32	50	04548-7/16	50	04895	33
04448	61	04544-1/4	50	04546-18	51	04548-7/8	50	04896	33
04449	61	04544-1/8	50	04546-19	51	04548IS	50	04897	33
04450	61	04544-10	51	04546-19/32	50	04576	237	04898	33
04451	61	04544-11	51	04546-20	51	04577	237	05320-141	54, 167
04452	61	04544-11/32	50	04546-21/32	50	04578	237	05320-168	54, 167
04453	61	04544-12	51	04546-23/32	50	04580-16	237	05320-194	54, 167





# PART NUMBER INDEX: 05320-220 – 08325-03.5

Part No.	Page	Part No.	Page	Part No.	Page	Part No.	Page	Part No.	Page
05320-220	54, 167	05570-381	54	05728	55	05920-141	59	05956-3.5	49
05320-255	54, 167	05570-429	54	05730	55	05920-168	59	05956-3/16	49
05320-318	54, 167	05570-437	54	05732	55	05920-194	59	05956-3/8	49
05320-323	54, 167	05570-480	54	05734	55	05920-220	59	05958-03	49
05320-367	54, 167	05570-542	54	05736	55	05920-255	59	05958-04	49
05320-381	54, 167	05570-562	54	05738	55	05920IS	59	05958-05	49
05320-5(SET)	54	05570-590	54	05740	55	05925-141	59	05958-06	49
05320-9(SET)	54	05570-652	54	05742	55	05925-168	59	05958-1/2	49
05326	55, 167	05572	55	05744	55	05925-194	59	05958-1/4	49
05330	55, 167	05574	55	05746	55	05925-220	59	05958-1/8	49
05336	55, 167	05576	55	05748	55	05925-255	59	05958-13	49
05342	55, 167	05578	55	05750	55	05925-318	59	05958-20	49
05350	55, 167	05580	55	05752	55	05925-323	59	05958-3.5	49
05352	55, 167	05582	55	05754	55	05925-367	59	05958-3/16	49
05354	55, 167	05584	55	05756	55	05925-381	59	05958-3/4	49
05356	55, 167	05586	55	05758	55	05925IS	59	05958-3/8	49
05371	55, 167	05588	55	05760	55	05932-168	59	06032	39
05385	55, 167	05590	55	05762	55	05932-194	59	06032-3	39
05410-141	54	05592	55	05764	55	05932-220	59	06034	39
05410-168	54	05594	55	05766	55	05932-255	59	06038	39
05410-194	54	05596	55	05768	55	05932-318	59	06040	39
05410-220	54	05598-M9	55	05770	55	05932-323	59	06042	39
05410-255	54	05600	55	05772	55	05932-367	59	06291	26
05410-318	54	05602	55	05802-168	58	05932-381	59	07801	234
05410-323	54	05604	55	05802-194	58	05932-429	59	07806	234
05410-367	54	05606	55	05802-220	58	05932-437	59	07812	234
05410-381	54	05608	55	05802-255	58	05932-480	59	07905-2	239
05410-9(SET)	54	05610	55	05802-4IS	58	05932IS	59	08316-03.0	53
05428	55	05612	55	05804-168	58	05952-02	48	08316-03.5	53
05434	55	05614	55	05804-194	58	05952-03	48	08316-04.0	53
05442	55	05616	55	05804-220	58	05952-03.5	48	08316-04.5	53
05446	55	05618	55	05804-255	58	05952-04	48	08316-05.0	53
05448	55	05620	55	05804-318	58	05952-05	48	08316-05.5	53
05456	55	05622	55	05804-323	58	05952-06	48	08316-06.0	53
05510-11(SET)	54	05624	55	05804-367	58	05952-1/4	48	08316-06.5	53
05510-141	54, 167	05626	55	05804-381	58	05952-1/8	48	08316-07.0	53
05510-168	54, 167	05628	55	05804-8IS	58	05952-3/16	48	08316-07.5	53
05510-194	54, 167	05630	55	0580611IS	58	05954-0.3	48	08316-08.0	53
05510-220	54, 167	05632	55	05806-168	58	05954-0.4	48	08316-08.5	53
05510-255	54, 167	05699-11SET	55	05806-194	58	05954-0.5	48	08316-09.0	53
05510-318	54, 167	05710-141	54	05806-220	58	05954-0.6	48	08316-09.5	53
05510-323	54, 167	05710-168	54	05806-255	58	05954-0.8	48	08316-1/4	53
05510-367	54, 167	05710-194	54	05806-318	58	05954-02	48	08316-10.0	53
05510-381	54, 167	05710-21(SET)	54	05806-323	58	05954-03	48	08316MS	53
05510-429	54, 167	05710-220	54	05806-367	58	05954-04	48	08320-03.0	53
05510-437	54, 167	05710-255	54	05806-381	58	05954-05	48	08320-03.5	53
05510-480	54, 167	05710-318	54	05806-429	58	05954-06	48	08320-04.0	53
05510-542	54, 167	05710-323	54	05806-437	58	05954-07	48	08320-04.5	53
05526	55, 167	05710-367	54	05806-480	58	05954-08	48	08320-05.0	53
05534	55, 167	05710-381	54	05808-15IS	58	05954-09	48	08320-05.5	53
05540	55, 167	05710-429	54	05808-168	58	05954-1.0	48	08320-06.0	53
05542	55, 167	05710-437	54	05808-194	58	05954-1.2	48	08320-06.5	53
05548	55, 167	05710-480	54	05808-220	58	05954-1.25	48	08320-07.0	53
05550	55, 167	05710-542	54	05808-255	58	05954-1.5	48	08320-07.5	53
05554	55, 167	05710-562	54	05808-318	58	05954-1.75	48	08320-08.0	53
05558	55, 167	05710-590	54	05808-323	58	05954-1/4	48	08320-08.5	53
05560	55	05710-652	54	05808-367	58	05954-1/8	48	08320-09.0	53
05562	55	05710-687	54	05808-381	58	05954-10	48	08320-09.5	53
05564	55	05710-697	54	05808-429	58	05954-2.25	48	08320-1/2	53
05566	55	05710-700	54	05808-437	58	05954-2.5	48	08320-1/4	53
05568	55	05710-760	54	05808-480	58	05954-3.5	48	08320-10.0	53
05570-141	54	05710-800	54	05808-542	58	05954-3/16	48	08320-10.5	53
05570-16(SET)	54	05712	55	05808-562	58	05954-3/8	48	08320-11.0	53
05570-168	54	05714	55	05808-590	58	05954-4.5	48	08320-11.5	53
05570-194	54	05716	55	05808-652	58	05956-03	49	08320-12.0	53
05570-220	54	05718	55	05916-141	59	05956-04	49	08320-12.5	53
05570-255	54	05720	55	05916-168	59	05956-05	49	08320-13.0	53
05570-318	54	05722	55	05916-194	59	05956-06	49	08320MS	53
05570-323	54	05724	55	05916-220	59	05956-1/4	49	08325-03.0	53
05570-367	54	05726	55	05916IS	59	05956-1/8	49	08325-03.5	53

# PART NUMBER INDEX: 08325-04.0 – 154080

Part No.	Page	Part No.	Page	0.025 in	Page	Part No.	Page	Part No.	Page
08325-04.0	53	08340-07.5	53	08520-09.5	64	08532-34(SET)	65	141.651.58.295	157
08325-04.5	53	08340-08.0	53	08520-10.0	64	08540-03.5	65	141.651.61.315	157
08325-05.0	53	08340-08.5	53	08520-10.5	64	08540-04.0	65	141.653.54.197	156
08325-05.5	53	08340-09.0	53	08520-11.0	64	08540-04.5	65	141.653.55.197	156
08325-06.0	53	08340-09.5	53	08520-11.5	64	08540-05.0	65	141.653.56.197	156
08325-06.5	53	08340-1	53	08520-12.0	64	08540-05.5	65	141.653.58.217	156
08325-07.0	53	08340-1/2	53	08520-12.5	64	08540-06.0	65	141.653.61.217	156
08325-07.5	53	08340-1/4	53	08520-13.0	64	08540-06.5	65	142.122.16.100	154
08325-08.0	53	08340-10.0	53	08520-20(SET)	65	08540-07.0	65	142.122.25.055	154
08325-08.5	53	08340-10.5	53	08525-03.5	64	08540-07.5	65	142.122.32.057	154
08325-09.0	53	08340-11.0	53	08525-04.0	64	08540-08.0	65	142.151.68.157	158
08325-09.5	53	08340-11.5	53	08525-04.5	64	08540-08.5	65	142.651.52.315	157
08325-1/2	53	08340-12.0	53	08525-05.0	64	08540-09.0	65	142.651.53.315	157
08325-1/4	53	08340-12.5	53	08525-05.5	64	08540-09.5	65	142.651.54.315	157
08325-10.0	53	08340-13.0	53	08525-06.0	64	08540-10.0	65	142.651.56.315	157
08325-10.5	53	08340-13.5	53	08525-06.5	64	08540-10.5	65	142.651.58.315	157
08325-11.0	53	08340-14.0	53	08525-07.0	64	08540-11.0	65	142.651.61.315	157
08325-11.5	53	08340-14.5	53	08525-07.5	64	08540-11.5	65	142.651.64.315	157
08325-12.0	53	08340-15.0	53	08525-08.0	64	08540-12.0	65	143.003	240
08325-12.5	53	08340-15.5	53	08525-08.5	64	08540-12.5	65	143.122.16.100	154
08325-13.0	53	08340-16.0	53	08525-09.0	64	08540-13.0	65	143.122.25.060	154
08325-13.5	53	08340-16.5	53	08525-09.5	64	08540-13.5	65	143.122.32.070	154
08325-14.0	53	08340-17.0	53	08525-10.0	64	08540-14.0	65	143.122.40.065	154
08325-14.5	53	08340-17.5	53	08525-10.5	64	08540-14.5	65	143.123.08.600	154
08325-15.0	53	08340-18.0	53	08525-11.0	64	08540-15.0	65	143.123.11.600	154
08325-15.5	53	08340-18.5	53	08525-11.5	64	08540-15.5	65	143.123.16.600	154
08325-16.0	53	08340-19.0	53	08525-12.0	64	08540-16.0	65	143.123.20.600	154
08325MS	53	08340-19.5	53	08525-12.5	64	08540-16.5	65	143.151.64.100	158
08332-03.0	53	08340-20.0	53	08525-13.0	64	08540-17.0	65	143.151.68.200	158
08332-03.5	53	08340-20.5	53	08525-13.5	64	08540-17.5	65	143.151.72.200	158
08332-04.0	53	08340-21.0	53	08525-14.0	64	08540-18.0	65	143.475.12L.065	159
08332-04.5	53	08340-21.5	53	08525-14.5	64	08540-18.5	65	143.475.12R.065	159
08332-05.0	53	08340-22.0	53	08525-15.0	64	08540-19.0	65	143.476.15L.075	160
08332-05.5	53	08340-22.5	53	08525-15.5	64	08540-19.5	65	143.476.15R.075	160
08332-06.0	53	08340-23.0	53	08525-16.0	64	08540-20.0	65	143.478.08L.065	161
08332-06.5	53	08340-23.5	53	08525-26(SET)	65	08540-20.5	65	143.478.08R.065	161
08332-07.0	53	08340-24.0	53	08532-03.5	64	08540-21.0	65	143.479.16L.075	162
08332-07.5	53	08340-24.5	53	08532-04.0	64	08540-21.5	65	143.479.16R.075	162
08332-08.0	53	08340-25.0	53	08532-04.5	64	08540-22.0	65	143.481.15N.100	160
08332-08.5	53	08340-25.5	53	08532-05.0	64	08540-22.5	65	143.648.06.080	155
08332-09.0	53	08340-26.0	53	08532-05.5	64	08540-23.0	65	143.651.52.300	157
08332-09.5	53	08340-3/4	53	08532-06.0	64	08540-23.5	65	143.651.53.300	157
08332-1/2	53	08340-41MS	53	08532-06.5	64	08540-24.0	65	143.651.54.315	157
08332-1/4	53	08516-03.5	64	08532-07.0	64	08540-24.5	65	143.651.55.315	157
08332-10.0	53	08516-04.0	64	08532-07.5	64	08540-25.0	65	143.651.56.315	157
08332-10.5	53	08516-04.5	64	08532-08.0	64	08540-25.5	65	143.651.58.315	157
08332-11.0	53	08516-05.0	64	08532-08.5	64	08540-26.0	65	143.651.61.335	157
08332-11.5	53	08516-05.5	64	08532-09.0	64	08540-46(SET)	65	143.651.64.335	157
08332-12.0	53	08516-06.0	64	08532-09.5	64	10.780.12.138	116	143.651.68.354	157
08332-12.5	53	08516-06.5	64	08532-10.0	64	103.123.11.100	28	143.651.72.374	157
08332-13.0	53	08516-07.0	64	08532-10.5	64	103.780.12.065	116	143.653.54.217	156
08332-13.5	53	08516-07.5	64	08532-11.0	64	11.780.12.045	116	143.653.55.217	156
08332-14.0	53	08516-08.0	64	08532-11.5	64	1132.0000	49	143.653.56.236	156
08332-14.5	53	08516-08.5	64	08532-12.0	64	1132.0000C	49	143.653.58.236	156
08332-15.0	53	08516-09.0	64	08532-12.5	64	12000-CMS	31	143.653.61.256	156
08332-15.5	53	08516-09.5	64	08532-13.0	64	12040-CMS	31	143.653.64.256	156
08332-16.0	53	08516-10.0	64	08532-13.5	64	12194-ISO25	31	143.653.68.315	156
08332-16.5	53	08516-14(SET)	65	08532-14.0	64	13/0-4036	173	143.653.72.354	157
08332-17.0	53	08520-03.5	64	08532-14.5	64	13/0-4041	173	153250	127
08332-17.5	53	08520-04.0	64	08532-15.0	64	13/0-4048	173	153312	127
08332-18.0	53	08520-04.5	64	08532-15.5	64	13/0-4054	173	153375	127
08332-18.5	53	08520-05.0	64	08532-16.0	64	13/0-4063	173	153500	127
08332-19	53	08520-05.5	64	08532-16.5	64	141.122.16.070	154	153675	127
08332-19.5	53	08520-06.0	64	08532-17.0	64	141.122.25.052	154	153750	127
08332-20.0	53	08520-06.5	64	08532-17.5	64	141.122.32.054	154	154010	126
08332-3/4	53	08520-07.0	64	08532-18.0	64	141.151.64.100	158	154012	126
08332-35MS	53	08520-07.5	64	08532-18.5	64	141.648.06.075	155	154016	126
08340-06.0	53	08520-08.0	64	08532-19.0	64	141.651.54.295	157	154020	126
08340-06.5	53	08520-08.5	64	08532-19.5	64	141.651.55.295	157	154060	126
08340-07.0	53	08520-09.0	64	08532-20.0	64	141.651.56.295	157	154080	126



# PART NUMBER INDEX: 154100 – 19/11-4097

Part No.	Page	Part No.	Page	Part No.	Page	Part No.	Page	Part No.	Page
154100	126	16085	240	16275	26	17048	137	17584B	238
154200	126	16085C-20	41, 115, 240	16277	26	17051	137	17586B	238
154500	126	16087	240	16279	26	17053	137	17706	239
154625	126	16088	240	16281	26	171.02.002.000	241	17707	239
154750	126	16089	240	16283	26	171.05.046.003	140	17708	239
155010	127	16089C-20	41, 115, 240	16284	26	17130-1/2	90	17785B	238
155012	127	16089-LH	240	16285	26	17130-1/4	90	17786B	238
155016	127	16091	240	16289	26	17130-1/8	90	17801	233
155060	127	16091C-20	41, 115, 240	16302	21	17130-3/16	90	17803	233
155080	127	16092	240	16304	21	17130-3/4	90	17805	233
155100	127	16092-15	240	16308	21	17130-3/8	90	17806	233
155125	127	16093	240	16312	21	17130-5/16	90	17808	233
155200	127	16094	240	16313	21	17130-5/8	90	17810	233
155750	127	16096	240	16314	21	17130-7/16	90	17812	233
156100	127	16101	20	16318	21	17130-9/16	90	17814	233
156250	127	16102	20	16321	24	17131	91	17816	233
156375	127	16103	20	16324	24	17132	91	17817	233
156500	127	16104	20	16325	24	17133	91	17818	233
156625	127	16105	20	16328	24	17134	91	17820	233
156750	127	16106	20	16328-200	24	17135	91	17822	233
157010	128	16106-W	20	16329	24	17135-18	91	17824	233
157012	128	16107	20	16330	24	17136	91	17826	233
157014	128	16108-2.5	20	16332	24	17137	91	17828	233
157016	128	16109	20	16456	141	17138	91	17834	233
157018	128	16110	20	16456-W	141	17140-1	91	17836	232
157020	128	16111	20	16466	141	17140-1/2	91	17846B	238
157025	128	16111-90	20	16476	141	17140-1/2-4	92	17852	238
157032	128	16112	20	16502	142	17140-1/2-4.72-RR	92	17854	238
157060	128	16113	20	16504	142	17140-1/2F	93	17856	238
157080	128	16114	20	16506	142	17140-1/4	91	17870	238
157100	128	16115	20	16522	142	17140-1/4-4	92	17872	238
157125	128	16121	20	16523	142	17140-1/4-4.72-RR	92	17883	238
157200	128	16131	20	16524	142	17140-1/4F	93	17884	238
157220	128	16151	22	16542	142	17140-1/8	91	17885	238
157250	128	16151F	23	16543	142	17140-1/8-4	92	17893	238
157500	128	16153	22	16544	142	17140-1/8-5.0-RR	92	17906-04	239
157750	128	16153F	23	16611	148	17140-1-1/2	91	17906-2	239
158250	128	16155	22	16611-4	148	17140-1-1/4	91	18593	93
158312	128	16157	22	16612	148	17140-1-1/4F	93	18851-03	40, 60
158375	128	16157F	23	16614	148	17140-1-5	92	18851-04	40, 60
158500	128	16158	22	16614-2.77	148	17140-1F	93	18851-05	40, 60
158625	128	16159	22	16615	149	17140-3/16	91	18851-05.5	40, 60
158750	128	16159F	23	16615-3/4	149	17140-3/16-4	92	18851-06	40, 60
159100	129	16162	22	16615-4	149	17140-3/16-4.72-RR	92	18851-1/4	40, 60
159125	129	16162F	23	16615-6	149	17140-3/4	91	18851-1/8	40, 60
159200	129	16165	22	16617	149	17140-3/4-4	92	18851-11/64	40, 60
159250	129	16167	22	16620	149	17140-3/4-6-RR	92	18851-12IMS	40, 60
159375	129	16167F	23	16620-4	149	17140-3/4F	93	18851-13/64	40, 60
159500	129	16169	22	16626	149	17140-3/8	91	18851-15/64	40, 60
159750	129	16171	22	16639	149	17140-3/8-4	92	18851-3/16	40, 60
15994G	134	16175	22	16639-3	149	17140-3/8-4.72-RR	92	18851-3/32	40, 60
15995G	134	16177	22	16642	149	17140-3/8F	93	18851-5/32	40, 60
15996G	134	16177F	23	16645	149	17140-5/16	91	18851-7/32	40, 60
16000-2016MC	31	16177S	25	16646	149	17140-5/8	91	18851-7/64	40, 60
16000-2516	31	16179	22	16646-105	149	17140-5/8-4	92	18851-9/64	40, 60
16000-2520	31	16181	22	16646-150	149	17140-5/8F	93	18854	37
16000-BT30-3	241	16181F	23	16648	149	17140-7/16	91	18856	37
16000-BT40-3	241	16183	22	16902C-15	240	17140-7/8-5	92	18866	37
16001	20	16185	22	17.05.046.005	140	17150-1/2	93	18868	37
16001-W	20	16189	22	17001	137	17150-1/4	93	18868-150	37
16010	20	161-BT35-ER32 76	20	17006	137	17150-1-1/4-4.5	93	18869	37
160100	128	16251	26	17010	137	17150-1-4.5	93	19/1 - 4097	173
160750	128	16252	26	17011	137	17150-1-6	93	19/11-4036	172
16080C-20	41, 115, 240	16253	26	17014	137	17150-3/4	93	19/11-4041	172
16081	240	16254	26	17018	137	17150-3/8	93	19/11-4048	172
16081C-20	41, 115, 240	16255	26	17023	137	17150-5/8	93	19/11-4054	172
16082C-20	41, 115, 240	16263	26	17036	137	17385B	238	19/11-4063	172
16083	240	16265	26	17039	137	17386B	238	19/11-4079	172
16083C-20	41, 115, 240	16267	26	17042	137	17386B-35	238	19/11-4095	172
16083-LH	240	16271	26	17046	137	17387B	238	19/11-4097	172

# PART NUMBER INDEX: 19/11-4111 – 22927-4

Part No.	Page	Part No.	Page	Part No.	Page	Part No.	Page	Part No.	Page
19/11-4111.....	172	21480/H100A.....	171	22287-12T.....	15	22711-4.....	144	22913-2.5F.....	79
19/11-4127.....	172	21480/H50A.....	171	22291.....	15	22711-6.....	144	22913-4.72B-RR.....	77
19/11-4142.....	172	21480/H63A.....	171	22291F.....	16	22711-8.....	144	22913-4.72-RR.....	76
19/11-SET.....	172	21480/INC1.....	171	22293.....	15	22713.....	144	22913-6FB.....	78
19/1-4036.....	173	21680/30BT.....	170	22293F.....	16	22713-4.....	144	22913F.....	79
19/1-4041.....	173	21680/40BT.....	170	22295.....	15	22713-6.....	144	22915.....	75
19/1-4048.....	173	21680/40CAT.....	170	22295-10T.....	15	22713-8.....	144	22915-1.75.....	74
19/1-4054.....	173	21680/50BT.....	170	22295-12T.....	15	22715.....	144	22915-2.5.....	75
19/1-4063.....	173	21680/50CAT.....	170	22295F.....	16	22715-4.....	144	22915-2.5B.....	77
19/1-4079.....	173	21680/H100A.....	171	22303.....	15	22715-6.....	144	22915-2.5F.....	79
19/1-4095.....	173	21680/H50A.....	171	22303F.....	16	22715-8.....	144	22915-2.5FB.....	78
19/1-4111.....	173	21680/H63A.....	171	22305.....	15	22717.....	144	22915-4.72B-RR.....	77
19/1-4127.....	173	21680/INC1.....	171	22307.....	15	22717-4.....	144	22915-4.72-RR.....	76
19/1-4142.....	173	21880/40BT.....	170	22307-9.....	15	22719.....	146	22915-4B.....	77
19/1-SET.....	173	21880/40CAT.....	170	22311.....	15	22719-4.....	146	22915-5.....	76
19019-6.....	107	21880/50BT.....	170	22311F.....	16	22721.....	146	22915-5F.....	79
19020-6.....	107	21880/50CAT.....	170	22311S.....	18	22721-10.....	146	22915-5FB.....	78
19022-6.....	107	21880/H100A.....	171	22313.....	15	22721-12.....	146	22915-6.....	76
19026-6.....	107	21880/H63A.....	171	22313F.....	16	22721-14.....	146	22915F.....	79
19028-6.....	107	21880/INC1-1/2.....	171	22317.....	15	22721-3.5.....	146	22916-1.75.....	74
19029.....	107	22213-3.....	10	22317-10T.....	15	22721-5.5.....	146	22916-2.5.....	75
19030-6.....	107	22220.....	236	22317-12T.....	15	22721-8.....	146	22916-2.5F.....	79
19032-6.....	107	22225.....	10	22317F.....	16	22723.....	146	22917.....	75
19034-6.....	107	22225F.....	11	22321.....	15	22723-10.....	146	22917-1.75.....	74
19136-135.....	107	22227.....	10	22321F.....	16	22723-12.....	146	22917-2.5.....	75
19138.....	107	22227F.....	11	22325.....	15	22723-4.....	146	22917-2.5B.....	77
19138-135.....	107	22231.....	10	22327.....	15	22723-6.....	146	22917-2.5FB.....	78
19140.....	107	22231F.....	11	22327-10T.....	15	22723-8.....	146	22917-2.63.....	75
19140-135.....	107	22233.....	10	22327F.....	16	22725.....	146	22917-4.63.....	76
19142.....	107	22233-10.....	10	22331.....	15	22725-10.....	146	22917-4.72B-RR.....	77
19142-135.....	107	22233F.....	11	22335.....	15	22725-12.....	146	22917-4.72-RR.....	76
200TH.....	237	22235.....	10	22337.....	15	22725-3.5.....	146	22917-4B.....	77
2011.0000.....	48	22235F.....	11	22352.....	12	22725-6.....	146	22917-4FB.....	78
2016-2000.....	49	22237.....	10	22354.....	12	22725-8.....	146	22917-6.....	76
2020.0000.....	49	22237F.....	11	22354-6.....	12	22727.....	146	22917-6B.....	77
2020.0000C.....	49	22239.....	10	22354-8.5.....	12	22727-10.....	146	22917B.....	77
21000-CAT40-3.....	241	22239-10.....	10	22356.....	12	22727-4.....	146	22917F.....	79
21000-CAT50-3.....	241	22239-8.....	10	22358.....	12	22727-6.....	146	22919.....	75
21003.....	232	22239F.....	11	22359.....	12	22727-8.....	146	22919-1.75.....	74
21003-45.....	232	22243.....	10	22359-8.....	12	22729.....	146	22919-1.75F.....	79
21003-45C.....	232	22243-2.5.....	10	22360.....	12	22729-4.....	146	22919-1.75FB.....	78
21003-45CSF.....	232	22243F.....	11	22362.....	12	22907.....	75	22919-4B.....	77
21003-60.....	232	22245.....	10	22364.....	17	22907-1.75.....	74	22919B.....	77
21003-60C.....	232	22245F.....	11	22366.....	17	22907-4.72B-RR.....	77	22919F.....	79
21003-60CSF.....	232	22247.....	10	22368.....	17	22907-5.00-RR.....	76	22920.....	75
21003-90.....	232	22247F.....	11	22370.....	17	22907-6.....	76	22920-5.75.....	76
21003-90C.....	232	22251.....	10	22403.....	141	22909.....	75	22920-6FB.....	78
21003-90CSF.....	232	22251F.....	11	22405.....	141	22909-1.75.....	74	22921.....	75
21003-C.....	232	22253.....	10	22511.....	142	22909-4.72B-RR.....	77	22921-1.75.....	74
21005.....	232	22253F.....	11	22512.....	142	22909-4.72-RR.....	76	22921-1.75B.....	77
21005-45.....	232	22253S.....	13	22513.....	142	22909-4B.....	77	22921-1.75F.....	79
21005-45C.....	232	22255.....	10	22515.....	142	22909-6.....	76	22921-3.....	75
21005-60.....	232	22255F.....	11	22521.....	142	22909-6B.....	77	22921-3B.....	77
21005-60C.....	232	22257.....	10	22523.....	142	22909-6FB.....	78	22921-3F.....	79
21005-90.....	232	22257F.....	11	22525.....	142	22911.....	75	22921-3FB.....	78
21005-90C.....	232	22259.....	10	22527.....	142	22911-1.75.....	74	22921-4B.....	77
21005-C.....	232	22259-10.....	10	22529.....	142	22911-2.5.....	75	22921-5.....	76
21006-15.....	232	22259F.....	11	22531.....	142	22911-2.5B.....	77	22921-5F.....	79
21006-15C.....	232	22261.....	10	22611.....	137	22911-2.5F.....	79	22921-6.5.....	76
21007-15.....	232	22261F.....	11	22613.....	137	22911-2.5FB.....	78	22923.....	75
21007-15C.....	232	22263.....	10	22615.....	137	22911-4.72-RR.....	76	22925.....	75
21008-15.....	232	22263F.....	11	22617.....	137	22911-4.75B-RR.....	77	22925-1.75F.....	79
21008-15C.....	232	22265.....	10	22623.....	137	22911-4FB.....	78	22925-3.....	75
21127-C.....	232	22269.....	10	22625.....	137	22911-6.....	76	22925-6.....	76
21148-C.....	232	22281.....	15	22627.....	137	22911-6B.....	77	22925A-1.75.....	74
21480/30BT.....	170	22281F.....	16	22629.....	137	22911-6FB.....	78	22925B.....	77
21480/40BT.....	170	22285.....	15	22709.....	144	22911F.....	79	22925F.....	79
21480/40CAT.....	170	22285F.....	16	22709-4.....	144	22913.....	75	22925FB.....	78
21480/50BT.....	170	22287.....	15	22711.....	144	22913-1.75.....	74	22927.....	75
21480/50CAT.....	170	22287-10T.....	15	22711-2.5.....	144	22913-2.5.....	75	22927-4.....	75



# PART NUMBER INDEX: 22927-6 – 254.40-429

Part No.	Page	Part No.	Page	Part No.	Page	Part No.	Page	Part No.	Page
22927-6	76	22941-7.25T	84	23008	30	25.122.32.090-C	21	254.25-429	56
22927A-2	74	22941-8	84	23014	30	25.122.40.080	21	254.25-437	56
22927B	77	22941-8B	85	23014F	30	25.151.64.200	148	254.25-480	56
22927F	79	22941B	85	23016	30	25.151.68.200	148	254.25-542	56
22929	75	22941F	86	23016F	30	25.151.72.177	148	254.25-6	57
22929F	79	22943	83	23018	30	25.151.77.200	148	254.25-7	57
22931	83	22943-6	84	23018F	30	25.651.54.300	106	254.25-8	57
22931-10BT	85	22943-6B	85	23030	30	25.651.56.300	106	254.25-9	57
22931-10T	84	22943-8	84	23030F	30	25.651.58.300	106	254.32-10	57
22931-2 1/2	82	22943-8B	85	23032	30	25.651.61.300	106	254.32-10.5	57
22931-2.5B	85	22945	83	23034	30	25.651.64.300	106	254.32-11	57
22931-6.5T	84	22945-10BT	85	23035	30	25.653.52.250	90	254.32-11.2	57
22931-6B	85	22945-10T	84	23108	63	25.653.53.250	90	254.32-12	57
22931-8	84	22945-2.62	82	23111	63	25.653.54.250	90	254.32-12.5	57
22931-8B	85	22945-2.62F	86	23116	63	25.653.56.250	90	254.32-13	57
22931B	85	22945-6	84	23120	63	25.653.57.250	90	254.32-14	57
22931F	86	22945-6B	85	23125	63	25.653.58.250	90	254.32-15	57
22933	83	22945-8T	84	23202G	132	25.653.61.250	90	254.32-16	57
22935	83	22945B	85	23203G	132	25.653.64.300	90	254.32-168	56
22935-10BT	85	22945F	86	23204G	132	25077	31	254.32-17	57
22935-10T	84	22946-8	84	23210G	132	253020	125	254.32-18	57
22935-2 1/2	82	22946-8B	85	23214G	132	253750	125	254.32-19	57
22935-2.5B	85	22947	83	23218G	132	254.16-10	57	254.32-194	56
22935-6	84	22947-10BT	85	23222G	132	254.16-168	56	254.32-20	57
22935-6.5T	84	22947-10T	84	23224G	132	254.16-194	56	254.32-220	56
22935-6B	85	22947-2.62	82	23400-30BT	166	254.16-220	56	254.32-255	56
22935-8	84	22947-2.62B	85	23400-40BT	166	254.16-255	56	254.32-318	56
22935-8B	85	22947-6	84	23400-40CAT	166	254.16-318	56	254.32-323	56
22935B	85	22947-6B	85	23400-50CAT	166	254.16-323	56	254.32-367	56
22935F	86	22947-8	84	23400-H63A	166	254.16-367	56	254.32-381	56
22937	83	22947-8B	85	23400-INC1	166	254.16-381	56	254.32-429	56
22937-10BT	85	22947B	85	23410-ER16	166	254.16-6	57	254.32-437	56
22937-10T	84	22947F	86	23410-ER16	166	254.16-6.2	57	254.32-480	56
22937-2 5/8	82	22949	83	23411-MOD	166	254.16-6DIN	57	254.32-542	56
22937-2.625B	85	22949-2	82	23411-MOD	166	254.16-8.5	57	254.32-562	56
22937-6	84	22949B	85	23600-40BT	166	254.16-8DIN	57	254.32-590	56
22937-6.5T	84	22949F	86	23600-40CAT	166	254.16-9	57	254.32-6	57
22937-6B	85	22951	84	23600-50CAT	166	254.20-10	57	254.32-6.2	57
22937-6F	86	22951B	85	23600-H63A	166	254.20-12	57	254.32-6.3	57
22937-8	84	22954-5/16	94	23600-INC1	166	254.20-168	56	254.32-652	56
22937-8B	85	22955-1/4	94	23610-ER25	166	254.20-194	56	254.32-6DIN	57
22937-8F	86	22956-5/16	94	23611-MOD	166	254.20-220	56	254.32-7	57
22937B	85	22957-1/4	94	23616	63	254.20-255	56	254.32-8	57
22937F	86	22957-5/16	94	23620	63	254.20-318	56	254.32-8.5	57
22939	83	22958-5/16	94	23625	63	254.20-323	56	254.32-8DIN	57
22939-1.44	82	22959-3/8	94	23654	36	254.20-367	56	254.32-9	57
22939-10BT	85	22959-5/16	94	23656	36	254.20-381	56	254.40-10	57
22939-10T	84	22959-7/16	94	23658	36	254.20-4.5	57	254.40-10.5	57
22939-3	83	22961-1/2	94	23659	36	254.20-6	57	254.40-11	57
22939-3B	85	22961-5/8	94	23672	36	254.20-8	57	254.40-11.2	57
22939-6	84	22961-7/16	94	23676	36	254.20-9	57	254.40-12	57
22939-6B	85	22961-9/32	94	24.05.046.005	140	254.25-10	57	254.40-12.5	57
22939-7.25T	84	22962-1/2	94	25.122.16.060	21	254.25-10D	57	254.40-13	57
22939-8	84	22963	75	25.122.16.060-C	21	254.25-11	57	254.40-14	57
22939-9/16-1.44	82	22965	75	25.122.16.060-SLOTNUT	21	254.25-12	57	254.40-15	57
22939-9/16-3	82	22967	75	25.122.16.090	21	254.25-12.5	57	254.40-16	57
22939B	85	22969	75	25.122.16.090-C	21	254.25-13	57	254.40-168	56
22939F	86	22971	75	25.122.16.090-SLOTNUT	21	254.25-14	57	254.40-17	57
22941	83	22973	75	25.122.16.105	21	254.25-15	57	254.40-18	57
22941-1.44	82	22975	75	25.122.16-105-C	21	254.25-16	57	254.40-19	57
22941-1.44B	85	22977	75	25.122.20.060	21	254.25-168	56	254.40-194	56
22941-10BT	85	22981	83	25.122.20.060-SLOTNUT	21	254.25-194	56	254.40-20	57
22941-10T	84	22983	83	25.122.20.090	21	254.25-220	56	254.40-220	56
22941-3	83	22985	83	25.122.20.090-SLOTNUT	21	254.25-255	56	254.40-255	56
22941-3B	85	22987	83	25.122.20.105	21	254.25-318	56	254.40-318	56
22941-3F	86	22989	83	25.122.25.060	21	254.25-323	56	254.40-323	56
22941-5.75	84	22990	83	25.122.32.060	21	254.25-367	56	254.40-367	56
22941-6	84	22993	83	25.122.32.060-C	21	254.25-381	56	254.40-381	56
22941-6B	85	22996	83	25.122.32.090	21	254.25-4.5	57	254.40-429	56



# PART NUMBER INDEX: 254.40-437 – 32.780.12.295

Part No.	Page	Part No.	Page	Part No.	Page	Part No.	Page	Part No.	Page
254.40-437	56	258.SFS12.58.315	117	29014B	98	29070	102	31/12-4142	172
254.40-480	56	258.SFS12.58.433	117	29016	96	29070B	104	31/12-4158	172
254.40-542	56	259020	125	29016FB	99	29072	102	31/12-4166C	172
254.40-562	56	259032	125	29018	96	29072B	104	31/12-4174	172
254.40-590	56	259125	125	29018B	98	29074	102	31/12-4190C	172
254.40-6	57	26.122.32.070	22	29020	96	29076	102	31/12-4206C	172
254.40-6.2	57	26.122.32.100	22	29021	96	29103	97	31/12-4209C	172
254.40-6.3	57	26.122.32.150	22	29021F	98	29104	97	31/12-4222C	172
254.40-652	56	26.123.16.070	22	29021FB	99	29106	97	31/12-SET	172
254.40-687	56	26.123.16.150	22	29023	96	29204	97	31/2-4079	173
254.40-697	56	26.651.06.135	108	29023B	98	29206	97	31/2-4095	173
254.40-7	57	26.651.08.135	108	29023FB	99	29208	97	31/2-4111	173
254.40-700	56	26.651.12.090	108	29024	96	29210	97	31/2-4127	173
254.40-760	56	26.651.12.135	108	29025	96	29212	97	31/2-4131C	173
254.40-8	57	26.651.54.600	108	29026	96	29214	97	31/2-4142	173
254.40-8.5	57	26.651.56.600	108	29027	96	29216	97	31/2-4158	173
254.40-800	56	26.651.58.600	108	29027F	98	29218	97	31/2-4166C	173
254.40-9	57	26.651.61.354	108	29027FB	99	29220	97	31/2-4174	173
254020	124	26.651.61.600	108	29029	96	29222	97	31/2-4190	173
254750	124	26.651.64.600	108	29029B	98	29226	97	31/2-4206	173
255032	124	26139-L	119	29030	96	29228	97	31/2-4209C	173
255125	124	263020	125	29032	96	29230	97	31/2-4222	173
255750	124	263750	125	29032FB	99	29232	97	31/2-SET	173
256020	125	264020	124	29033B	98	29234	97	31025F	28
256312	127	264750	124	29034	96	29236	97	31278	27
256750	125	266020	125	29036	96	29238	97	31284	27
257020	125	266750	125	29036B	98	29240	97	31374	27
257750	125	27.151.64.200	149	29036FB	99	29252	103	31374-60-E	28
258.SFS12.03.035	118	27.151.72.400	149	29037	96	29252B	104	31376	27
258.SFS12.03.055	118	27116	49	29037B	98	29254	103	31376-E	28
258.SFS12.03.080	118	27116-30	49	29038	96	29254-8	103	31383-E	28
258.SFS12.03.110	118	27116-40	49	29040	96	29256	103	31384	27
258.SFS12.04.035	118	27116-45	49	29040F	98	29258	103	31385	27
258.SFS12.04.055	118	27116-50	49	29042	96	29258-8	103	31386-E	28
258.SFS12.04.080	118	27116-55	49	29042F	98	29260	103	31402-E	28
258.SFS12.04.110	118	27116-60	49	29042FB	99	29260B	104	31419-E	28
258.SFS12.06.035	118	27116-65	49	29044	96	29262	103	31419-F	28
258.SFS12.06.055	118	28.122.25.100	22	29046	96	29264	103	31420	27
258.SFS12.06.080	118	28.122.32.200	22	29046F	98	29266	103	31430	27
258.SFS12.06.110	118	28.651.03.090	108	29051	102	29266-8	103	31431-F	28
258.SFS12.08.035	118	28.651.04.090	108	29052	102	29268	103	31432	27
258.SFS12.08.055	118	28.651.06.090	108	29052-6	102	29270	103	31434	27
258.SFS12.08.080	118	28.651.08.090	108	29054	102	29272	103	31434-F	28
258.SFS12.08.110	118	28.651.10.090	108	29054-6	102	29274	103	31438	27
258.SFS12.10.035	118	28.651.52.350	108	29054-6B	104	29276	103	31440	27
258.SFS12.10.055	118	28.651.53.350	108	29054-8	102	29278-100	103	31446	27
258.SFS12.10.080	118	28.651.54.350	108	29054-8B	104	29278-160	103	31456-E	28
258.SFS12.10.110	118	28.651.55.350	108	29054B	104	29280	103	31462	27
258.SFS12.12.035	118	28.651.56.350	108	29056	102	29280-160	103	31466	27
258.SFS12.12.055	118	28.651.58.350	108	29058	102	29282	103	31466-8T	27
258.SFS12.12.110	118	28.651.61.350	108	29058-6	102	29827	237	31468	27
258.SFS12.52.055	117	28.651.64.350	108	29058-6B	104	29828	237	31472	27
258.SFS12.52.055-3	117	28.651.68.400	108	29058-8	102	30000	28	31472-E	28
258.SFS12.52.138	117	28.651.72.400	108	29058B	104	30001	28	31476-8T	27
258.SFS12.52.315	117	28110	67	29060	102	30001-L	28	31484	29
258.SFS12.52.433	117	28210	67	29060-6	102	30001-Solid	28	31486	29
258.SFS12.53.055	117	29002	96	29060-6B	104	30002	28	31490	29
258.SFS12.53.138	117	29002FB	99	29060-8	102	30003	28	31492	29
258.SFS12.53.315	117	29004	96	29060B	104	30005	28	31494	29
258.SFS12.53.433	117	29004B	98	29062	102	3003TRK-MF	231	31498	29
258.SFS12.54.055	117	29006	96	29062-6	102	3004TRK-MF	231	31503	29
258.SFS12.54.138	117	29006FB	99	29062-6B	104	300TH	237	31506	29
258.SFS12.54.315	117	29008	96	29062B	104	31.001.92.100	136	31528	97
258.SFS12.54.433	117	29008B	98	29064	102	31.001.92.600	136	31538	97
258.SFS12.56.055	117	29010	96	29064B	104	31.780.12.177	116	31548	97
258.SFS12.56.138	117	29011	96	29066	102	31/12-4079	172	31568	97
258.SFS12.56.315	117	29011F	98	29066-8B	104	31/12-4095	172	31588	97
258.SFS12.56.433	117	29011FB	99	29066B	104	31/12-4111	172	32.001.98.800	136
258.SFS12.58.055	117	29013	96	29068	102	31/12-4127	172	32.001.A2.110	136
258.SFS12.58.138	117	29014	96	29068B	104	31/12-4131C	172	32.780.12.295	116



# PART NUMBER INDEX: 32400/30BT – 44.653.58.600

Part No.	Page	Part No.	Page	Part No.	Page	Part No.	Page	Part No.	Page
32400/30BT	168	33256G	134	385-11878-6	119	39326B	112	43.653.56.300B	81
32400/40BT	168	34400/H100A	169	385-11878-7	119	39327	111	43.653.56.500	80
32400/40CAT	168	34400/H40A	169	385-11878-8	119	39327B	112	43.653.57.300	80
32400/50BT	168	34400/H50A	169	385-11878-9	119	3933040	205	43.653.57.300B	81
32400/50CAT	168	34400/H63A	169	39.05.046.001	140	3934030	184	43.653.58.175B	81
32400/INC1	169	34600/H100A	169	39001-E	113	4001TRK-MF	231	43.653.58.250B	81
32600/30BT	168	34600/H50A	169	39002-E	113	4003TRKC-MF	231	43.653.58.300	80
32600/40BT	168	34600/H63A	169	39004-E	113	4003TRK-MF	231	43.653.58.300B	81
32600/40CAT	168	34905	141	39006-E	113	4004TRKC-MF	231	43.653.58.463	80
32600/50BT	168	34905-F	141	39008-E	113	4005TRKC-MF	231	43.653.58.463B	81
32600/50CAT	168	3533010	183, 204	39014-E	114	4005TRK-MF	231	43.653.61.175B	81
32600/INC1	169	3533020	183, 204	39016-E	114	4008TRKC-MF	230	43.653.61.300	80
32600/INC1-1/2	169	3533030	183, 204	39018-E	114	4008TRK-MF	230	43.653.61.300B	81
32800/40BT	168	3533032	205	39020-E	114	4009TRKC-MF	231	43.653.61.375	80
32800/40CAT	168	3533033	184, 205	39022-E	114	4009TRK-MG	231	43.653.61.375B	81
32800/50BT	168	3533034	205	39024-E	114	4014TRK-MF	231	43.653.61.575	80
32800/50CAT	168	354020	124	39025-E	114	4020TRK-MF	231	43.653.61.575B	81
32800/INC1-1/2	169	35470	38	39082-E	113	4030TRK-MF	230	43.653.64.175	80
32838-4-F	88	35472	38	39084-E	113	40NTRK-MF	230	43.653.64.175B	81
32840-F	88	354750	124	39088-E	113	40TRK-MF	230	43.653.64.350	80
32900/40BT	168	355032	124	39090-E	113	41111	62	43.653.64.350B	81
32900/40CAT	168	355125	124	39092-E	113	41116	62	43.653.64.500	80
32900/50BT	168	3563311	184, 205	39110	107	41120	62	43.653.64.500B	81
32900/50CAT	168	3563336	205	39111	107	41616	62	43.653.68.175	80
32946	88	3563337	205	39113	107	41620	62	43.653.68.175B	81
32946-5	88	3563388	184, 205	39114	107	41625	62	43.653.68.400	80
32947	88	3563399	184, 205	39115	107	41632	62	43.653.68.400B	81
32947-5	88	3564431	205	39117	107	41640	62	43.653.68.600	80
32948	88	3564435	205	39119-4.13	107	41916	62	43.653.72.200	80
32948-5	88	3564438	184	39132	109	41920	62	43.653.72.400	80
32952	88	3564438	205	39134	109	41925	62	43.653.72.400B	81
32952-5	88	3564441	184, 205	39136	109	41925-L	62	43.653.72.460	80
32954	88	3568831	205	39138	109	41932	62	43.653.72.600	80
32954-4	88	3568841	205	39140	109	41940	62	43.653.77.400	80
32954-5	88	3568851	184, 205	39142	109	41950	62	43.653.77.450	80
32956	88	3568861	184, 205	39144	109	42147-ER16	166	44.151.64.100	147
32956-5	88	357750	125	39146	109	42150-25	166	44.151.64.150	147
32958	88	3631083	204	39148	109	42150-50	166	44.151.64.350	147
32958-4	88	364020	124	39150	109	42213-W-50	31	44.151.64.400	147
32958-4-F	88	364750	124	39152	109	42213-W-63	31	44.151.64.550	147
32958-6	88	3663311	184, 204	39154	109	42213-W-90	31	44.151.64.800	147
32962	88	3663336	204	39304	111	42215-W-57	31	44.151.68.100	147
32962-4-F	88	3663337	204	39306	111	42247-ER25	166	44.151.68.200	147
32964	88	3663338	204	39306B	112	42250-100	166	44.151.68.400	147
32978	89	3663339	204	39307	111	42250-50	166	44.151.68.600	147
32978-6	89	3663344	184, 204	39307B	112	42261-W	31	44.151.68.700	147
32982	89	3663399	184, 204	39308	111	42407-W	31	44.151.72.150	147
32982-6	89	3664411	184, 204	39310	111	43.151.64.137	145	44.151.72.350	147
32984	89	3664413	184, 204	39310-6	111	43.151.64.200	145	44.151.72.600	147
32984-6	89	3664416	184, 204	39310B	112	43.151.64.400	145	44.151.77.240	147
32986	89	3664421	204	39311	111	43.151.64.500	145	44.151.77.400	147
32986-6	89	3664422	204	39311B	112	43.151.64.600	145	44.151.77.600	147
32988	89	3664425	204	39312	111	43.151.68.206	145	44.151.77.800	147
32988-6	89	3664427	204	39314	111	43.151.68.400	145	44.151.86.240	147
32992	89	3664429	204	39314B	112	43.151.68.600	145	44.151.86.400	147
32992-6	89	3665525	159	39315	111	43.151.72.221	145	44.463G.64.400	133
32994	89	3668011	184, 204	39315B	112	43.151.72.400	145	44.463G.64.600	133
32994-6	89	3668021	184, 204	39318	111	43.151.72.600	145	44.463G.64.800	133
32996	89	3668026	184, 204	39318B	112	43.151.77.221	145	44.463G.68.400	133
32996-6	89	3732040	205	39319	111	43.151.77.400	145	44.463G.72.413	133
32998	89	3764421	205	39319B	112	43.151.86.240	145	44.463G.72.600	133
32998-6	89	3764424	205	39320	111	43.463G.64.400	133	44.463G.72.800	133
33108	63	3764427	205	39320B	112	43.463G.68.400	133	44.653.52.600	87
33111	63	3768811	205	39321	111	43.463G.72.420	133	44.653.54.400	87
33120	63	3768821	205	39321B	112	43.653.53.300	80	44.653.55.400	87
33125	63	3768826	205	39324	111	43.653.54.300	80	44.653.56.400	87
33125-L	63	38032	239	39324B	112	43.653.54.300B	81	44.653.56.800	87
33232G	134	38036	239	39325	111	43.653.55.300	80	44.653.58.400	87
33236G	134	385-11878-1	119	39325B	112	43.653.55.300B	81	44.653.58.400B	87
33252G	134	385-11878-2	119	39326	111	43.653.56.300	80	44.653.58.600	87

# PART NUMBER INDEX: 44.653.58.800 – 6165102

Part No.	Page	Part No.	Page	Part No.	Page	Part No.	Page	Part No.	Page
44.653.58.800	87	4607261	161	48/3-SET	173	6133277	207	6141297	209
44.653.61.400	87	4607265	161	49001	233	6133280	206	6141300	208
44.653.61.400B	87	4607277	161	49001-45	234	6133282	207	6141302	209
44.653.61.600	87	4608011	161	49003	233	6133285	206	6141305	184, 208
44.653.61.800	87	4608016	161	49005	233	6133287	207	6141307	209
44.653.64.144	87	4608021	161	49011	233	6133290	206	6141310	184, 208
44.653.64.300	87	4608023	161	49013	233	6133292	207	6141312	209
44.653.64.300B	87	4608026	161	49015	233	6133295	206	6141315	184, 208
44.653.64.400	87	4608031	161	49019	234	6133297	207	6141317	209
44.653.64.600	87	46111	62	50001	28	6133300	218	6141320	208
44.653.64.800	87	46116	62	5001TRKC-MF	231	6133305	218	6141322	209
44.653.68.262	87	46120	62	5001TRK-MF	231	6133310	218	6141325	208
44.653.68.400	87	46125	62	5005TRKC-MF	231	6133315	218	6141327	209
44.653.68.600	87	46132	62	5005TRK-MF	231	6134300	206	6141330	208
44.653.68.800	87	46140	62	5014TRCC-MF	231	6134302	207	6141332	209
44.653.72.262	87	47.122.16.400	19	5014TRKC-MF	231	6134305	206	6141335	208
44.653.72.460	87	47.122.16.600	19	5030TRK-MF	230	6134307	207	6141337	209
44.653.72.600	87	47.122.16.800	19	50NTRK-MF	230	6134310	184, 206	6141340	208
44.653.72.800	87	47.122.20.400	19	50TH	237	6134312	207	6141342	209
44.653.77.460	87	47.122.20.600	19	50TRK-MF	230	6134315	184, 206	6141345	208
44.653.77.800	87	47.122.20.800	19	520102	130	6134317	207	6141347	209
44.653.86.600	87	47.122.32.400	19	520104	130	6134320	184, 206	6141350	208, 214, 222
4403502	234	47.122.32.600	19	520108	130	6134322	207	6141352	209
46.122.16.276	14	47.122.32.800	19	520308	130	6134325	206	6141355	208, 214, 222
46.122.16.400	14	47.122.40.400	19	520316	130	6134327	207	6141357	209
46.122.16.600	14	47.122.40.600	19	520508	130	6134330	206	6141360	208, 214, 222
46.122.16.800	14	47.122.40.800	19	520516	130	6134332	207	6141362	209
46.122.20.276	14	47.651.25.100	105	53116	63	6134335	206	6150100	211
46.122.20.400	14	47.651.32.100	105	60/14-4381C	172	6134337	207	6150125	211
46.122.20.600	14	47.651.54.354	105	60/14-4412C	172	6134338	206	6150150	211
46.122.20.800	14	47.651.56.394	105	60/14-4444C	172	6134340	207	6150175	211
46.122.32.276	14	47.651.58.394	105	60/14-4476C	172	6140100	210	6150200	211
46.122.32.400	14	47.651.58.600	105	6011000	189	6140125	210	6150225	211
46.122.32.600	14	47.651.61.394	105	6011050	189	6140150	210	6150250	211
46.122.32.800	14	47.651.64.413	105	6011100	189	6140175	210	6150275	211
46.122.40.315	14	47.651.68.413	105	6011150	189	6140200	210	6150300	211
46.122.40.600	14	47.651.72.413	105	6011200	189	6140225	210	6150325	211
46.122.40.800	14	48/13-4127	172	6011250	189	6140250	210	6150350	211
46.651.03.400	100	48/13-4142	172	6011300	189	6140275	210	6150375	184, 211
46.651.03.600	100	48/13-4158	172	6022510	214, 222	6140300	210	6150400	184, 211
46.651.04.300	100	48/13-4166C	172	6033311	216	6140325	210	6150425	184, 211
46.651.06.300	100	48/13-4174	172	6033322	216	6140350	210	6150450	211
46.651.06.600	100	48/13-4190	172	6033333	216	6140375	210	6150475	211
46.651.08.300	100	48/13-4206	172	6033344	217	6140400	184, 210	6150500	211
46.651.10.300	100	48/13-4209C	172	6033355	217	6140400	210	6150525	211
46.651.52.400B	101	48/13-4222	172	6033366	217	6140425	184, 210	6150550	211
46.651.53.400B	101	48/13-4238	172	6033377	217	6140450	184, 210	6150575	211
46.651.53.600B	101	48/13-4254	172	6033388	217	6140475	210	6150600	211, 214, 222
46.651.54.350	100	48/13-4264C	172	6033399	217	6140500	210	6150625	211, 214, 222
46.651.54.400B	101	48/13-4286	172	6123300	218	6140525	210	6150650	211, 214, 222
46.651.54.600B	101	48/13-4317	172	6123305	218	6140550	210	6155101	211
46.651.55.300B	101	48/13-4332C	172	6123310	218	6141250	208	6155102	211
46.651.55.375B	101	48/13-4349	172	6123315	218	6141252	209	6155103	211
46.651.56.375	100	48/13-SET	172	6123320	218	6141255	208	6155104	212
46.651.56.375B-2.5	101	48/3-4127	173	6130100	210	6141257	209	6155105	184, 212
46.651.56.400B	101	48/3-4142	173	6130150	210	6141260	208	6155106	212
46.651.57.300B	101	48/3-4158	173	6130200	210	6141262	209	6155107	212
46.651.58.315B	101	48/3-4166C	173	6130250	210	6141265	208	6155108	214, 222
46.651.58.375	100	48/3-4174	173	6130300	210	6141267	209	6155501	212
46.651.58.375B	101	48/3-4190	173	6133250	206	6141270	208	6155502	212
46.651.59.300B	101	48/3-4206	173	6133252	207	6141272	209	6155503	212
46.651.61.300B	101	48/3-4209C	173	6133255	206	6141275	208	6155504	212
46.651.64.400	100	48/3-4222	173	6133257	207	6141277	209	6155531	212
46.651.64.400B	101	48/3-4238	173	6133260	206	6141280	208	6155632	212
46.651.64.600B	101	48/3-4254	173	6133262	207	6141282	209	6155633	212
46.651.68.400	100	48/3-4264C	173	6133265	206	6141285	208	6155634	212
46.651.72.400	100	48/3-4286	173	6133267	207	6141287	209	6155635	184, 212
4600076	161	48/3-4317	173	6133270	206	6141290	208	6155636	212
4601437	161	48/3-4332C	173	6133272	207	6141292	209	6165101	212
4607257	161	48/3-4349	173	6133275	206	6141295	208	6165102	212



# PART NUMBER INDEX: 6165103 – 6972236

Part No.	Page	Part No.	Page	Part No.	Page	Part No.	Page	Part No.	Page
6165103	184, 212	6275276	200	6390253	201	6551012	214, 222	6711275	190
6165121	213	6275280	196	6390255	198	6551080	214, 222	6722225	190
6165122	213	6275281	200	6390258	201	6552220	216	6722235	190
6165123	184, 231	6275285	196	6390260	198	6552230	216	6722245	190
6165141	213	6275290	196	6390265	198	6552730	216	6722255	190
6165142	213	6275295	196	6390266	201	6552745	216	6722265	190
6165143	213	6275296	200	6390270	198	6553235	216	6722275	190
6165144	184, 213	6275300	196	6390275	198	6553252	216	67250	106
6165341	213	6275305	196	6390276	201	6554240	216	6733225	191
6165342	213	6275310	196	6390280	198	6554260	216	6733227	191
6165343	184, 213	6275311	200	6390285	198	6555450	184, 216	6733230	191
6165801	213	6275315	196	6390290	198	6555475	184, 216	6733232	191
6165802	213	6275320	196	6390291	201	6556860	216	6733235	191
6165803	213	6275325	196	6390295	198	6556890	216	6733237	191
6165804	213	6275326	200	6390300	198	6558510	216	6733245	191
6165805	184, 213	6275330	196	6390305	198	6558570	216	6733247	191
6166123	211, 214, 222	6275335	196	6390306	201	6561080	216	6733255	191
6166124	208, 214, 222	6275340	197	6390310	198	6562230	216	6733257	191
6166125	212, 214, 222	6275341	200	6390315	198	6562730	216	6733265	190
620104	130	6275345	197	6390320	198	6563235	216	6733267	191
620108	130	6275350	197	6390321	201	6564240	216	67375	106
620316	130	6275355	197	6390325	198	6565450	184, 216	67500	106
620516	130	6275356	200	6390330	198	6566860	216	67625	106
625102	130	6275360	197	6390335	198	6568570	216	67750	106
625104	130	6275365	197	6390336	201	6601436	159, 205	6921234	180, 182, 218, 221
625108	130	6275370	197	6390340	198	6601437	205	6921235	179, 180, 181, 182
625308	130	6275371	200	6390345	198	6601446	159, 205	6921236	179, 180, 181, 183
625316	130	6275375	197	6390350	198	6602011	159	6921237	179, 181
625508	130	6275380	197	6390351	201	6602022	159	6921237	181, 183
625516	130	632100	130	6390355	198	6607029	159, 205	6921238	182, 183
625716	130	632102	130	6390360	198	6607033	159, 205	6921239	177, 178, 180
6275100	192	632104	130	6390365	199	6607037	159, 205		181, 182, 183
6275105	192	632108	130	6390366	201	6607045	159	6921240	180, 181, 182, 183
6275115	192	632304	130	6390370	199	6607901	159, 204	6921241	177, 178, 180
6275120	192	632308	130	6390375	199	6607905	159, 204		181, 182, 183
6275125	192	632316	130	6390380	199	6608011	159, 205	6921242	180, 181, 182, 183
6275130	192	632508	130	6390381	201	6608016	159, 205	6921243	180, 181, 182, 183
6275135	192	632516	130	6390385	199	6608021	159, 205	6921245	221
6275140	192	632787	130	6390390	199	6608026	159, 205	6921255	221
6275145	192	632984	130	6390395	199	6608031	159	6921256	221
6275150	192	6390100	194	6390396	201	6608036	159	6921257	221
6275155	192	6390105	194	6390400	199	6675125	202	6921258	221
6275160	192	6390110	194	6390405	199	6675126	202	6921259	221
6275165	192	6390115	194	6390410	218	6675130	202	6921260	221
6275170	192	6390120	194	64.05.046.051	140	6675135	202	6921261	221
6275175	192	6390125	194	64110	115	6675140	202	6921262	221
6275180	192	6390130	194	64250	115	6675141	202	6922243	177, 179, 180, 221
6275185	192	6390135	194	64375	115	6675145	202	6942234	177, 179, 181, 183
6275190	192	6390140	194	6442210	217	6675150	202	6942235	177, 179, 181, 183
6275195	192	6390145	194	6442236	217	6690125	203	6942236	177, 179, 181, 183
6275200	192	6390150	194	6442240	217	6690126	203	6942237	177, 179, 181, 183
6275205	192	6390155	194	6442258	217	6690130	203	6942238	177, 179, 181, 183
6275210	193	6390160	194	6442286	217	6690135	203	6942239	179, 181, 183
6275215	193	6390165	194	6442734	217	6690140	203	6943333	176, 178, 180, 182
6275220	193	6390170	194	6442750	217	6690141	203	6943334	176, 178, 180, 182
6275225	193	6390175	194	6442780	217	6690145	203	6943335	176, 178, 180, 182
6275230	193	6390180	194	6442795	217	6690150	203	6943336	176, 178, 180, 182
6275235	193	6390185	194	6443246	217	6690155	203	6943337	176, 178, 180, 182
6275240	193	6390190	194	6443276	217	6690160	203	6943338	178, 180, 182
6275245	193	6390200	194	6443290	217	6690165	203	6951234	176, 177, 178, 179
6275250	193	6390205	194	6444270	217	6690170	203		180, 181, 182, 183
6275253	200	6390210	195	6444282	217	6690175	203	6962233	176, 177, 178, 179
6275255	196	6390215	195	6444295	217	6690180	203	6962235	176, 177, 178, 179
6275258	200	6390220	195	6445472	217	6690190	218		180, 181, 182, 183
6275260	195	6390225	195	6445490	217	67.05.046.001	140	6962236	177, 178, 179
6275263	200	6390230	195	6446810	217	6711225	190		180, 181, 182, 183
6275265	195	6390235	195	6448510	217	6711235	190	6962238	178, 179, 180
6275270	196	6390240	195	64500	115	6711245	190		181, 182, 183
6275271	200	6390245	195	64625	115	6711255	190	6972215	177, 178, 179, 180
6275275	196	6390250	195	64750	115	6711265	190		181, 182, 183
								6972236	176, 178, 182

# PART NUMBER INDEX: 6972237 – 99588

Part No.	Page	Part No.	Page	Part No.	Page	Part No.	Page	Part No.	Page
6972237	176, 177, 178, 179	83508-5/16	70	84063-19/32	68	84127-12	135	93115	109
	180, 182, 183	83508-NUT	70	84063-19/64	68	84127-13	135	93115-6B	110
6972238	177, 179, 180	83512-1/2	70	84063-21/32	68	84127-13/16	135	93115B	110
	182, 183	83512-1/4	70	84063-21/64	68	84127-14	135	93116	109
6991210	177	83512-1/8	70	84063-23/32	68	84127-16	135	93117	109
6991215	176	83512-10	70	84063-23/64	68	84127-17/32	135	93117-6B	110
6991220	179	83512-3/16	70	84063-25(SET)	68	84127-18	135	93117B	110
6991230	182	83512-3/8	70	84063-25/32	68	84127-20	135	93118	109
6991235	178	83512-5/16	70	84063-27/32	68	84127-23	135	93119	109
6991240	182	83512-7/16	70	84063-27/64	68	84127-23/32	135	93119-6B	110
6991245	183	83531-11	70	84063-29/32	68	84127-25	135	93119B	110
6991250	180	83531-02	70	84063-29/64	68	84127-25/32	135	93120	109
71010	114	83531-03	70	84063-3/16	68	84127-26	135	93121	109
71011	114	83531-04	70	84063-3/32	68	84127-3/16	135	93121-6B	110
71100	114	83531-05	70	84063-3/4	68	84127-3/4	135	93121B	110
71250	114	83531-06	70	84063-3/8	68	84127-3/8	135	93124	109
71312	114	83531-07	70	84063-31/32	68	84127-33/64	135	93124-6B	110
71375	114	83531-08	70	84063-31/64	68	84127-41/64	135	93124B	110
71500	114	83531-09	70	84063-33/64	68	84127-49/64	135	93126	109
71625	114	83531-1/2	70	84063-39/64	68	84127-5/16	135	93126-6B	110
71750	114	83531-1/4	70	84063-41/64	68	84127-5/8	135	93128	109
73.001.98.600	136	83531-1/8	70	84063-43/64	68	84127-7/16	135	93130	109
73.001.A2.100	136	83531-10	70	84063-47/64	68	84127-7/8	135	93135	109
73.780.12.075	116	83531-12	70	84063-49/64	68	84127-9/16	135	93140	109
73528	110	83531-13	70	84063-5/16	68	84128-1/2	135	93145	109
73538	110	83531-14	70	84063-5/32	68	84128-1/4	135	93500	150
73548	110	83531-15	70	84063-5/8	68	84128-1/8	135	93501	150
73568	110	83531-16	70	84063-51/64	68	84128-3/16	135	93502	150
73588	110	83531-3/16	70	84063-53/64	68	84128-3/4	135	93502-F	150
75.001.99.100	136	83531-3/8	70	84063-55/64	68	84128-3/8"	135	93509-F	150
75.780.12.105	116	83531-5/16	70	84063-57/64	68	84128-5/16	135	93510	150
750-19	234	83531-5/8	70	84063-57S	68	84128-5/8	135	93510-8	150
7582401	151	83531-7/16	70	84063-59/64	68	84128-7/16	135	93510-F	150
7582402	151	83531-9/16	70	84063-61/64	68	84128-7/8	135	93520	150
7582403	151	83632	70	84063-63/64	68	84128-9/16	135	93520-6	150
7607069	160	83634	70	84063-7/16	68	84193G	236	93520-8	150
7607073	160	83634-L	70	84063-7/32	68	854022	126	93520-F	150
7607077	160	83691	236	84063-7/64	68	854024	126	93530	150
7608021	160	83868-1	70	84063-7/8	68	854028	126	93530-6	150
7608026	160	83868-1/2	70	84063-9/16	68	854030	126	93530-8	150
7608029	160	83868-1/4	70	84063-9/32	68	854032	126	93530-F	150
7608031	160	83868-1/8	70	84063-9/64	68	854034	126	93550	150
820030	130	83868-10	70	84126-06	135	854036	126	93550-F	150
820040	130	83868-16	70	84126-08	135	854038	126	95901	151
820050	130	83868-20	70	84126-1/2	135	854040	126	95901-12	151
820060	130	83868-25	70	84126-1/4	135	854042	126	95901-4	151
820080	130	83868-3/16	70	84126-1/8	135	86062	115	95901-6	151
820100	130	83868-3/4	70	84126-10	135	86064	115	95903	151
820120	130	83868-3/8	70	84126-11/32	135	86066	115	95903-10	151
820140	130	83868-5/16	70	84126-12	135	8607241	162	95903-12	151
820160	130	83868-5/8	70	84126-14	135	8607245	162	95903-14	151
82150	140	83868-7/16	70	84126-15/32	135	86076	115	95903-6	151
82151-JT33	140	83868-7/8	70	84126-16	135	8607921	162	95903-7	151
82153	140	83868-9/16	70	84126-17/64	135	8607925	162	95905	151
82153-JT33	140	84012	66	84126-25/64	135	86080	115	95905-6	151
82164	141	84063-1	68	84126-3/16	135	8608011	162	95905-9	151
82172	141, 236	84063-1/2	68	84126-3/8	135	8608016	162	95907	151
832060	130	84063-1/4	68	84126-37/64	135	86090	115	95907-10	151
832080	130	84063-1/8	68	84126-5/16	135	86092	115	95907-15	151
832100	130	84063-11/16	68	84126-5/8	135	86094	115	95907-4	151
832120	130	84063-11/32	68	84126-7/16	135	894-22	49, 236	95907-6	151
832140	130	84063-11/64	68	84126-9/16	135	894-36	236	9851125	152, 158
832160	130	84063-13/16	68	84126-9/32	135	92002	29, 240	9851135	152, 158
832180	130	84063-13/32	68	84127-08	135	92003	29, 240	9851135	158
832200	130	84063-13/64	68	84127-1	135	92004	29, 38, 240	99.780.12.075	116
832250	130	84063-15/16	68	84127-1/2	135	92005	29, 240	99528	113
83508-0.109	70	84063-15/32	68	84127-1/4	135	93.05.046.003	140	99538	113
83508-1/4	70	84063-15/64	68	84127-1/8	135	93.11.026.004	38	99548	113
83508-1/8	70	84063-17/32	68	84127-10	135	93113B	110	99568	113
83508-3/16	70	84063-17/64	68	84127-11/16	135	93114B	110	99588	113
83508-3/8	70								





# PART NUMBER INDEX: BD-TH-1031 – WF2

Part No.	Page	Part No.	Page	Part No.	Page	Part No.	Page	Part No.	Page
BD-TH-1031	240	ECE-330B	242	EPM-5060B	246	EET-2045W	264	ELM-SB2000	269
BD-TH-1062	240	ECE-340	242	EPM-5060D-480	248	EET-2050	263	ELM-SB4000	269
BD-TH-1063	240	ECE-507	266	EPM-5080B	246	EET-2050W	264	ELM-SB500	269
CAT40ER11-3	138	ECE-510	266	EPM-5080D-480	248	EET-2550	263	ELM-SB8000	269
CAT40ER11-4	138	ECE-612	266	EPM-5090B	246	EET-2550W	264	ERD-505-110	267
CAT40ER11-6	138	EDB-180-110	267	EPM-600IT	257	EET-3060	263	ERD-510-220	267
CAT40ER16-2.76	138	EDH-123-110	267	EPM-60100B	246	EET-3060W	264	ERD-515-220	267
CAT40ER16-4	138	EDMT-1018	261	EPM-6060B	246	EET-3070	263	ERD-520-220	267
CAT40ER20-2.76	138	EDMT-1325	261	EPM-6060D-480	248	EET-3090	263	ESS-660	274
CAT40ER20-4	138	EDMT-1530	261	EPM-6080B	246	EET-40100	263	H100-40TB349	241
CAT40ER20-6	138	EDMT-1535	261	EPM-6080D-480	248	EET-4060	263	H63A-40TB346	241
CAT40ER25-2.76	138	EDMT-1545	261	EPM-6090B	246	EET-4070	263	M50TRK-MF	230
CAT40ER25-4	138	EDMT-2040	261	EPM-800IT	257	EET-4080	263	MAK050TRK-MF	231
CAT40ER32-2.76	138	EDMT-2045	261	EPM-800V2	253	EET-50100	263	NT-54300130	31
CAT40ER32-4	138	EDMT-2050	261	EPM-800V4	253	EET-50150	263	NTS-40-TAPER	238
CAT40ER40-3.15	138	EDMT-2550	261	EPM-8080B	246	EET-60100	263	NTS-BT30-38	238
CAT40SLN1	139	EDMT-3060	261	EPM-8080D-480	248	EET-60150	263	NTS-BT30-41	238
CAT40SLN1/2	139	EDS-200-110	267	EPM-950PIM	258	EET-80100	263	NTS-BT30-SLOT	238
CAT40SLN1/2-1.75	139	EDTW-1018	262	EPM-C4C	251	EHD-728	274	NTS-HSK63A	238
CAT40SLN1/4	139	EDTW-1325	262	EPM-CC05	251	EHD-735	274	NTS-HSK63F-36	238
CAT40SLN1/4-1.75	139	EDTW-1515	262	EPM-CC10	251	EHD-750	274	NTS-HSK63F-38	238
CAT40SLN1/8	139	EDTW-1530	262	EPM-CC15	251	EHD-765	274	NTS-HSK63F-41	238
CAT40SLN1-1.75	139	EDTW-1535	262	EPM-CIR1000	255	EHD-A1	274	NTS-HSK63F-46	238
CAT40SLN1-1/4	139	EDTW-1545	262	EPM-CIR1250	255	EHD-A3	274	NTS-ISO20-17	238
CAT40SLN3/16	139	EDTW-2040	262	EPM-CIR1500	255	EHD-P1	274	NTS-ISO20-22	238
CAT40SLN3/4	139	EDTW-2045	262	EPM-CIR1600	255	EHD-P10	274	NTS-ISO25-27	238
CAT40SLN3/4-1.75	139	EDTW-2050	262	EPM-CIR1800	255	EHD-P2	274	NTS-ISO30-36	238
CAT40SLN3/8	139	EDTW-2550	262	EPM-CIR2000	255	EHD-P3	274	NTS-ISO30-38	238
CAT40SLN3/8-1.75	139	EPM-1200PIM	258	EPM-CIR500	255	EHD-P4	274	NTS-ISO30-47	238
CAT40SLN5/8	139	EPM-1530A	249	EPM-CIR600	255	EHD-P41	274	P40-20TB12	241
CAT50ER16-4	138	EPM-2030C	251	EPM-CIR800	255	EHD-P42	274	P50-20TB12	241
CAT50ER16-6	138	EPM-20T	255	EPM-CIRIB120	255	EHD-P43	274	PSC-50	237
CAT50ER20-4	138	EPM-25100B	246	EPM-CIRIB170	255	EHD-P5	274	PSS-30BT	237
CAT50ER20-6	138	EPM-2525C	251	EPM-CIRIB220	255	EHD-P6	274	PSS-30ISO	237
CAT50ER32-4	138	EPM-2530C	251	EPM-CIRIB245	255	EHD-P7	274	PSS-40	237
CAT50ER32-6	138	EPM-2540A	249	EPM-CIRIB270	255	EHD-P8	274	T20L3TKIA81F	36, 38
CAT50ER40-4	138	EPM-2540B	246	EPM-CIRIB335	255	EHD-P9	274	T20SOTK1A81F	36, 38
CAT50SLN1	139	EPM-2560A	249	EPM-CIRIB350	255	EHD-S1	274	TE-22HN	13, 18, 25
CAT50SLN1/2	139	EPM-2560B	246	EPM-CIRIB355	255	EHD-S10	274	TOY050TRK-MF	231
CAT50SLN1/4	139	EPM-2580B	246	EPM-CIRIB355	255	EHD-S10	274	WF-75-1.75	158
CAT50SLN1-1/4	139	EPM-2590B	246	EPM-CIRIB355	255	EHD-S13	274	WF-C1-75-1.75	158
CAT50SLN3/4	139	EPM-300IT	257	EPM-CIRIB355	255	EHD-S2	274	WF-C1-0.5	152
CAT50SLN3/8	139	EPM-30100B	246	EPM-CIRIB355	255	EHD-S3	274	WF-C1-0.75	152
CAT50SLN5/8	139	EPM-3030A	249	EPM-CIRIB355	255	EHD-S4	274	WF-C1-1.25-1.75	152
DNA11TWA	48	EPM-3030B	246	EPM-CIRIB355	255	EHD-S5	274	WF-C1-1.25-1.75	158
DNA11W	236	EPM-3040A	249	EPM-CIRIB355	255	EHD-S6	274	WF-C1-1.5-1.75	152
DNA16TWA	49, 237	EPM-3040B	246	EPM-CIRIB355	255	EHD-S7	274	WF-C1-1-1.75	152, 158
DNA16W	49, 236	EPM-3060A	249	EPM-CIRIB355	255	EHD-S8	274	WF-C1-2-2	152
DNA20TWA	49, 237	EPM-3060B	246	EPM-CIRIB355	255	EHD-S9	274	WF0.5	152
DNA20W	49, 236	EPM-3060D-480	248	EPM-CIRIB355	255	EHD-SFS200	274	WF0.75-1.5	152
DNA32TWA	49, 237	EPM-3080B	246	EPM-CIRIB355	255	EHT-100	265	WF1.25-1.75	152, 158
DNA32W	49, 236	EPM-3090B	246	EPM-CIRIB355	255	EHT-150	265	WF1.5-1.75	152
ECB-050	260	EPM-3090B	246	EPM-CIRIB355	255	EHT-150L	265	WF1-1.75	152, 158
ECB-05024	260	EPM-30T	255	EPM-CIRIB355	255	EHT-150W	265	WF2	152
ECB-075	260	EPM-400PIM	258	EPM-CIRIB355	255	EHT-300	265		
ECB-07524	260	EPM-40100B	246	EPM-CIRIB355	255	EHT-300L	265		
ECB-120	260	EPM-4040A	249	EPM-CIRIB355	255	EHT-300W	265		
ECB-12024	260	EPM-4040B	246	EPM-CIRIB355	255	EHT-65V	265		
ECB-210	260	EPM-4050A	249	EPM-CIRIB355	255	EHT-72	265		
ECB-21024	260	EPM-4050B	246	EPM-CIRIB355	255	ELM-100	268		
ECB-SP	260	EPM-4050D-480	248	EPM-CIRIB355	255	ELM-1000	268		
ECB-SPF	260	EPM-4060A	249	EPM-CIRIB355	255	ELM-1000V	269		
ECE-100	266	EPM-4060B	246	EPM-CIRIB355	255	ELM-2000	268		
ECE-150	266	EPM-4060D-480	248	EPM-CIRIB355	255	ELM-300	268		
ECE-208	266	EPM-4080B	246	EPM-CIRIB355	255	ELM-3000	268		
ECE-212	266	EPM-4080D-480	248	EPM-CIRIB355	255	ELM-300V	269		
ECE-300AL	242	EPM-4090B	246	EPM-CIRIB355	255	ELM-600	268		
ECE-300ALL	242	EPM-470IT	257	EPM-CIRIB355	255	ELM-600V	269		
ECE-300B	242	EPM-500V2	253	EPM-CIRIB355	255	ELM-SB1000	269		
ECE-330AL	242	EPM-500V4	253	EPM-CIRIB355	255	ELM-SB10000	269		
		EPM-50100B	246	EPM-CIRIB355	255	ELM-SB13500	269		

# IT'S NOT JUST SHRINKFIT, IT'S SHRINKLOCKED!



**SHRINK LOCKED**™  
WITH FORMULA TTG 594



Enjoy the peace of mind knowing your tool will never slip, even in the most aggressive applications.

ShrinkLOCKED tool holders are enhanced with our patented TTG-594 compound for 6X the gripping force of standard shrink fit holders.



**SHRINK LOCKED**™  
WITH FORMULA TTG 594

## Why Try ShrinkLOCKED?

- Run harder – higher speeds and feeds.
- Never spin or pull out a cutting tool.
- No modification to your tool shank required.
- No impact to accuracy or tool changes.
- Locked drive on standard carbide round shanks.

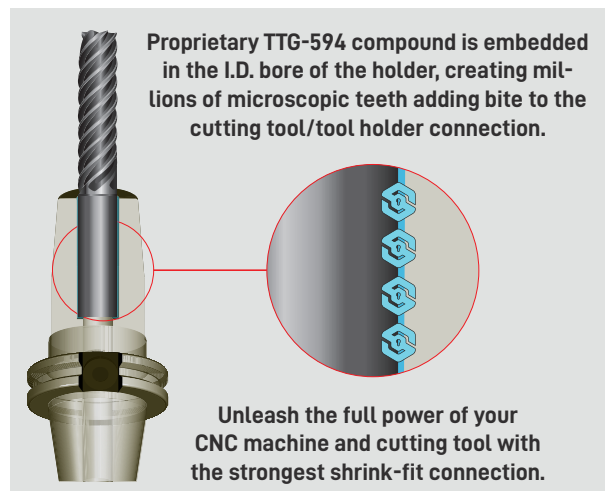

# DELIVERING LIVE ON-SITE TOOL DEMOS & TRAINING



ShrinkFIT Tool Holders and Machines



Magnetic Workholding & Lifting Solutions

- ▶ Techniks & Parlec branded CNC toolholders & Accessories
- ▶ ShrinkFIT Solutions
- ▶ Magnetic CNC Workholding & Material Handling Solutions
- ▶ sPINner small parts deburring
- ▶ AND MORE! Call to request specific tools.



Techniks is a proud member of Techniks Tool Group.

**TOOLING SOLUTIONS  
FROM SPINDLE TO WORKPIECE**

Connect with Techniks Tool Group

